

Environment & Health Protection Guidelines: Onsite Wastewater Management

Guidelines

June 2023



Environment & Health Protection Guidelines: On-site Wastewater Management

2023

ACCESS TO SERVICES

The Office of Local Government is located at:

Street Address: Levels 1 & 2, 5 O’Keefe Avenue, NOWRA NSW 2541

Postal Address: Locked Bag 3015, Nowra, NSW 2541

Phone: 02 4428 4100

Fax: 02 4428 4199

TTY: 02 4428 4209

Email : olg@olg.nsw.gov.au

Website: www.olg.nsw.gov.au

OFFICE HOURS

Monday to Friday

9.00am to 5.00pm

(Special arrangements may be made if these hours are unsuitable)

All offices are wheelchair accessible

ALTERNATIVE MEDIA PUBLICATIONS

Special arrangements can be made for our publications to be provided in large print or an alternative media format. If you need this service, please contact Client Services on 02 4428 4100.

DISCLAIMER

While every effort has been made to ensure the accuracy of the information in this publication, the Office of Local Government expressly disclaims any liability to any person in respect of anything done or not done as a result of the contents of the publication or the data provided.

© NSW Office of Local Government, Department of Planning and Environment 2023

Produced by the NSW Office of Local Government, Department of Planning and Environment

ACKNOWLEDGEMENTS

The Environment & Health Protection Guidelines: Onsite Wastewater Management (“the Guidelines”) was developed by Whitehead & Associates Environmental Consultants Pty Ltd under the guidance and direction of the NSW Office of Local Government, NSW Health, the Department of Planning and Environment – Water (Town Water Risk Reduction Program) and WaterNSW. The Office of Local Government would also like to acknowledge the local councils, wastewater consultants and other stakeholders who provided valuable feedback during the development of these Guidelines.

Document control

Version	Document Owner	Amendments	Approved	Date of effect
1998	Department of Local Government	Original		
2023	Office of Local Government	Review and update.		

Contents

List of Acronyms	7
Background	10
Section 1. Legislative Responsibilities	14
1.1 Local Government Act 1993.....	14
1.2 Local Government (General) Regulation 2021.....	15
1.3 Protection of the Environment Operations Act 1997.....	15
1.4 Environmental Planning and Assessment Act 1979	16
1.5 Onsite Wastewater Management and Development Planning	16
Section 2. Updating an Onsite Wastewater Management Strategy	20
2.1 The Strategy	20
Section 3. Operational Strategies	24
3.1 Regulation	24
3.2 Responsibilities.....	24
3.3 Regulatory Processes.....	27
Section 4. Site and Soil Evaluation	36
4.1 Introduction	36
4.2 Desktop Study	38
4.3 Site and Soil Evaluation.....	42
4.4 Site and Soil Evaluation Requirements for Tiny Houses	64
Section 5. Onsite Wastewater Management System Options	67
5.1 Introduction	67
5.2 Onsite Wastewater Treatment Performance Standards	71
5.3 Primary Treatment Systems.....	75
5.4 Secondary and Advanced Secondary Treatment Systems.....	79
5.5 Tertiary Treatment Processes	83
5.6 Passive Polishing Systems	85
5.7 Onsite Effluent Application Options.....	88

5.8	Partial Onsite Wastewater Management	94
5.9	Emerging Onsite Wastewater Management Systems	97
Section 6. Onsite Wastewater Management System Design		99
6.1	Wastewater Generation	99
6.2	System-Specific Design Considerations	101
6.3	Onsite Effluent Application Area Sizing	105
6.4	Linear Loading Rate	112
6.5	Drainage and Dosing Methods.....	116
6.6	Distribution Methods	118
6.7	Viral Die-Off Modelling	118
6.8	Raised Onsite Effluent Application Systems	119
6.9	Soil Amelioration	119
Section 7. Onsite Wastewater Management System Selection.....		124
7.1	Introduction	124
7.2	Constraints and System Selection	125
Glossary		136
Bibliography: References and Further Reading.....		145
Appendix 1. Model Site Report.....		151
Appendix 2. Model Approval to Install/ Alter Conditions		159
Appendix 3. Model Approval to Operate Conditions		167
Appendix 4. Onsite Wastewater Management Installation		175
Appendix 5. Onsite Wastewater Management System Operation & Maintenance		183
Appendix 6. Onsite Wastewater Management Design Worked Examples & Case Studies.....		191
Appendix 7. Onsite Wastewater Management Checklists		210
Appendix 8. Model Onsite Wastewater Management Strategy.....		230

List of Figures

Figure 3-1: Application for Approval to Install/Modify	28
Figure 3-2: Installation Inspection.....	31
Figure 4-1: Point of Application in EAA Systems and Minimum Separation Depths.....	54
Figure 4-2: Appropriate Levels of Soil Investigation for Different EAA Systems.....	55
Figure 5-1: Total Onsite Wastewater Management.....	67
Figure 5-2: Waste Streams of Domestic Wastewater	68
Figure 5-3: Typical Schematic of Septic Tank System.....	76
Figure 5-4: Typical Schematic of a WCS.....	77
Figure 5-5: Typical Schematic of a WCT System.....	78
Figure 5-6: Typical Schematic of an AWTS.....	80
Figure 5-7: Typical Schematic of an Aerobic Sand Filter System.....	81
Figure 5-8: Typical Schematic of a Constructed Wetland System.....	82
Figure 5-9: Typical Schematic of a GTS.....	83
Figure 5-10: Typical Schematic of a Mound System.....	86
Figure 5-11: Typical Schematic of a Bottomless (Unlined) Sand Filter	86
Figure 5-12: Typical Schematic of a Two-Stage Proprietary Geotextile System Showing the Advanced Enviro-Septic™ (left) and the Eljen Geotextile Sand Filter (right) Systems	87
Figure 5-13: Typical Schematic of a Recirculating Evapotranspiration Channel System	87
Figure 5-14: Typical Schematic of an Amended Soil Mound System	88
Figure 5-15: Typical Schematic of an Absorption System (Trench and Bed)	90
Figure 5-16: Typical Schematic of an ETA Bed	90
Figure 5-17: Typical Schematic of a Wick System	91
Figure 5-18: Typical Schematic of an LPED System	92
Figure 5-19: Typical Schematic of a Subsurface Irrigation System.....	92
Figure 5-20: Typical Schematic of a Surface Irrigation System	93
Figure 5-21: Typical Schematic of Level 1 Greywater Recycling Options	94
Figure 6-1: Effluent Application Water Balance.....	109
Figure 6-2: Effluent Application Nutrient Balance	111
Figure 6-3: Plan View Schematic of the Fate and Transport of Nutrients Under an EAA.....	112
Figure 6-4: Soil Ameliorant Guide	120
Figure 6-5: Typical Schematic of a Stormwater Diversion Device.....	121

List of Tables

Table 1-1: Planning Processes – Key Stages and Recommended Levels of Assessment	17
Table 3-1: Stakeholder Responsibilities	24
Table 3-2: Application Assessment Checklist – Install/ Construct/ Alter OWM	29
Table 4-1: Site Features - Risk Ratings for OWMSs	44
Table 4-2: Appropriate Buffer Ranges for Sensitive Receptors.....	48
Table 4-3: Constraint Scale Ranges	49
Table 4-4: Soil Features - Risk Ratings for OWMSs	57
Table 4-5: Soil Test Data Required for Different Situations.....	60
Table 4-6: Soil Permeability Categories Based on Soil Texture and Soil Structure	62
Table 4-7: Typical P-sorption Values	63
Table 4-8: Tiny House Required Bed Lengths	65
Table 5-1: Constituents in Untreated Domestic Wastewater.....	69
Table 5-2: Wastewater Treatment Performance Standards and Suitable Treatment System and Effluent Application Options.....	73
Table 5-3: GTS Quality Performance Standards and Suitable Recycling Options for Single Dwelling Households.....	75
Table 6-1: Design Occupancy	99
Table 6-2: Design Flow Allowances	100
Table 6-3: Minimum Operational Septic Tank Capacity	101
Table 6-4: Design Loading/ Irrigation Rates (DLR/ DIR) for Effluent Application Systems	106
Table 6-5: Linear Loading Rates	114
Table 7-1: Constraints to Total OWM.....	125
Table 7-2: Advantages and Limitations of Conventional OWMS Components	130

List of Acronyms

ARA	Appropriate regulatory authority
ASMFS	Aerobic sand and media filter system
AWTS	Aerated wastewater treatment system
BOD/BOD ₅	Biochemical oxygen demand (5-day BOD)
BoM	Bureau of Meteorology
CC	Construction certificate
CDC	Complying development certificate
CEC	Cation exchange capacity
CFU	Colony forming units
COC	Constituent of concern
CES	Common effluent system
CT	Composting toilet
DA	Development application
DCP	Development control plan
DIR	Design irrigation rate
DLR	Design loading rate
DO	Dissolved oxygen
EAA	Effluent application area
EAT	Emerson Aggregate Test (also MEAT - modified EAT)
EC	Electrical conductivity
EMA	Effluent management area
EP	Equivalent population
EPA	Environment Protection Authority
ESP	Exchangeable sodium percentage
ETA	Evapotranspiration absorption
FC	Faecal coliforms
FOG	Fats, oils and greases
GDD	Greywater diversion device
GPD	Greywater processing device
GTS	Greywater treatment system
HRT	Hydraulic retention time
HWSF	Human waste storage facility
HWTD	Human waste treatment device
K _{sat}	Saturated hydraulic conductivity
LEP	Local environmental plan
LES	Local environmental study
LGA	Local government area
LPED	Low pressure effluent distribution

LTAR	Long term acceptance rate
N	Nitrogen
NUA	Nutrient uptake area
O ₃	Ozone
OSM/OSSM	Onsite sewage management, see OWM instead
OWM	Onsite wastewater management
OWMS	Onsite wastewater management system
O&M	Operation and maintenance
P	Phosphorus
POAA	Priority oyster aquaculture area
P-sorb	Phosphorus sorption ratio
SAR/SAR ₅	Sodium adsorption ratio
SEPS	Sewage ejection pump station
SI	Surface irrigation
SILO	Scientific Information for Land Owners
SMF	Sewage management facility
SS	Suspended solids
SSE	Site and soil evaluation
SSI	Subsurface irrigation
STS	Secondary treatment system
TN	Total nitrogen
TOSM	Total onsite sewage management, see TOWM
TOWM	Total onsite wastewater management
TP	Total phosphorus
TSS	Total suspended solids
UV	Ultra-violet
WCS	Wet composting system
WCT/WCTS	Waterless composting toilet system
WMR	Wastewater management report
Legislation (NSW)	
EP&A Act	<i>Environmental Planning and Assessment Act 1979</i>
LG Act	<i>Local Government Act 1993</i>
LG Regulation	Local Government (General) Regulation 2021
POEO Act	<i>Protection of the Environment Operations Act 1997</i>

Background

Background

The 'Environment & Health Protection Guidelines: On-site Wastewater Management' (the Guidelines) have been published to assist councils in NSW to manage and regulate Onsite Wastewater Management Systems (OWMS)

Background

The *Environment & Health Protection Guidelines: Onsite Wastewater Management* (“the Guidelines”) have been published to assist councils in NSW to manage and regulate Onsite Wastewater Management Systems (OWMS) in a systematic way that is cost-effective, consistent with regulatory standards and Government policies, and in accordance with current best practice. The Guidelines aim to reduce the risk to public health and the environment.

OWMS include all systems operated with approval under section 68 of the *Local Government Act 1993* (LG Act), which includes, but is not limited to, single households, motels, caravan parks and private resorts. Consequently, these systems are a significant infrastructure asset in the State.

The Guidelines have been revised and updated to help raise professional standards across the whole Onsite Wastewater Management (OWM) sector. They outline best practice which should be followed by designers, installers, service technicians and regulators and provide guidance on regulatory expectations and appropriate levels of service delivery. Where the level of service outlined in the Guidelines is delivered by designers, installers and service technicians and is required and appropriately enforced by regulators; homeowners and occupiers can be reassured that public and environmental health are appropriately protected. Whilst it is recognised that cost effective service delivery is important, it benefits no one where corners are cut to save money and it is the responsibility of all professionals involved with the industry to both maintain appropriate standards and educate the wider public in the necessity and associated cost of doing so.

Purpose

These guidelines have been developed to assist councils, county councils and joint organisations to comply with statutory requirements under the LG Act and LG Regulation, and replace the *Environment & Health Protection Guidelines: Onsite Sewage Management for Single Households (1998)*.

Council officers are encouraged to establish communication networks with other councils and the wastewater industry to keep up to date with research and new technologies.

The Guidelines discuss:

- Performance standards for OWMS;
- Systematic Site and Soil Evaluation (SSE);
- Simplification of the approval of OWM by:
 - Setting out a process for approving OWMS;
 - Providing detailed information to assist councils in their approval of OWMS;
 - Providing practical advice on the update of the council’s OWM strategy
- Technologies for onsite wastewater treatment and effluent management.

Wastewater Management Performance Standards

LG Regulation specifies that the OWMS approved under item 5 of Part C of the Table to section 68 of the LG Act – as well as any building or work associated or carried out in connection with the activity – must comply with the performance standards established by the LG Regulation or Act. These performance standards provide the statutory framework against which OWMS should be assessed.

The recommendations in the Guidelines relating to the interpretation and assessment of compliance with performance standards are necessarily generalised and based on current, imperfect knowledge. It is a matter for the council, as the determining authority, to be satisfied that an approval should be issued. A well-founded alternative approach that conflicts with particular recommendations of the Guidelines may be acceptable, and can be approved by a council, provided that the applicant for approval can demonstrate, to the council's satisfaction, that the system meets the performance standards for wastewater management specified in the LG Regulation, and satisfies the requirements of all relevant statutory authorities.

What is domestic wastewater and onsite wastewater management?

Domestic wastewaters are those originating from households or personal activities including water closets, urinals, kitchens, bathrooms and laundries. Domestic wastewater can include wastewater flows from facilities serving staff, employees, residents or guests in institutional, industrial, commercial or recreational establishments, but excludes trade wastes from industrial, commercial or home business sources.

This Guideline outlines the regulation and management of treatment systems capable of treating domestic wastewater with a daily flow of up to 5,000L/day.

This is to align with the definition as indicated in AS 1546.3:2017 Onsite domestic wastewater treatment units Part 3 Secondary treatment systems (Standards Australia 2017b) and to better cover the majority of OWMS regulated by local councils.

Note: Other terms have been used for OWM in the past and in other documents, including onsite sewage management, onsite system, sewage and sewer management facility. In this version of the Guideline the terms used will be OWM and OWMS and wastewater.

Using the Guidelines

The Guidelines consist of three parts:

Section 1, Section 2 and Section 3, focus on the council's strategic wastewater management functions. The legislative framework for councils' wastewater management functions is explained and guidance is provided for the process of developing and updating an integrated program of planning, assessment, monitoring and regulation.

Section 4, Section 5, Section 6 and Section 7 provide technical guidance on the application of the OWM performance standards for site evaluation, wastewater treatment and effluent application systems. Information is included to assist the assessment of OWMSs for particular purposes including larger systems up to 5,000L/day servicing resorts or multiple households.

Appendices provide checklists and details in addition to the Guideline body.

The Guidelines are management guidelines, not a design and operations manual. It provides guidance on the interpretation of regulatory standards and on practical ways for councils to manage safe and sustainable OWM for their local communities using best practice techniques.

The Guidelines sit beside the relevant Australian Standards and should be used to update local council strategies regarding onsite wastewater management.

Where the Guidelines mention external sources of information, including standards, legislation and references, the updated version of these external sources becomes relevant, when available.

Draft

Section 1: Legislative Responsibilities

Councils are granted responsibilities and powers by NSW state legislation

- Local Government Act 1993
- Local Government (General) Regulation 2021
- Protection of the Environment Operations Act 1997
- Environmental Planning and Assessment Act 1979

Section 1. Legislative Responsibilities

Councils are granted responsibilities and powers by NSW state legislation. Onsite Wastewater Management (OWM) is a fundamental aspect of the environmental assessment, land use planning and development control functions of local councils under the *Environmental Planning and Assessment Act 1979* (EP&A Act) and the *Local Government Act 1993* (LG Act).

In NSW the LG Act and LG Regulation are the principal statutory source of local government onsite wastewater management duties, functions and powers. The EP&A Act, *Protection of the Environment Operations Act 1997* (POEO Act), *Public Health Act 2010* and other special purpose legislation, also confer specific and general onsite wastewater management related functions and powers on councils, including environmental planning and pollution control.

Local councils are the authority responsible for approval and regulation of OWMS in NSW, with the exception of accreditation of Sewage Management Facilities (SMF), which is managed by NSW Health (see Section 1.1), and OWMS classed as scheduled activities, which are regulated by the NSW Environmental Protection Authority (EPA) (see Section 1.3). The approval and regulation of OWMS on land owned by the state or federal governments is managed by the relevant department and Minister.

1.1 Local Government Act 1993

The LG Act outlines councils' functions, including service (non-regulatory) (Chapter 6), regulatory (Chapter 7) or ancillary (Chapter 8). Ancillary functions are those functions that assist the carrying out of a council's service and regulatory functions, including entry on to land (s. 191-201). Other relevant matters included in the LG Act include strategic planning, conduct of staff, financing for council programs, administration, offences and enforcement.

Regulatory functions conferred by the LG Act on councils relate to Approvals (Chapter 7, Part 1) and Orders (Chapter 7, Part 2).

Approvals

Chapter 7, Part 1 sets out what activities require council approval (s. 68-68B); Crown activities and exemptions (s. 69-74); making and determining applications for approvals (s. 75-113); and the accreditation of components, processes and designs (s. 120-123B). Prior approval of the council is required under section 68 before certain activities can be carried out, including:

- Part C (5) Install, construct or alter a waste treatment device or a human waste storage facility or a drain connected to any such device or facility;
- Part C (6) Operate a system of sewage management (within the meaning of section 68A);
- Part F (10) Carry out an activity prescribed by the regulations or an activity of a class or description prescribed by the regulations.

Orders

Chapter 7, Part 2 (s. 124-167) provides a legal framework for orders to be given and the procedures to be followed in giving those orders. Section 124 includes a table of orders that can be given, including the required action, in what circumstances it can be given and who it can be given to. Offences can relate to failure to obtain approval, to comply with the conditions of approval or to comply with an order given (s. 626-628).

1.2 Local Government (General) Regulation 2021

The LG Regulation sets out specific requirements for onsite wastewater management approvals, including:

- definitions of terms,
- documents required to be submitted with applications, including a site plan and assessment,
- matters to be taken into consideration in determining applications,
- standards to be met for approval and conditions of approvals,
- performance standards for Sewage Management Facilities (SMF), closets for certain toilet systems and cesspits, and operation of SMF, and
- accreditation of SMF by the NSW Ministry of Health and the exemption of certain facilities from accreditation. An exempt system is still required to meet the performance requirements for the SMF and operation of the SMF.

The LG Regulation also sets out that approval is required for a domestic greywater diversion and situations where prior approval of the council is not required. Note that the definition of greywater for domestic greywater diversion does not include kitchen wastewater. The LG Regulation also provides further detail on the giving of orders and lists the offences under the LG Act and their relevant penalty value.

The performance standards for the operation of a system of sewage management underpin this Guideline and set the requirements for installation, construction and alteration and operation of OWMs. In particular, section 44 of the LG Regulation states:

(1) A system of sewage management must be operated in a manner that achieves the following performance standards:

- a) the prevention of the spread of disease by microorganisms;
- b) the prevention of the spread of foul odours;
- c) the prevention of contamination of water;
- d) the prevention of degradation of soil and vegetation;
- e) the discouragement of insects and vermin;
- f) ensuring that persons do not come into contact with untreated sewage or effluent (whether treated or not) in their ordinary activities on the premises concerned;
- g) the minimisation of any adverse impacts on the amenity of the premises and surrounding lands; and
- h) if appropriate, provision for the re-use of resources (including nutrients, organic matter and water).

1.3 Protection of the Environment Operations Act 1997

The POEO Act is the key piece of environment protection legislation used by the NSW Environment Protection Authority (EPA) and other public authorities to prevent, control and investigate pollution in NSW. The POEO Act nominates that local councils are the Appropriate Regulatory Authorities (ARAs) for environmental protection for non-scheduled activities, including OWM, in each Local Government Area (LGA) (s. 6), along with activities that the EPA and other ARAs are responsible for, including scheduled activities. Land owned by the state or federal governments is managed by the relevant department and Minister.

Environmental protection licences are issued by the EPA under the POEO Act for scheduled activities, including wastewater treatment systems with an intended processing capacity of more than 750

kilolitres of wastewater per day (or receive wastewater from premises occupied by more than 2,500 EP). Other systems of wastewater management used on premises already subject to an environmental protection licence are also regulated by EPA. All OWMS that don't meet the above criteria are regulated by the local council under the LG Act and LG Regulation.

Being an ARA delegates certain enforcement powers under the POEO Act and Regulations. Councils can delegate this power to authorised council officers (s. 187-189A), including the power to issue environment protection notices under Chapter 4 (s. 89-113), including clean-up and prevention notices, but excluding prohibition notices. Councils can recover the costs of compliance actions. This can be an effective tool for problem OWMSs at risk of polluting waters or land.

1.4 Environmental Planning and Assessment Act 1979

Development and land use can have impacts beyond the physical boundaries of a site. The various phases of land use planning and development offer a number of opportunities to minimise the negative impacts of human activity on neighbours and the environment.

The EP&A Act and Regulations direct the development processes across the State, being strategic and prescriptive. OWM should be considered as part of essential infrastructure servicing for any land that is not sewered at the strategic level, such as rural residential release strategies, and as part of rezoning of unsewered land in a Local Environmental Plan (LEP).

The LEP sets out development that is exempt, complying and requires development consent, being a Development Application (DA), for each LEP land zone within the LGA. Development Control Plans (DCPs) provide more detailed requirements for certain matters, which can include onsite wastewater management, to support a LEP.

OWM should be further considered when a DA is submitted for the subdivision of land or for the construction of an individual dwelling or development on single lot.

Under s. 4.12(3-6) of the EP&A Act certain councils have now begun to take advantage of the [NSW Planning Portal](#) to lodge certain LG Act s68 applications in the same DA, including Part C(5) and Part F(10), being OWM and greywater diversions, when the council is the consent authority for both applications.

For development on land that falls within certain catchments, including the Sydney Drinking Water Catchment, reference should be made to Part 6.5 of State Environmental Planning Policy (Biodiversity and Conservation) 2021, which supersedes the repealed State Environmental Planning Policy (Sydney Drinking Water Catchment) 2011. For all other drinking water catchments, the local water authority should be contacted to confirm their requirements.

1.5 Onsite Wastewater Management and Development Planning

Table 1-1 indicates the different stages in the planning/ development process when the issue of OWM should be addressed. It shows the level of assessment considered appropriate for each stage and the primary purposes of each level of assessment.

In determining the appropriate requirements for a new development, the council should consider the availability of local resources to service and provide regulatory oversight of the proposed system(s).

Table 1-1: Planning Processes – Key Stages and Recommended Levels of Assessment

Stage in Planning Process	Possible Scales	Level of Assessment Required	Purpose
Regional strategies and Rural residential release strategies	<ul style="list-style-type: none"> ● Planning region including multiple adjoining LGAs ● Catchment wide (prepared by multiple adjoining local councils) ● Multiple LGAs ● One LGA ● Part of an LGA 	<ul style="list-style-type: none"> ● Broad evaluation ● Desktop analysis based on soil landscape maps, GIS (Geographic Information Systems), reports, studies and local knowledge ● Representative testing of different soil landscape types (if necessary) 	<ul style="list-style-type: none"> ● Guide the strategic long-term planning in key regions of NSW ● Inform State infrastructure planning ● Determine demand for, and capacity of, an area to sustain residential development, including whether OWM is viable or whether centralised wastewater management is required ● For large subdivisions or for development in environmentally sensitive areas or near important agriculture, tourist or mining areas ● Capability for OWM may be: <ul style="list-style-type: none"> ○ not capable ○ conditionally capable ○ capable due to the level of soil and landscape constraints ● Assess cumulative impacts and allow for more effective management
Local Environmental Plan (LEP) / Local Environmental Study (LES)	<ul style="list-style-type: none"> ● Catchment-wide (prepared by multiple adjoining local councils) ● Multiple LGAs ● One LGA ● LES - Part of an LGA ● Rezoning specific site 	<ul style="list-style-type: none"> ● As for rural residential release strategies ● Detailed Site and Soil Evaluation (SSE) (see Section 4) for site-specific re-zonings 	<ul style="list-style-type: none"> ● Sets out development that is exempt, complying and requires development consent, being a DA, for each zone within the LGA ● Identify areas that should be eliminated from development due to unsuitability for OWM and sewer servicing ● Identify densities that can be sustained in different landscapes ● Determine minimum and average lot sizes and identify minimum treatment technologies and OWM methods ● Establish minimum performance standards/ criteria
Development control plan	<ul style="list-style-type: none"> ● One LGA ● Part of an LGA ● Specific site 	<ul style="list-style-type: none"> ● As for LEPs ● Detailed SSE (see Section 4) if DCP is to define OWM areas 	<ul style="list-style-type: none"> ● Provide more detailed requirements to support a LEP ● Identify appropriate minimum treatment technologies and OWM methods to mitigate identified constraints

Stage in Planning Process	Possible Scales	Level of Assessment Required	Purpose
			<ul style="list-style-type: none"> Establish prescriptive performance standards/ criteria Define OWM locations
Development application - subdivision	<ul style="list-style-type: none"> Specific site 	<ul style="list-style-type: none"> Detailed SSE (see Section 4) if not done at LEP stage 	<ul style="list-style-type: none"> Determine appropriate density, internal road and lot layouts based on constraints Large subdivisions – assess capacity to incorporate community wastewater management rather than individual OWM Assessments based on nominal 4-bedroom dwelling, buffers and open space requirements separate to Effluent Application Area (EAA) Select minimum treatment/ OWM method, nominate available EAAs and reserve areas, if required
Development application - dwelling (new or alterations)	<ul style="list-style-type: none"> Individual lot 	<ul style="list-style-type: none"> Site and soil evaluation (see Section 4) 	<ul style="list-style-type: none"> Indicate precise site layout including dwelling, other improvements, buffers, open space and EAA(s) and reserve area(s) if required
Change of use	<ul style="list-style-type: none"> Individual lot 	<ul style="list-style-type: none"> Site and soil evaluation (see Section 4) 	<ul style="list-style-type: none"> Indicate precise site layout including dwelling, other improvements, buffers, open space and EAA(s) and reserve area(s) if required

Section 2: Updating an Onsite Wastewater Management Strategy

Councils are encouraged to develop an OWM Strategy to provide guidance on OWM within their LGA

Section 2. Updating an Onsite Wastewater Management Strategy

2.1 The Strategy

Councils are encouraged to develop an OWM Strategy (“Strategy”) to provide guidance on OWM within their LGA. Many councils have already developed a Strategy in response to the *Environment & Health Protection Guidelines: Onsite Sewage Management for Single Households (1998)*, but the regular review and updating of Strategies is encouraged to allow the Strategies to become more useful tools for operational management of new and existing OWMSs. Strategies can provide guidance on development, local approvals and regulatory processes and how they will be implemented and funded. Strategies can provide owners and developers with guidance on their responsibilities, details required to support an application and how a particular council will implement the many regulations and guidance documents for OWM in their LGA.

Review of other similar councils’ OWM Strategies may help identify possible improvements to be incorporated into any updates. Establishing regional groups of councils can be effective in providing support in the regulation of OWM. Refer to Appendix 8 for a model OWM Strategy.

2.1.1 Useful Tools

Useful tools that could be incorporated into updated Strategies include:

- **Monitoring Program (Existing Systems):**
 - Role of the monitoring program. Ongoing management and education of owners and operators of OWMSs;
 - Performance standards. Existing OWMSs should comply with the performance standards in LG Regulation section 44 and any installation approval still in force for the system. Existing systems are not required to meet current design standards unless there is a failure of the system, an alteration to the buildings associated with the system or an alternation to the OWMS, including the buffers to its EAA;
 - Inspection program process. A flow chart can provide a clear and concise display of the steps to be taken during the operational inspection process. This can help with staff confidence and consistency and stakeholder understanding and compliance;
 - Risk categories. Each system should be allocated into a risk category for the monitoring program. Commonly this is low, medium and high risk;
 - Determining risk categories. A table can be used to set out the features and criteria that the risk categories are determined against. Features commonly include buffer distances, limiting site features, lot size, flood risk and level of treatment. Features should also include sensitive receptors relevant to each council area, such as drinking water catchments or oyster aquaculture areas. It can also include the treatment system size or commercial properties. Other factors that might usefully be considered are system age and whether effluent application is to the surface or subsurface. This approach is used to divide systems based on the risk they pose to the environment or human health if they were to fail and their risk of failure. Some councils use a points system for each feature, with an accumulative points tally providing the risk category, while others provide an acceptable range for each feature to set where a system fits within their risk categories and selection of the highest category from these features;

- Inspection frequency. Set out the inspection frequency for each category. Inspection frequency varies from 1-10 years, depending on the risk category and council. Once a risk category has been allocated by the council, some councils allow private assessment of operational condition by nominated plumbers and inspectors to be submitted to the council, while the council runs an audit program to oversee the private assessment process;
- Risk category changes. Review of and changes to risk categories based on management and maintenance, including failing to comply with the performance objectives, conditions of the council approval or NSW Health accreditation. This enables councils to incorporate how an OWMS is managed into the assessed risk category. This can be used effectively in the monitoring of OWM in marginal areas or with OWMSs that may not be well managed, even in low risk settings. An alternative to this is the reduction in risk category for systems that are well maintained over multiple inspections. The criteria for either option must be clearly set out in the Strategy to be fair and equitable and carefully managed;
- **Approvals applications (to install/ construct/ alter and operate OWMS):**
 - Approvals management system (register of approvals);
 - Approval to operate applications and process. Set out the council's process, including applications, fees, inspections and change of ownership;
 - Installation, construction or alteration of OWMS application. Set out the level of detail in the OWM report required to support each development type (see Section 4, depending on the council's determined factors);
 - Subdivisions. Minimum reporting requirements to support subdivision applications and any restrictions that the council feels are relevant, e.g. category 5 or 6 soils require minimum lot sizes of more than 4,000m² or upgrade of existing OWMS to current standards;
 - Constrained sites. Restrictions on designs in certain circumstances (flood prone, bushfire prone, environmentally sensitive sites, highly constrained sites, small lot sizes) i.e. secondary treatment;
 - Common effluent collection, treatment and application systems. List any particular requirements for these systems installed in the LGA;
 - Unacceptable OWMSs in the LGA. List any systems that are not acceptable in the LGA e.g. pit toilets (cesspits), surface spray irrigation, flood irrigation;
 - Cumulative impact risk area. Are any areas identified in the LGA as being at risk of cumulative impacts? These may include areas in proximity to sensitive environmental receptors (i.e. shallow groundwater, drinking water catchments, and priority oyster aquaculture areas) or developments that propose the creation of new dwelling entitlements;
 - Non-domestic OWM. The council's requirements for non-domestic developments involving OWM including information required for applications;
- **Development and OWM**: The requirements for different development application types in non-sewered areas in regards to OWM, including subdivisions, new dwellings, alterations to existing dwellings and change of use of buildings. This should include any impact the development may have on an existing OWMS;
- **Compliance and enforcement**: Refer to the council's compliance and enforcement policy or provide a brief overview. This could include an inspection program flow chart (see Appendix

8) and could reference the NSW Ombudsman 'Enforcement Guidelines for Councils' (2015) and 'EPA Powers and Notices: Guideline for Authorised Officers and Enforcement Officers Under the POEO Act 1997' (NSW EPA 2021);

- **Education of owners/ operators:** Making simple and engaging education materials available to owners and operators of OWMs will improve the overall management of OWMs and can improve compliance. Online resources (webpage, links and downloadable resources) and printed brochures to be able to hand out or post out are simple options for education resources;
- **Financial hardship upgrades:** Some councils provide a statement on how owners facing financial hardship will be assisted, whether it is with concessions on upgrades or financial assistance from the council;
- **Resourcing:** Staffing and fees/ revenue policy. What is funded (staff, vehicles, equipment, training), implementation of revenue raising (annual fee on rates notice) and review (annually with annual budget);
- **Review of Strategy:** Timeframe for review of the Strategy.

The Strategy can refer to documents with greater detail, such as the Standards, these Guidelines or Designing and Installing On-Site Wastewater Systems (WaterNSW 2023a), rather than repeating this material in the Strategy.

Section 3:

Operational Strategies

The performance of OWMS is more variable than centralised sewerage systems as they are operated by individual owners and occupants and service agents

- Regulation
- Responsibilities
- Regulatory Processes

Section 3. Operational Strategies

3.1 Regulation

The performance of OWMS is more variable than centralised sewerage systems as they are operated by individual owners and occupants and service agents, and because performance and accountability requirements are less clearly understood. Councils hold the main regulatory function for OWM in NSW.

Effective council regulation of OWMS requires a planned risk management approach, combining information gathering, community consultation and education, a flexible performance-based system of regulatory controls and efficient cost-effective service programs. The local council should:

- Develop, implement, and regularly review an OWM Strategy, including a program of OSMS audits;
- Consider all relevant issues when approving the installation or operation of OWMS, particularly environment and health issues, both within the site and on a catchment-wide basis;
- Specify site and system-specific conditions of approval to install/ alter or operate an OWMS;
- Check that approval conditions are complied with by appropriate monitoring or auditing;
- Provide on-going owner/ occupant education on issues including:
 - The statutory responsibilities of owners and operators of OWMS;
 - Health and environmental risks associated with system use;
 - General operation and management advice for common systems installed.

3.2 Responsibilities

Council is the responsible authority for the regulation of OWM in their LGA. Each council nominates authorised officers to complete regulatory tasks on their behalf. Table 3-1 sets out the responsibilities of each stakeholder.

Table 3-1: Stakeholder Responsibilities

Stakeholder	Responsibilities
Local council/ regulator	<ul style="list-style-type: none">• General community leadership, land use planning, development control, regulation of activity, and the provision of OWM services• Production of council strategies, policies and guidelines to strategically manage development at all levels, OWM and regulatory programs. Includes OWM Strategy• Management of OWM applications, assessment and approvals with regard to regulatory and legislative framework and requirements• Authorising council officers for regulatory and enforcement duties• Training and resourcing council staff to adequately complete their duties• Development and enforcement of effective and enforceable conditions of consent for approvals to install, alter and operate OWMS

Stakeholder	Responsibilities
	<ul style="list-style-type: none"> ● Engaging relevant professional services for assessments outside of staff training and experience level ● Monitoring and regulating operational OWMSs including administration, inspection, enforcement and revenue raising to fund the program ● Inspection of OWMS installations in accordance with the conditions of consent ● Inspection of operational OWMS including the detection of system failure or non-compliance ● Maintenance of a register of approved OWMSs in the LGA ● Community education (brochures, website) ● Protection of the environment and human health
Developers/ planners/ surveyors	<ul style="list-style-type: none"> ● Following the relevant regulatory and legislative framework and requirements and local council strategies, policies and guidelines relevant to the planned development (subdivision or single lot development) ● Engaging relevant professional services to meet their requirements ● Following professional advice provided ● Applying for and receiving relevant approval prior to works commencing ● Protection of the environment and human health
Owner	<ul style="list-style-type: none"> ● Following the relevant regulatory and legislative framework and requirements and local council strategies, policies and guidelines relevant to the development ● Applying for and receiving relevant approval prior to activity commencing (installation, modification or operation of OWMS) ● Engaging relevant professional services to meet their requirements including designers, plumbers/ drainers and service agents ● Following professional advice provided ● Design, installation and management of OWMSs on their property to meet the required performance objectives and conditions of approval ● Engagement of professionals and service agents where required for the management and repairs to OWMSs ● Maintain and operate OWMS on their property, including awareness of operation and maintenance requirements for their system ● Supply service reports (if relevant) to council within 14 days of service (service agent should do this on owner/ occupant's behalf) ● Retain relevant records for the OWMS installed on their property ● Education of occupants on safe operation of installed OWMS ● Protection of the environment and human health
Occupants	<ul style="list-style-type: none"> ● Safe operation and relevant maintenance of installed OWMS ● Identification of problems with OWMS ● Notification of relevant person to rectify problems (owner, real estate property manager) ● Protection of the environment and human health
Designers/ site and soil evaluators	<ul style="list-style-type: none"> ● Have suitable and relevant qualifications and experience in OWMS design principles ● Follow the relevant regulatory and legislative framework and requirements, standards, guidelines and local council strategies, policies and guidelines relevant to the development ● Consult with and advise their client

Stakeholder	Responsibilities
	<ul style="list-style-type: none"> ● Complete a suitable site and soil assessment and OWMS design for the site including appropriate information to ensure installer can install the approved design, liaise with the installer ● Have Professional Indemnity insurance to cover their work
Installers	<ul style="list-style-type: none"> ● Having relevant licenses to complete the installation ● Having the relevant training, experience and agreement with the manufacturer to install the OWMS design ● Installation of approved design or gaining suitable authorisation to install an altered design in consultation with the council and the designer ● Liaise with the designer ● Notification of council for regulatory inspection during installation ● Compliance with relevant accreditation conditions ● Provision of a commissioning certificate or installation certificate to the owner and the council ● Provision of a “as built” plan to owner and the council following installation
Service providers/ service agents/ pump-out contractors	<ul style="list-style-type: none"> ● Suitable product knowledge and training in servicing and maintenance and experience in accordance with NSW Health Advisory Note 5 (2018) or as revised ● Understand and implement the operation and maintenance requirements of systems serviced, following the manufacturer’s service requirements as set out in the service manual ● Be either employed or authorised by the manufacturer ● When maintaining or servicing a system, install replacement parts at least to the minimum specification ● Compliance with relevant accreditation conditions ● Suitable reporting to owner and council ● Supply service reports (if relevant) to the owner/ occupants and council within 14 days of service (service agent should do this on owner/ occupant’s behalf) ● Retain records of all services for at least two years ● Notify the council if the owner/ occupier doesn’t accept or action recommended remedial works ● Engage a contractor with a suitable liquid waste license and equipment for pump-out of scum/ sludge and septage and material to be taken to approved facility ● Not perform electrical work or enter confined spaces unless qualified to do so ● Protection of the environment and human health
NSW Health	<ul style="list-style-type: none"> ● Assessment and accreditation of commercially available human waste treatment devices (secondary treatment systems, septic tanks, greywater treatment systems, etc.) ● Provision of health advisory notes on OWM

3.3 Regulatory Processes

3.3.1 Applications and Approvals

OWM Strategy

A council's OWM Strategy and related policies and other documents will guide the allowable development in its LGA, local requirements for OWM and detail of the documents required to be submitted with an application. Further detail is included in Section 2 on updating the OWM strategy and Section 4 on site and soil evaluation. A model OWM Strategy is provided at Appendix 8.

Approvals to install and operate

The application for approval to install, construct or alter a system of sewage management requires an application to be lodged with the council, prior to it being assessed against relevant standards and policies and a determination made, including conditions that need to be met.

The approval to operate a system of sewage management process doesn't require a formal application form or supporting documentation, but can involve the issue of an invoice for the approval, which is taken as an application having been lodged once the invoice is paid (LG Act s. 107A). The approval to operate should include the performance standards (s. 44 of LG Regulation) as part of the conditions, as well as conditions regarding the operation and maintenance of the OWM.

Application Process and Assessment

Figure 3-1 shows a possible application process for an approval to install, construct or alter an OWMS. The council officer will assess the application against the relevant policies and documents and either request additional information, reject the application or approve the application with conditions. An example of an assessment checklist is included in Table 3-2 and examples of approval conditions for installation and operation of an OWMS are included in Appendix 2 and Appendix 3.

Application for Approval to Install / Modify

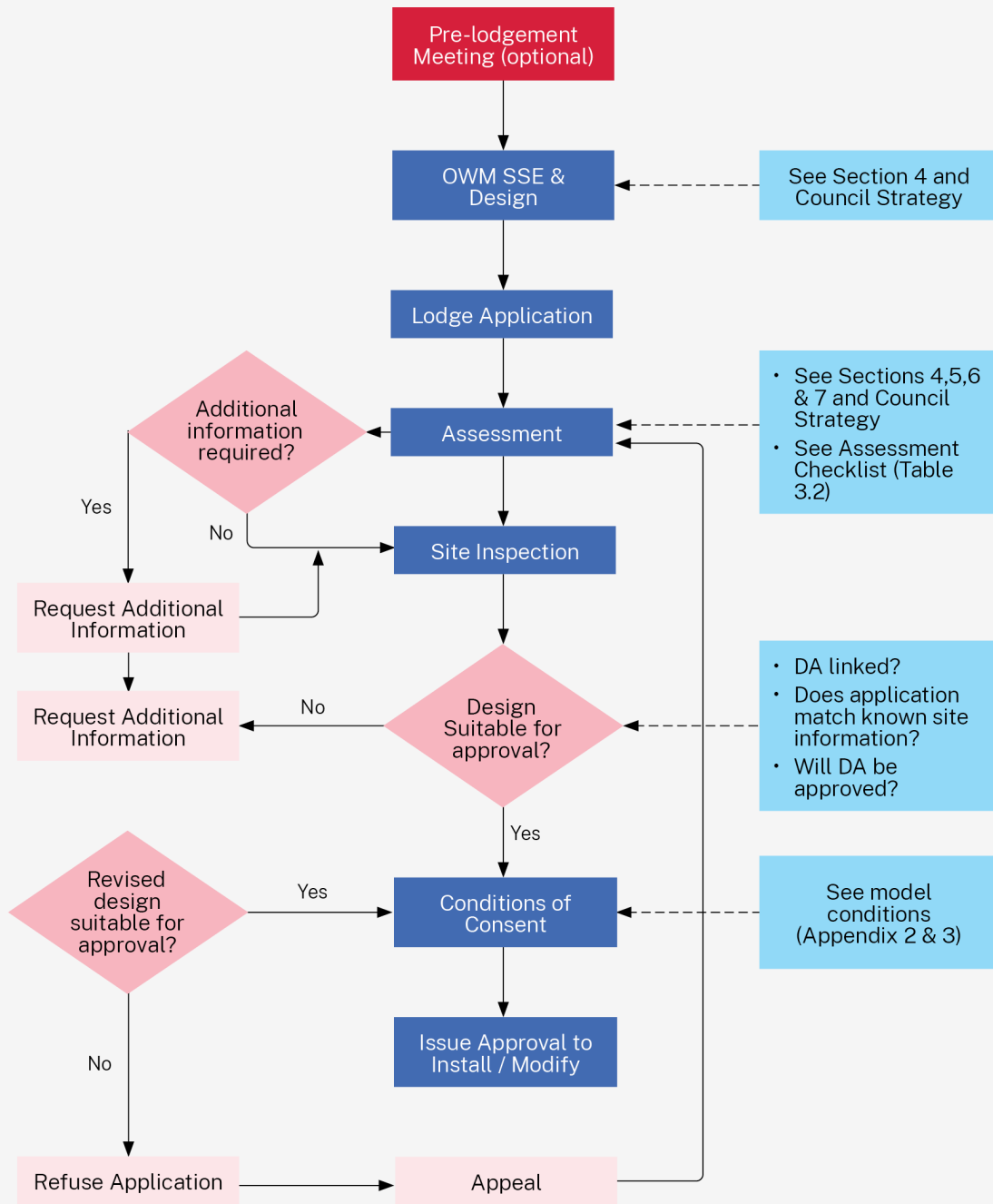

Figure 3-1: Application for Approval to Install/Modify

Table 3-2: Application Assessment Checklist – Install/ Construct/ Alter OWM

Assessment Step	Question
Application and OWM report	Is designer suitably qualified to council's requirements? Does designer have appropriate professional indemnity insurance? Do details in report meet council requirements and LG Regulation (site plan, specifications of SMF, site assessment, design flows, operation and maintenance)?
Site information	Details provided including land use zoning, any existing services and easements?
Development	Type identified?
Sewer	Is connection to sewer available to site? Is it viable?
Design flows	Suitable? Check floorplan and water supply against design.
Site and soil evaluation	Detail meets council requirements and identifies the level of limitation of each feature and any moderate and major constraints? Compare to Table 4-1 and Table 4-4 of Guideline.
Soils	Borehole logs, location on site plan, photos, soil testing results provided?
Sensitive areas	Are any local sensitive areas identified and addressed? e.g. drinking water catchment, priority oyster aquaculture areas, environmentally sensitive, culturally sensitive, vegetation clearing, acid sulfate soils
Mitigation	Mitigation proposed for any moderate or major constraints identified? Do the mitigation measures adequately address the constraints?
Buffers	Does the design meet required buffer distances or provide mitigation for reduced buffers?
Treatment and EAA	Design suitable for site constraints identified? Is all wastewater catered for (black and grey water)?
NSW Health Accreditation	Is it required? Certificate number:
Pump sizing	If pump required, design and pump specifications suitable?
Treatment capacity sizing	Treatment system suitable capacity for design flows?
EAA sizing	Sizing of EAA suitable for site? Are suitable calculations provided (simple, water balance, mound)?
Nutrients	If required, are calculations provided? Is a nutrient uptake area nominated?
Design	Are all design elements present? Flow, sizing, specifications of SMF, mitigation measures, buffers, reserve area, maintenance?
Figures/Site plan	Does the site plan display SMF, EAA, buildings and facilities, environmentally sensitive areas, related drainage lines or pipework, soil borehole locations, slope, buffers, property boundary? EAA schematic or specifications provided?
Site inspection	Does the report accurately represent the site? Is there sufficient area for the EAA as proposed in the report?

Assessment Step	Question
Additional information	<p>If anything is missing, poorly explained or doesn't support the approval of the application, request additional information from the applicant.</p> <p>Does the report include an annotated drawing with sufficient detail to ensure that the installer can install the system as per the approved design?</p>
Referrals	Does the application need to be referred internally or externally?
Risk category	Allocate a risk category to the system as per council's model strategy risk rating.

Accreditation of Sewage Management Facilities

While the installation or modification of SMFs is not permitted without the prior written approval of the local council, the installation or modification of certain SMFs may not be approved unless they are accredited by the NSW Ministry of Health under the LG Regulation. Accreditation is required for those SMFs available by retail purchase of wet composting closets, waterless composting closets, septic tanks, septic closets, holding tanks, collection wells, sewage ejection pump systems and devices that treat sewage using a specific process to produce biosolids and disinfected effluent for reuse (secondary treatment systems). A Certificate of Accreditation must be current, and the conditions of accreditation must be applied to the approval to operate the SMF under the LG Regulation. NSW Ministry of Health has developed accreditation guidelines, health advisory notes and Registers of accredited SMF located on the Onsite Single Domestic Wastewater Management page of the NSW Health website.

Accreditation does not apply to SMF which do not treat domestic sewage, or where there is an average daily flow of exceeding 2,000L, or from a premises to be occupied by more than 10 persons.

Whether or not an accredited SMF is used, the local council is required to assess the suitability of proposed wastewater management arrangements for particular premises and to determine requirements for the safe operation and maintenance of such systems, and for effluent management.

Accreditation Exemption

There is provision within the LG Regulation for a SMF to be installed without accreditation provided that the SMF:

- (a) that is to be installed or constructed as a model for the purposes of testing, or
- (b) that is designed, and is to be constructed, by the owner or occupier of the premises on which it is to be installed, or
- (c) that is designed, by a person other than the owner or occupier of the premises on which it is to be installed, specifically and uniquely for those premises.

In this situation, the council can require that the proposed SMF meets the performance standards of the LG Regulation: relating to the SMF components being durable; expected service life; and details of the installation and construction and anchoring. Alternatively, the council can require the proposed SMF meet the intent of the applicable NSW accreditation guideline.

Installation Inspections

An inspection of any installation or construction and an alteration approval is required to confirm that the works comply with the conditions of approval and the approved design. An example of an installation inspection process flow chart is included at Figure 3-2. The applicant is required to notify the council of the installation and request an inspection. Each council will require an appropriate amount of notice to be given to arrange the inspection, which the applicant should be given in writing, often on their notice of determination correspondence. This is usually 48 hours.

It is important that installation inspections are completed at a time when the inspector can see the entire treatment and effluent application system operating (clean water tested) to demonstrate that all components are working satisfactorily and that even distribution throughout the effluent application system is achieved.

Once the works are completed and all conditions of approval have been met to the council officer's satisfaction, the Approval To Operate (ATO) can be issued with suitable conditions and expiry date. Issue of the ATO may be dependent on the issue of an occupancy certificate for any associated DA or complying development certificate.

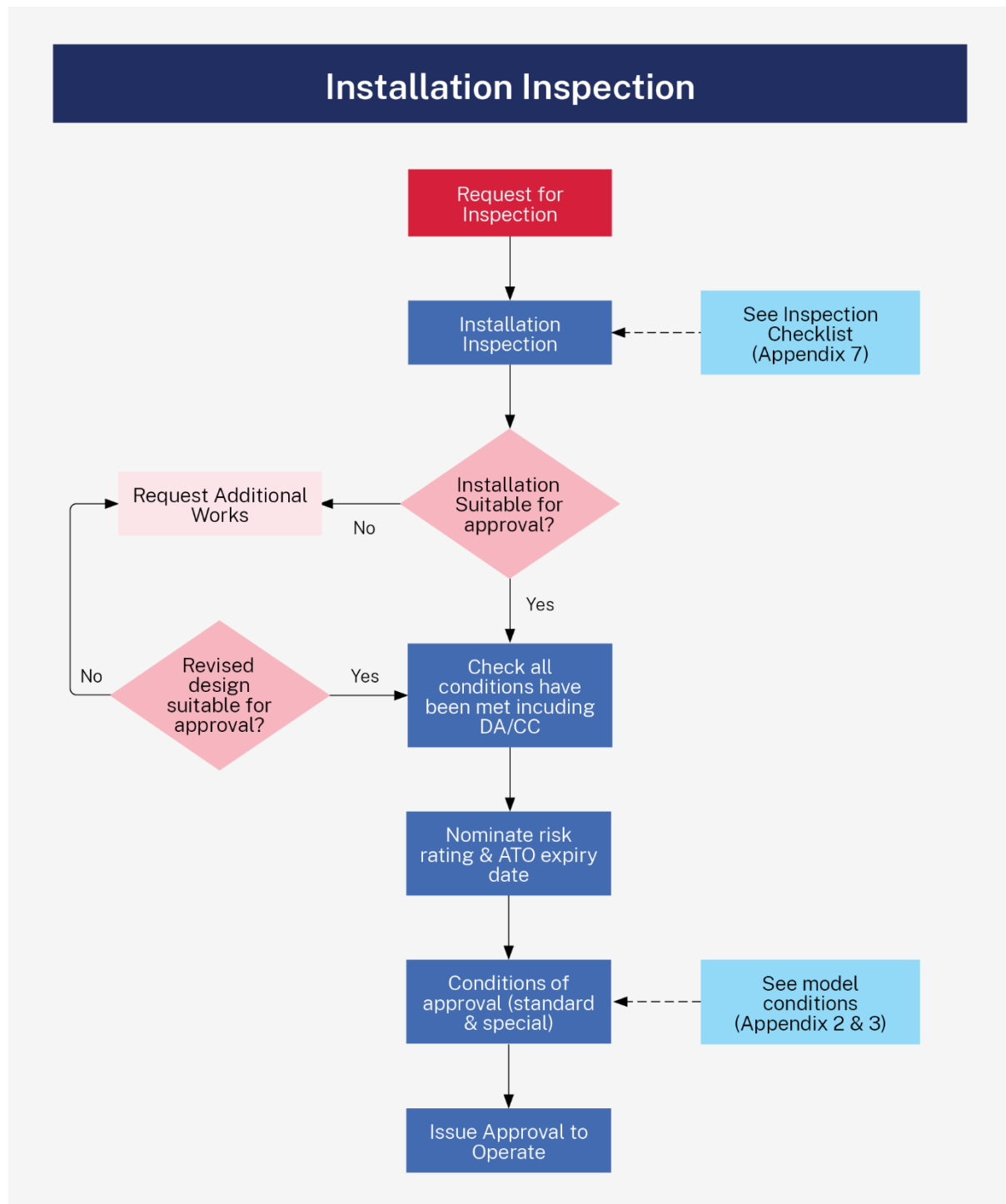

Figure 3-2: Installation Inspection

Approval to Operate

Each OWMS within a LGA requires an ATO unless it is exempt under the LG Regulation. The same exemptions apply to the installation, construction or alteration of an OWMS.

The conditions of consent applied to the ATO must include the relevant conditions of the NSW Health accreditation certificate.

Onsite wastewater management revenue policy

Revenue policy and the allocation of funds for the council's OWM activities are determined by the council in line with the LG Act. Effective wastewater management by council contributes to better environmental management and reduces risks to public health. Councils are encouraged to implement revenue policies that are transparent, and cost-reflective and balance public benefit and user pays principles, using a mix of revenue sources. The fees and charges are set and published each financial year in each council's fees and charges document.

3.3.2 Operational Monitoring

Inspections Program

Existing OWMSs should be inspected to check their compliance with the performance standards set out in the LG Regulation and any relevant conditions of the Approval to Install/ Construct or Alter issued for that OWMS. An existing OWMS does not need to meet any revised standards that have been brought into force since it was installed, provided it meets the above standards.

The inspections program should be guided by the risk rating of the OWMS, which will set out the timing of council inspections, prior to the renewal date of the ATO. An example of an inspection program flow chart is included at Appendix 8. An example operational inspection checklist and equipment list is included in Appendix 7.

Where a system is deemed to not be satisfactory during an operational or investigation inspection, the council's individual compliance and enforcement policies and procedures should be followed.

Each part of the inspection should consider if the system complies with the performance standards. For example, a septic tank should be sealed to prevent ingress of water, soil, insects and vermin. This will reduce the risk of spreading foul odours, the risk of contaminating water through the tank overflowing and discourage insects and vermin.

Complaints

Where a complaint is received about the operation of an OWMS, the council will address the complaint in accordance with their complaint handling policy and an additional inspection may be completed as part of the investigation, if the council deems it necessary.

Servicing Reports

Where an OWMS is required to be serviced due to the conditions of its certificate of accreditation or conditions of approval for installation or modification issued by the council, suitable evidence of servicing is required to be provided to the council. Servicing of accredited systems should be completed by a suitably trained and qualified service agent (Training requirements are outlined in NSW Health Advisory Note 5).

The contract signed between the owner/ occupant and the service agent will generally require that a copy of each service report is provided to the owner/ occupant as well as the council within 14 days of a service.

It is the owner's responsibility to ensure this service report is received by the council and that the service and any repairs are completed. Councils are to maintain a record of service reports.

As the receipt of the service report is a condition of the operation of the OWMS, the council is able to take further regulatory action against the owner if the reports are not received.

Regulatory Tools

Statutory and non-statutory regulatory tools can be most effective when they are used to best repair environmental damage and reduce incidences of re-offending. The most effective regulatory tool is the approach that gets compliance and reduces the incidences of re-offending, which depends on the issue, the offender and context. Use of regulatory discretion and alternative options can sometimes provide the best outcomes with the least amount of conflict.

Non-statutory tools include education, advisory letters and formal warnings. These encourage voluntary compliance and are for less serious non-compliance.

Statutory tools include notices, orders, penalty notices and prosecutions, among other tools. These are used to address environmental harm at varying levels and for repeat offenders.

There are strict requirements to be followed when using statutory tools, or the action can be disputed and be declared as void and could potentially result in a cost to the council.

Powers of Entry

When completing inspections for new installations or modifications, operational inspections for approval to operate applications or investigations due to complaints, the council officer's entry onto the premises needs to be guided by the appropriate procedures. This can be by asking the occupiers permission, or using statutory powers of entry under the LG Act or POEO Act. There are restrictions on entry to residential premises. It is recommended that legal advice is sought in these situations.

Any entry to premises should be conducted in such a way that the council's relevant workplace health and safety policies and procedures are followed and appropriate personal protective equipment is used. Council staff and other people should not be endangered in the course of council inspections.

Notices and Orders

Notices and orders are common strategic tools for regulation of incidents of alleged non-compliance and environmental harm. The correct regulatory tool needs to be selected for each incident. Notices under the POEO Act include:

- Clean-up notice (useful for emergency pollution incidents);
- Prevention notice (issued to ensure an activity is not carried out in an unsatisfactory manner or is carried out in the future in an environmentally satisfactory manner);
- Compliance cost notice (allows the ARA to recover reasonable costs and expenses associated with monitoring compliance of an issued clean up or prevention notice, taking action if the notice isn't complied with and voluntary clean-up action taken by public authorities (councils) under section 92 of the POEO Act).

Orders can be issued under s. 124 of the LG Act to a person to do or refrain from doing a specified activity. For example, this can include non-compliance with an approval or not keeping a premises in a safe or healthy condition.

Education

To improve the performance of OWMSs and compliance with operational inspections, it is recommended that the council provides easily accessible education material to OWM stakeholders, including owners, occupants, site managers and developers. This material can be sourced from the Easy Septic Guide (DLG 2000) found on the OLG webpage, other councils or outside organisations, such as the WaterNSW Designing and Installing On-Site Wastewater Systems (2023a).

Council staff should be provided relevant training in OWM and compliance and enforcement to assist them in their roles assessing applications, inspecting OWMs and completing relevant compliance and enforcement activities.

Draft

Section 4: Site and Soil Evaluation

Site and Soil Evaluation (SSE) is the key to sound OWMS selection, location and sizing. SSE is required as part of all OWMS designs

- Introduction
- Desktop Study
- Site and Soil Evaluation
- Requirements for Tiny Houses

Section 4. Site and Soil Evaluation

4.1 Introduction

Site and Soil Evaluation (SSE) is the key to sound OWMS selection, location and sizing. SSE is required as part of **all** OWMS designs.

The extent and depth of SSE may vary according to the size and complexity of the treatment and effluent application systems required, the level of risk and the stage in the development process.

Consideration should be given to OWM requirements at all stages of the planning and development process. Consideration of OWM requirements at an early stage in the planning process is likely to reduce constraints which pose challenges later in the development process, for example, if lot sizes are sufficiently large at subdivision stage, it is less likely that insufficient space will be available for OWMSs at construction stage.

Consideration of factors such as landform, soils and climate are all part of good SSE. Each of these factors is important in determining:

- The suitability of land for an OWMS;
- The best location for an OWMS; and
- The appropriate size for an OWMS.

This section outlines a best-practice approach to SSE and provides guidance for Site and Soil Assessors in what to deliver, and Regulators in what to require.

When is site and soil evaluation required?

SSE is required for all unsewered developments where effluent is to be wholly or partially managed onsite

The purpose of site and soil evaluation

Site and soil evaluation gathers and interprets the information to support the process of selecting, designing, sizing and locating sustainable OWMSs which protect public and environmental health and optimise beneficial reuse and assimilation of the effluent and its constituents.

On a broad scale, SSE may be undertaken to assess the capacity of a catchment to sustainably manage effluent, to determine sustainable lot sizes and OWMS density. On an individual lot scale, SSE is undertaken to assess the capacity of a lot to sustainably manage effluent within the property boundaries. The WaterNSW Water Sensitive Design Guide for Rural Residential Subdivisions (2023b) may be referred to as a guide where rural residential subdivision design and assessment is required in drinking water catchments.

Who should undertake the site and soil evaluation?

The responsibility for engaging a suitably qualified and experienced professional to undertake a SSE lies with the landowner or developer.

The requirements for SSE are outlined in this document and are defined by council. It is important that the SSE be undertaken by suitably qualified and experienced professionals, with appropriate training in the relevant fields, to meet the requirements of council.

SSE calls on a range of professional skills from a number of disciplines. The site and soil assessor should generally possess:

- a tertiary-level qualification in a discipline such as soil science, geoscience, agricultural science, environmental science or environmental engineering, with specific knowledge and practical experience in soil science, in particular soil hydrological and chemical processes; technical expertise and experience with the broader inter-disciplinary field of OWM, including skills in:
 - the interpretation of site, soil and climatic conditions,
 - undertaking water and nutrient balances and
 - the selection and design of appropriate wastewater treatment and effluent application systems.
- current professional indemnity insurance to cover their work in this field. Landowners, developers and councils should confirm that this insurance is in place before engaging the services of a site and soil assessor.

It is equally important that council officers charged with assessing SSE or OWM reports are trained in these fields and have similar skills.

Rationale

Site and soil evaluation should follow a systematic approach to the collection, recording and interpretation of information on a suitable scale and depth for the purposes of the investigation. All SSEs logically proceed through the following stages: desktop investigation, preparation of site plans, field investigation, interpretation, risk assessment, design and reporting. Broad scale investigations will logically precede and may identify data gaps to be filled by individual lot investigations. Similarly, desktop investigations will identify data gaps which may be filled by field investigation.

Level of investigation

Site and soil evaluation is applicable to all scales of development and stages of development planning. Suitable levels of assessment at each step of the planning process are outlined in Table 1-1 in Section 1.

The level and extent of SSE will depend on a number of factors, such as:

- The stage of the planning process - rural residential release strategy, LEP, DCP, DA for subdivision, DA for single lot development, etc.;
- Data available from previous studies and plans (DCPs, LEPs) or EISs;
- Data and information available from mapped and published sources including soils and soil landscape mapping, eSPADE, Bureau of Meteorology, Government agency and council GIS, etc.;
- The size and density of the proposed development and its potential for wastewater generation;
- The risk of adverse environmental and public health impacts and the presence and vulnerability of environmentally sensitive receptors; and
- Past and present performance of local OWMS.

Each SSE should comprise both desktop analysis to collate and consider relevant published information and detailed site evaluation of individual lots to fill data gaps and enable informed and appropriate system selection, location and sizing.

Typically, evaluation proceeds from a broad evaluation and desktop analysis to more detailed fieldwork. SSE is a key part of each individual lot OWMS design.

Data should be gathered at an appropriate scale for the level of investigation.

4.2 Desktop Study

The desktop study should collate previously mapped information. Much of this will be available in digital form from a range of Government agencies and councils. Digital data can be readily collated in GIS. Mapped data should be acquired to clearly identify the location and extent of the site under consideration and to show a range of biogeographical and anthropogenic information relevant to OWM. In particular, this information should highlight constraints and opportunities which should be considered in system selection, design, sizing and location.

Information that should be gathered, where available, includes but is not limited to:

- Cadastral and planning mapping showing property boundaries, roads, land zoning, and planning specifications;
- Topographic mapping, showing contours and position of surface water bodies;
- Aerial photography;
- Geological mapping and data;
- Soil mapping, soil landscapes and soil test data;
- Mapping of groundwater resources, including domestic and public supply bores including irrigation and livestock supply bores;
- Land use mapping showing current or previous land use, such as agriculture;
- Environmental constraints, such as flooding, bushfire, protected habitats and Water Supply Catchments;
- Location of services such as water, sewer, gas, electricity and stormwater;
- Plans or strategies relating to OWM in the area; and
- Climate data (rainfall and evaporation).

Collation of this data should enable a map to be drawn up which clearly shows the site location, property boundaries and the location of the site with respect to major surrounding development. The site should be located by street address, Lot and DP. In addition, the map should, where possible, show biogeographic constraints, rock outcrops, soil landscape, slope (contours), surface water bodies, location of bores, location of stormwater infrastructure, areas of poor drainage, sensitive vegetation and other environmental constraints. To this can be added the location of existing and proposed structures, other developments or improvements such as driveways and the necessary buffers to buildings, property boundaries and sensitive receptors. The map should clearly and accurately show the scale.

The following sources of information may be of assistance:

- Google Earth: satellite imagery, location (latitude/ longitude/ co-ordinates), elevation, measurement, historical images.
- SIX Maps: cadastral and topographic information, satellite data and aerial photography.
- Nearmap: aerial images, base maps, overlays, location (latitude/longitude/co-ordinates), elevation, measurement, historical images.
- ELVIS: elevation, Digital Elevation Models (DEM).
- Geoscience Australia: geological maps, digital elevation data.

- eSPADE: soil landscapes, soil mapping, soil data, soil reports.
- ePlanning: zoning maps, hazard maps, protection maps.
- Flood data portal: flood mapping, flood data, flood studies.
- BOM Groundwater Explorer: bore locations, bore logs, groundwater depth data.
- Hydrogeological maps.
- WaterNSW: real time water monitoring data.
- WaterNSW reference and advisory material
- SEED: acid sulfate soils, wetlands, priority aquaculture areas, endangered ecological communities.
- Before You Dig Australia (BYDA): water, sewer, gas, telecommunications and electricity services.
- BOM: climate data, rainfall, evaporation.
- The relevant council's mapping, planning and studies, including flood, bushfire, and vegetation mapping and studies and LEP zoning. Some of this data is available online, while other data may require an enquiry to be lodged with the council.

These resources will help identify a range of site parameters and determine constraints and opportunities for OWM which can be brought together in a preliminary constraints map.

Where data gaps are identified, these should be noted for further investigation.

Desktop study is appropriate as the first stage of:

- Broad scale investigations for land release;
- Assessment for subdivision; and
- Individual lot design

4.2.1 Broad Scale Investigation for Land Release

Broad scale evaluation may be undertaken as part of a rural residential land release investigation. It should collate relevant information to facilitate the review and consideration of constraints and opportunities relating to the management of wastewater in relation to the proposed development. It should have a prime focus on ensuring that individual subdivided lots are sufficiently large enough to accommodate sustainable OWMSs appropriate for the likely future development.

Wastewater management considerations should be included in the development of rural residential land release strategies and LEPs. Land, soil and climatic information should be assessed to determine the broad constraints and compatibilities for OWM over a selected area. One or more local councils would normally undertake the evaluation over the nominated area and report the results as part of a rural residential land release strategy.

The aim of the study is to make a preliminary classification of the land into those areas with minor, moderate or major limitations to OWM, and to undertake a preliminary assessment of the preferred systems to be used. Identifying the constraints as early as possible in the planning process should improve the efficiency of the next steps of the site evaluation, because land with major limitations may be identified as unsuitable for OWM servicing and excluded from further study onsite.

The desktop evaluation should include:

- An assessment of the existing infrastructure, such as reticulated sewerage;
- An assessment of future council plans for the area, including provision of infrastructure;
- An assessment of the performance of any existing OWMSs including classification of areas in which existing OWMSs do not generally address site and soil constraints, where systems are failing, or where systems are or are likely to be, causing adverse public health and environmental impacts;
- A preliminary assessment of the practicality of providing centralised sewerage systems where reticulated water exists or can be supplied;
- An overview of the soil and landscape characteristics (geology, topography, rock outcrops, soils, groundwater, vegetation) across the area, taking into account the degree and location of constraints that could affect the siting, design, sizing, installation and operation of OWMSs;
- A description of the extent and nature of any environmentally sensitive areas and the potential for impacts upon these;
- Median monthly precipitation data and mean monthly evaporation data and its expected variation over the study area;
- Calculation of a water balance over the area using local rainfall and evaporation data (see Appendix 6);
- Collection of information on groundwater vulnerability, the nature of any aquifers, the location of bores, water table heights, and the nature and extent of any groundwater quality and use;
- Mapping of flood risk contours and setbacks from waterways or other sensitive areas;
- An assessment of potential impacts and cumulative impacts over time of establishing OWMSs in the area under investigation, paying particular attention to surface and groundwater contamination and salinity hazard;
- Preliminary classification of the expected available effluent application areas. Areas identified as having major limitations may not need to be assessed further if development cannot proceed without a centralised sewerage system being installed;
- Preliminary identification of suitable OWMSs; and
- Preliminary identification of minimum lot sizes and maximum development densities.

It should be noted that effluent application systems operating mainly by soil absorption, with only limited evapotranspiration, are in some instances predominantly wastewater application systems rather than reuse systems. The potential for contamination of groundwater by nutrients or pathogens may be increased with the use of such systems if contaminant levels have not been sufficiently reduced in the final effluent. It is important that local councils assess and determine the environmentally sustainable density of OWMSs for any given area.

A number of studies (USEPA 1992, Hoxley and Dudding 1994, Rawlinson 1994) have shown that high densities of OWMSs (of the order of 15 systems per square kilometre) can be contributory to adverse nutrient and bacterial impacts on groundwater.

At this stage of evaluation, local councils should assess the potential cumulative impacts of establishing OWMSs in an area, particularly the potential for increase in nutrient concentrations and salinity within the study area catchment. This is crucial in areas where OWMSs are already in use and

further systems are proposed. The level of detail of the investigation will depend on the stage of the planning process. For example, a more detailed picture of the area under consideration and its relationship with its surroundings should be included at the LEP stage; the information may take the form of a Local Environmental Study (LES) or other environmental investigation.

If the broad evaluation desktop assessment shows that OWM is not appropriate in a particular area, development should not proceed unless more suitable management options, such as partial or total off-site management, can be provided.

Studies at this stage should guide considerations of minimum sustainable lot size and or maximum lot density, with a view to individual approved lots being of sufficient size for sustainable OWM with no off-lot impacts.

The information gathered at the desktop study stage of a broad scale investigation might need to be clarified further by more detailed mapping or field investigation including SSE, especially as part of an assessment for subdivision or an individual lot design.

4.2.2 Assessment for Subdivision

A desktop study should be the first part of an assessment for subdivision to gather background information on the site, to assess constraints and opportunities, to determine the required extent and level of detail of SSE and to help plan and guide the field investigation.

The desktop study for subdivision assessment might bring forward material gathered as part of an earlier broad scale investigation for land release, if it is available. It is likely that additional and more detailed material will be required at this stage.

In particular, the desktop study should determine the relationship between the soil landscape mapping and the layout of the proposed lots and should ensure that sufficient information is available to determine or confirm that individual lot sizes and configurations are appropriate for OWM.

At this stage, available effluent application areas should be identified on each lot which are adequately sized to allow sustainable OWM within the site and soil constraints of the lots and appropriate buffers to planned improvements and sensitive receptors.

OWM may not be appropriate where individual risk elements represent major constraints. Where individual risk elements or constraints are identified at a major or moderate level, clear and quantifiable risk reduction measures must be identified as part of the design to reduce those risk elements to a minor level. This may include restriction on certain types of OWMS or EAA.

Care should be taken to identify all potential areas for land application and the study should demonstrate any variability in key site and soil characteristics.

Typically, the outcome of a desktop study for assessment of a subdivision will identify the proposed layout of individual lots. Site plans should show variability in soil landscapes across the subdivision and should recommend locations for more detailed soil investigations. The plan should provide recommended locations for soil sampling which will characterise each soil landscape and also the soils on each proposed individual lot. Soil sampling density for this scale of investigation is a minimum of one soil test pit per soil landscape or facet with a minimum of one confirmatory borehole per proposed lot. Should soils show great variability, a higher density of soil sampling is required. Soil pits and bores should be sampled as outlined in the more detailed description provided in Section 4.2.3 on individual lot design.

Soil sampling should be used to modify or confirm the proposed lot layout, and the lot layout only finalised once this level of soil investigation has been completed and the soil data interpreted.

Desktop study and soil sampling at subdivision assessment stage does not remove the need for further detailed SSE at the individual lot design stage.

4.2.3 Individual Lot Design

Desktop study is also an important element of individual lot design. It can help identify data gaps to be filled by SSE, help with shortlisting suitable treatment options which will achieve the desired level of treatment and identify available Effluent Application Areas (EAAs). The constraints map guides the SSE and directs the site and soil assessor to those pieces of information which are still outstanding and are required to complete the design. The constraints map should have target locations for test pits and boreholes identified in advance of the SSE.

4.3 Site and Soil Evaluation

SSE should be completed for each individual lot and as part of each individual OWMS design. Whilst some information may be available from the earlier broad investigation or subdivision assessment stages, additional detailed information will be required to complete the individual lot design. This will include collation and interpretation of data on site and soil characteristics of the individual lot which will enable a suitable and sustainable combination of treatment and effluent application system to be selected, located and sized, appropriate to the proposed development.

The SSE should be completed as one integrated exercise. It is best completed by the same person that has completed any previous desktop study and who will complete the final design and reporting. That way, key information can be most readily transferred from one part of the design process to the next, to maintain the integrity of the design.

Potential locations for OWMSs should be identified based on the features listed in Table 4-1. Areas where sites are limiting or unsuitable for the installation of OWMSs should be indicated on individual site plans and should be avoided.

4.3.1 Site Features

Descriptions of the site features that should be assessed are listed below. For more information on these features, including assessment details, see the Australian Soil and Land Survey Field Handbook 3rd edition (National Committee on Soil and Terrain 2009).

Note that the extent to which some features apply will depend on the treatment and effluent application systems selected. It is important to assess all relevant features.

Table 4-1 lists systems for which each site feature is significant together with a risk rating which outlines the degree of limitation for each site feature. Councils might consider using Table 4-1 to check all relevant site features have been considered in design reports.

Limiting features determine the site capability for an onsite treatment and/ or effluent application system. For all designs, any features which pose a risk by identifying as major or moderate limitations, the designer must present clear risk reduction measures which reduce those risks to no more than minor limitations. These limitations may be overcome by using alternative designs or by modifying the site.

Table 4-1: Site Features - Risk Ratings for OWMSs

Site Feature	Relevant System(s)	Risk Rating			Restrictive Feature
		Minor Limitation	Moderate Limitation	Major Limitation ¹	
Geology/ regolith	All EAA systems			Major geological discontinuities, fractured or highly porous bedrock or regolith	Groundwater pollution hazard
Shallow bedrock	In ground treatment systems and all EAA systems			Bedrock at shallower depth than tanks or effluent application systems	Difficult excavation Low hydraulic conductivity Shallow limiting layer (see Table 4-4)
Rocks and rock outcrops (% of land surface containing rocks (floaters) >0.2m diameter)	All EAA systems	<10%	10-20%	>20%	Limits EAA system performance Provides preferential flow paths Difficult excavation
Fill	All OWMS	No fill	Fill present		Subsidence Variable permeability
Landform	All OWMS	Hill crests, divergent slopes and plains	Convergent slopes and foot slopes	Drainage plains and incised channels	Groundwater pollution hazard Resurfacing hazard
Slope %	Subsurface irrigation	0 - 20	20 - 30	>30	Difficult installation Linear Loading Rate (LLR) Run-off Erosion
	Surface irrigation	0 - 5	5 - 10	>10	Difficult installation LLR Run-off Erosion
	EvapoTranspiration Absorption (ETA)/ Absorption system: trench	0 - 10	10 - 15	>15	Difficult installation LLR Run-off Erosion
	ETA/ Absorption system: bed	0 - 5	5 - 10	>10	Difficult installation LLR Run-off

Site Feature	Relevant System(s)	Risk Rating			Restrictive Feature
		Minor Limitation	Moderate Limitation	Major Limitation ¹	
					Erosion
	Mound	0 - 10	10 - 15	>15	Difficult installation Large volume of sand required. Risk of toe seepage
Erosion potential	All EAA systems	No signs of erosion potential present Well vegetated	Absence of vegetation	Signs of erosion, e.g. rills, mass movement and slope failure present	Soil degradation and Transport System failure
Run-on and upslope seepage	All EAA systems	None	Some - diversion possible	High - diversion not practical	System inundation Transport of effluent off-site
Flood potential	All treatment systems	Vents, openings, and electrical components above 1 in 100-year flood contour		Vents, openings, and electrical components below 1 in 100-year flood contour	Transport of effluent off-site System failure and electrocution hazard
	All EAA systems	Rare; above 1 in 20-year flood contour		Frequent; below 1 in 20-year flood contour	System inundation. Transport of effluent off-site
Site drainage	All effluent application systems	No visible signs of surface dampness		Visible signs of surface dampness, such as moisture-tolerant vegetation (sedges and ferns), seepages, soaks and springs	Groundwater pollution hazard Resurfacing hazard
Exposure	All effluent application systems	High sun and wind exposure		Low sun and wind exposure	Poor evapotranspiration
Land area	All systems	Area is available		Area is not available	Health risk Pollution risk
Buffer distance	All effluent application systems	(see Section 4.3.2 and Table 4-2)			Health risk Pollution risk

NOTES

1. Sites with major limitations are generally **not** suitable for land application of effluent. Risk reduction measures must be applied to reduce to minor limitation.

Geology/ Regolith

EAs should not be installed near major geological discontinuities or fractured or highly porous bedrock or regolith, as these structures can provide short-circuits of effluent to groundwater.

Shallow bedrock

Shallow bedrock can pose problems for excavation for tanks and effluent application systems. Shallow bedrock, less than 0.6 metre beneath the point of application of effluent at the base of an effluent application system will constitute a limiting layer. All effluent application systems require 0.6 metre of free-draining soil beneath the point of application (i.e. above shallow bedrock). The Design Loading Rate (DLR) is based on the lowest hydraulic conductivity soil horizon within 0.6 metre beneath the point of application.

Rocks and Rock Outcrops

The presence of rock outcrops usually indicates bedrock at shallow depth. Rock outcrops or large rocks (floaters) may make excavation for tanks and effluent application systems difficult. Large rocks can give rise to preferential pathways (short-circuits) which can interfere with drainage and increase the risk of surface breakout of effluent or groundwater contamination.

Fill

Fill is soil or soil like material resulting from human activities that has led to modification or burial of the original soil or the creation of new soil parent material. Fill often has highly variable properties, in particular permeability. Fill can be prone to subsidence or uneven compaction and may contain material that makes excavation difficult or inhibits plant growth. Fill can be removed, but if this is not possible, a detailed assessment of in-situ fill will be required. Equally, good quality soil may be imported to elevate or enhance the performance of an effluent application system. This can sometimes be acquired from other areas of the site where excavation has taken place for construction of buildings, driveways etc., as long as the material is of equivalent texture and not contaminated.

Slope

Excessive slope might pose problems for installing systems, increase downslope drainage which might result in saturation, surface breakout and run-off from EAs and create difficulties in even distribution of the effluent. The recommended maximum slope will vary depending on the type of effluent application system selected and the site and soil characteristics. The values given in Table 4-1 are based on ideal site and soil conditions. If the conditions are less than ideal, the maximum acceptable slopes should be reduced.

Where possible, slopes that have potential for mass movement or slope failure should be avoided. If construction of an OWMS on a potentially unstable slope cannot be avoided, professional geotechnical advice should be obtained and design and installation should follow Australian Geoguide LR9 (Effluent Application) (Australian Geomechanics Society 2007).

Erosion Potential

OWMSs should not be installed on land that shows evidence of or is likely to be affected by erosion. Vegetation should be established and maintained to enhance evapotranspiration and minimise erosion risk. Sites showing evidence of erosion should have this taken into account in the design and have suitable erosion and sediment controls installed during construction and maintained until vegetation is re-established. See Section 6.9.3.

Run-on and Upslope Seepage

Run-on of surface water flow from up-gradient areas onto the EAA should be avoided. Run-on water should be diverted around any EAA by means of a diversion berm and/or a groundwater cut-off trench

which discharges downslope of the effluent application system. Care should be taken to ensure that discharge of diverted run-on water does not cause erosion or other adverse impacts.

It is important that effluent application systems for OWM are not impacted by, nor impact upon stormwater management systems, including stormwater quality improvement devices. In particular, care should be taken to ensure that upslope stormwater management systems do not add to the hydraulic load managed by the EAA. See Section 6.9.2.

Flood Potential

All electrical and control components of OWMs should be located above the 1 in 100-year flood level. Where possible, treatment systems should be located above the 1 in 100-year flood level. Treatment systems located in flood prone areas should be sealed to prevent flood water ingress. EAAs should be located above the 1 in 20-year flood level. EAAs located in flood prone areas should be pressure dosed rather than gravity fed. In flood prone areas, consideration should be given to raising effluent application systems above the likely flood level.

Site Drainage

OWMs should not be installed on poorly drained sites. Vegetation, including sedges and ferns, may indicate poor drainage and surface dampness. Seepage, springs, soaks and soil mottling are also indicators of poor site drainage. Site drainage can best be determined by inspecting both the soil and vegetation.

Exposure

EAAs should be located where exposure to sun and wind can be maximised to enhance evaporation and transpiration. Factors affecting exposure include the geographical aspect of the area and the shading capacity of tall vegetation and buildings near the proposed EAA. Evaporation can be reduced significantly in some locations by a poor aspect or overshadowing and sheltering by topography, buildings, solid fences or vegetation.

Land Area

Sufficient and appropriate land must be available within the boundaries of the site for the following (where appropriate):

- Wastewater management system, including the treatment system and dedicated effluent application system;
- EAA and reserve area (primary treatment systems only);
- Buffers to improvements and sensitive receptors;
- Dwelling, associated structures and improvements;
- Social and recreational facilities; and
- Vehicular access areas.

4.3.2 Buffer Distances

To ensure protection of public and environmental health and amenity, buffers should be maintained between OWMs and sensitive receptors both on and off the site.

A risk-based approach to buffer distances should consider the level of constraint imposed by a range of relevant site and system features to determine appropriate buffer distances to sensitive receptors. The overall buffer distance should be commensurate with the level of risk to public and environmental health. See Table 4-3 for a list of constraint scale ranges.

Buffers must be set to suit local conditions and must be set in consultation with water authorities for drinking water extraction areas (surface or groundwater) and the NSW Food Authority in Priority Oyster Aquaculture Areas. These areas may be located outside the council boundary. In this case consultation with adjacent authorities would be necessary.

Consideration should be given to the level of treatment of wastewater or greywater in determining the associated risk.

Buffers should be at the upper end of the prescribed range for any surface application of effluent.

Suitable buffer distances can typically be determined or confirmed by modelling methods such as nutrient attenuation modelling and viral die-off modelling. It is recommended that prescribed buffers be set conservatively for the range of sensitive receptors and that reductions should only be allowed if modelling can clearly show that the prescribed buffers are unnecessarily conservative. Appropriate buffer distances to sensitive receptors are shown in Table 4-2 below.

Table 4-2: Appropriate Buffer Ranges for Sensitive Receptors

Sensitive receptor	Buffer range (m)
Horizontal separation	
Property boundaries ¹	1.5 – 15.0
Buildings	2.0 – 6.0
Retaining walls, embankments and cuttings	3.0 or 45° angle from toe of wall (whichever is the greater)
Drives, paths and walkways	1.5 – 6.0
Swimming pools, recreational areas, market gardens	3.0 – 15.0
In-ground water tanks and services (water, electrical, telecommunications and plumbing)	3.0 – 15.0
Permanent surface water bodies ²	50.0 – 100.0
Intermittent water bodies, farm dams, roadside drainage, drainage depressions, stormwater systems ²	15.0 – 40.0
Bores and wells ^{2,3}	15.0 – 100.0
Vertical separation⁴	
Groundwater	0.6 – 1.5

Sensitive receptor	Buffer range (m)
Bedrock and hardpans	0.6 – 1.5

NOTES:

1. Buffers for subsurface drip irrigation of secondary treated effluent downslope of an upslope property boundary, may be reduced to 0.5 metre.
2. In drinking water extraction areas and oyster aquaculture areas, buffers should be set in consultation with Water Authorities and NSW Food Authority. Examples can be found in the 'Designing and Installing On-site Wastewater Management Systems (WaterNSW 2023a) and NSW Oyster Industry Sustainable Aquaculture Strategy (DPI 2021a).
3. This includes bores and wells with water used for potable use (e.g. within a dwelling). Reduced buffers must be justified by viral die-off modelling. In groundwater extraction areas for a potable supply, buffers should be set in consultation with Water Authorities.
4. Vertical separation from the point of effluent application at the base of the effluent application system to the highest seasonal water table as evidenced by soil mottling, or other limiting layer. Where the separation distance is less than 0.6 metre the point of application should be raised by importation of soil or sand to create a raised bed or mound.

Site and system constraints and scale descriptors are outlined below in Table 4-3. The buffer for a particular site feature or sensitive receptor should be selected from the buffer distance range according to a risk assessment which considers where each of the relevant site and system constraints lie on the respective constraint scale.

Justification of the selected buffer should be based, where possible, on quantitative evaluation of the relevant site or system features.

Table 4-3: Constraint Scale Ranges

Buffer distance range	Relevant site and system constraints	Constraint scale	
		Low	High
Property Boundaries			
1.5m – 15.0m	Effluent quality	Secondary treated effluent (with disinfection and contractual service agreement)	Primary treated effluent
	Slope	0-6% (surface effluent application), 0 -10% (subsurface effluent application)	>10% (surface effluent application), >30% (subsurface effluent application)
	Method of application	Subsurface or subsoil application	Surface/ above ground application
Buildings			
2.0m – 6.0m	Effluent quality	Secondary treated effluent (with disinfection and contractual service agreement)	Primary treated effluent
	Slope	0-6% (surface effluent application), 0 -10% (subsurface effluent application)	>10% (surface effluent application), >30% (subsurface effluent application)

Buffer distance range	Relevant site and system constraints	Constraint scale	
		Low	High
	Method of application	Subsurface or subsoil application	Surface/ above ground application
Retaining Wall/ Embankment Cutting			
Greatest of 3.0m or 45° angle from toe of wall	Slope	0-6% (surface effluent application), 0 -10% (subsurface effluent application)	>10% (surface effluent application), >30% (subsurface effluent application)
	Flood potential	Above 1 in 20-year flood contour	Below 1 in 20-year flood contour
	Geology/ Soil	Category 3 and 4 soils, low porosity regolith, deep, uniform soils	Category 1 and 6 soils, fractured rock, gravel aquifers, high porosity regolith
Path/ Walkway			
1.5m – 6.0m	Effluent Quality	Secondary treated effluent (with disinfection and contractual service agreement)	Primary treated effluent
	Fall direction	Downgradient of surface water body, property boundary, recreational area	Upgradient of surface water body, property boundary, recreational area
	Method of Application	Subsurface or subsoil application	Surface/ above ground application
Swimming Pool/ Recreational Area			
3.0m – 15.0m	Effluent Quality	Secondary treated effluent (with disinfection and contractual service agreement)	Primary treated effluent
	Fall direction	Downgradient of surface water body, property boundary, recreational area	Upgradient of surface water body, property boundary, recreational area
	Method of Application	Subsurface or subsoil application	Surface/ above ground application
In-ground water tanks and services (water, electrical, telecommunications and plumbing)			
3.0m – 15.0m	Effluent Quality	Secondary treated effluent (with disinfection and contractual service agreement)	Primary treated effluent
	Fall direction	Downgradient of surface water body, property boundary, recreational area	Upgradient of surface water body, property boundary, recreational area
Permanent Surface Water Body			
50.0m – 100.0m	Effluent Quality	Secondary treated effluent (with	Primary treated effluent

Buffer distance range	Relevant site and system constraints	Constraint scale	
		Low	High
		disinfection and contractual service agreement)	
	Surface water pollution hazard	Category 1 to 3 soils no surface water down gradient within 100m; low rainfall area	Category 4 to 6 soils permanent surface water <50m down gradient; high rainfall; high resource/ environmental value
	Slope	0-6% (surface effluent application), 0 -10% (subsurface effluent application)	>10% (surface effluent application), >30% (subsurface effluent application)
	Fall direction	Downgradient of surface water body, property boundary, recreational area	Upgradient of surface water body, property boundary, recreational area
	Drainage	No visible signs of saturation	Visible seepage; moisture tolerant vegetation; low lying area
	Flood Potential	Above 1 in 20-year flood contour	Below 1 in 20-year flood contour
	Application Method	Subsurface or subsoil application	Surface/ above ground application
Intermittent water bodies, farm dams, roadside drainage, drainage depressions			
15.0m – 40.0m	Effluent Quality	Secondary treated effluent (with disinfection and contractual service agreement)	Primary treated effluent
	Surface water pollution hazard	Category 1 to 3 soils no surface water down gradient within 40m; low rainfall area	Category 4 to 6 soils intermittent surface water <20m down gradient; high rainfall; high resource/environmental value
	Slope	0-6% (surface effluent application), 0 -10% (subsurface effluent application)	>10% (surface effluent application), >30% (subsurface effluent application)
	Fall direction	Downgradient of surface water body, property boundary, recreational area	Upgradient of surface water body, property boundary, recreational area
	Drainage	No visible signs of saturation	Visible seepage; moisture tolerant vegetation; low lying area
	Flood Potential	Above 1 in 20-year flood contour	Below 1 in 20-year flood contour
	Method of Application	Subsurface or subsoil application	Surface/ above ground application

Buffer distance range	Relevant site and system constraints	Constraint scale	
		Low	High
Bore/ Well			
15.0m – 100.0m	Effluent Quality	Secondary treated effluent (with disinfection and contractual service agreement)	Primary treated effluent
	Groundwater pollution hazard	Category 5 and 6 soils, low resource/ environmental value	Category 1 and 2 soils, gravel aquifers, high resource/ environmental value
	Geology / Soil	Category 3 and 4 soils, low porosity regolith, deep, uniform soils	Category 1 and 6 soils, fractured rock, gravel aquifers, high porosity regolith
Groundwater			
0.6m – 1.5m	Effluent Quality	Secondary treated effluent (with disinfection and contractual service agreement)	Primary treated effluent
	Groundwater pollution hazard	Category 5 and 6 soils, low resource/ environmental value	Category 1 and 2 soils, gravel aquifers, high resource/ environmental value
	Drainage	No visible signs of saturation	Visible seepage; moisture tolerant vegetation; low lying area
	Geology/ Soil	Category 3 and 4 soils, low porosity regolith, deep, uniform soils	Category 1 and 6 soils, fractured rock, gravel aquifers, high porosity regolith
	Landform	Hill crests, convex side slopes, and plains	Drainage plains and incised channels
	Method of Application	Subsurface or subsoil application	Surface/ above ground application
Bedrock/ Hardpan			
0.6m – 1.5m	Effluent Quality	Secondary treated effluent (with disinfection and contractual service agreement)	Primary treated effluent
	Groundwater pollution hazard	Category 5 and 6 soils, low resource/ environmental value	Category 1 and 2 soils, gravel aquifers, high resource/ environmental value
	Method of Application	Subsurface or subsoil application	Surface/ above ground application

When determining buffer distances, consideration should also be given to:

- The type of effluent application system to be used;
- Surface and subsurface drainage pathways and adjusted flow paths;

- Site factors - soil permeability, geology, vegetation buffering;
- Sensitive environments - drinking water catchments, national parks, rainforests, estuaries, oyster aquaculture leases, wetlands, groundwater, vegetation;
- Groundwater extraction areas, and areas with poor tidal flushing;
- Existing development including EAA, buildings, driveways;
- Surrounding land uses, including food production; and
- Development density.

Drinking Water Sources

Councils, designers, water utilities and private drinking water suppliers should be aware of local sources of drinking water (surface, groundwater, tank storage) and consider the implications of an OWMS on any risk management plan required under the Public Health Act 2010. Where an OWMS is present within 250m, limitations will be placed on applications for new groundwater bores.

Treatment system location

The location of the treatment system components should consider the structural integrity of existing and proposed buildings and structures during installation and following. It should also consider impacts on the occupants of dwellings on the site and adjacent sites in terms of offensive odours and noise impacts. These risks can be mitigated using setbacks based on structural assessment, and noise and odour minimisation techniques. Generally, treatment systems are located downslope of buildings where wastewater is generated.

Climate

Climate influences the assimilation of the hydraulic load of effluent for all types of effluent application systems. Effluent application systems work best where there is high evaporation relative to precipitation, resulting in greater uptake of the hydraulic load.

Surface irrigation designs are inappropriate in areas where rainfall exceeds evaporation for extensive periods of time and soils may be saturated. Where a water balance shows that the inputs of rainfall and effluent exceed the outputs of evapotranspiration and seepage, in-ground storage may temporarily accommodate excess hydraulic load. In such cases, a best practice approach to effluent management is to treat to secondary standard, disinfect and discharge under pressure to a subsurface effluent application system to maximise in-ground storage. This approach will minimise risk of adverse impacts to groundwater and surface water quality and hence reduce the likelihood of adverse environmental and public health outcomes.

A water balance based on appropriate historical median rainfall and mean evaporation data for the locality should be completed and used to determine the size of effluent application systems. The water balance concept is explained in Section 6.3.3 and Appendix 6.

Lower daytime temperatures such as those experienced in higher altitude areas may inhibit the performance of wastewater treatment processes which rely on biological activity e.g. AWTS and composting toilets. Freezing temperatures may impact surface or shallow subsurface components of OWMS.

4.3.3 Soil Assessment Terminology

Soil Assessment – Basic Terminology Summary

Ground surface – The upper surface of the natural or imported soil in an effluent application system.

Point of Application – The point at which effluent is applied to the soil. This is the level of the emitters in an irrigation system or the base of a bed or trench system.

Limiting layer – The layer of soil with the lowest hydraulic conductivity (permeability) or any other low hydraulic conductivity layer such as a hard pan or bedrock, or the water table, or seasonal high water table (as evidenced by soil mottling), within 0.6 metre beneath the point of application (see Figure 4-1). The design loading rate is based on the hydraulic conductivity of the limiting layer.

Free-draining soil – Soil, beneath the point of application and above any limiting layer, through which effluent can pass freely under gravity. There must be a minimum of 0.6 metre of free-draining soil beneath the point of application in any effluent application system.

Separation distance – The separation between the point of application and a limiting layer. The separation distance between the point of application and the limiting layer should be a minimum of 0.6 metre.

Following initial treatment of wastewater in the treatment system, OWMs rely on further treatment of effluent in the effluent application system and underlying soil.

The main purpose of soil assessment is to accurately determine soil depth and soil characteristics in the available EAAs to ensure that there is a minimum of 0.6 metre of free-draining soil beneath the point of application of effluent at the base of the effluent application system and to assign an appropriate hydraulic loading rate which reflects the level of treatment, the type of effluent application system and the soil textural class. Figure 4-1 shows the point of application for various effluent application systems.

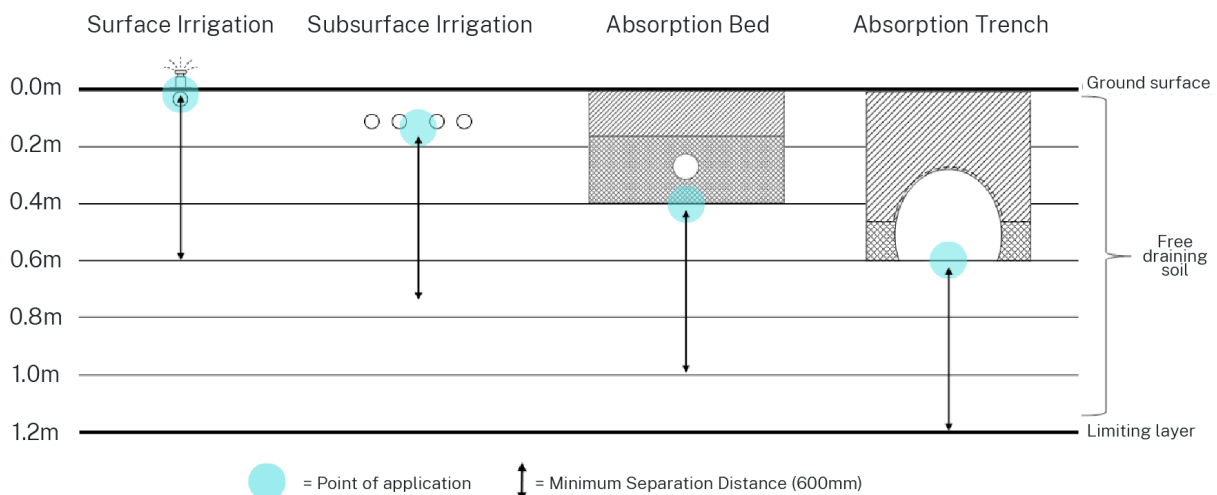

Figure 4-1: Point of Application in EAA Systems and Minimum Separation Depths

It is important that the investigation adequately characterises the soil in the proposed EAA. A minimum of one test pit and two confirmatory boreholes should be dug in the available areas, one near the centre of the area and one at each of the near and far ends. If the soil shows significant variation, more test pits or boreholes should be dug to determine the variability and confirm that the soil information acquired is adequate for the design. In all cases, the soil test pits or boreholes should be dug to a minimum of 1.0 metre in depth or 0.6 metre beneath the proposed point of application, whichever is the greater. The DLR is determined on the basis of the textural class of the soil which has the lowest hydraulic conductivity (permeability) within the zone of influence, 0.6 metre beneath the point of application.

Figure 4-2 shows the appropriate levels of soil investigation for different effluent application systems.

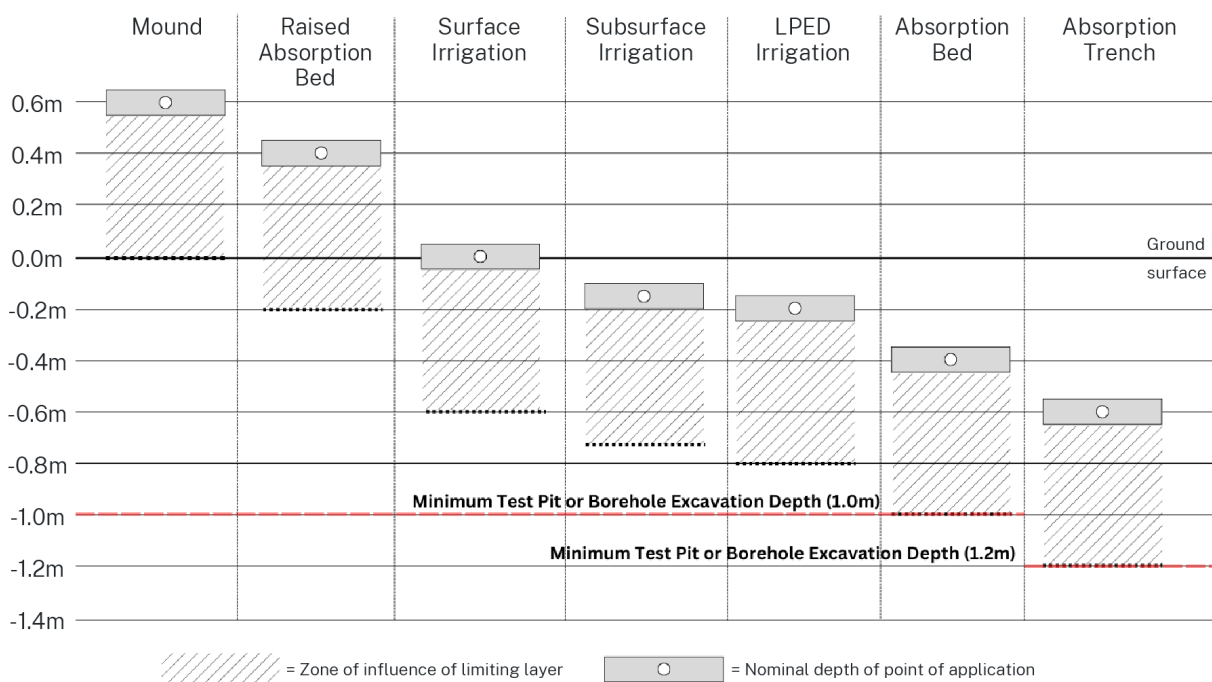

Figure 4-2: Appropriate Levels of Soil Investigation for Different EAA Systems

The soil investigation should also identify the presence and depth of any other limiting layer, such as a hard pan, bedrock or the water table. An intermittent or seasonal high water table is identified by soil mottling which indicates that, at least for part of the time, soil at that level is saturated and hence would not be free-draining.

4.3.4 Soil Features

Soil is a complex mixture of mineral and organic particles that vary widely, both horizontally and vertically and with time. Having an understanding of the soil at a site is critical in selecting, locating and sizing an appropriate OWS that will perform to the expectations set out in the performance standards of these Guidelines.

While the broad evaluation/ desktop study will provide preliminary information on soil characteristics, a detailed soil evaluation is required for accurate assessment. Councils should stipulate requirements for the soil evaluation in their OWS strategy or DCP. Councils might consider using Table 4-5 to check all relevant soil features have been considered in design reports.

Soil assessments involve observation, measurement, recording and interpretation of soil attributes within the soil profile. A soil profile is a vertical section of soil consisting of various soil horizons. A soil

horizon is a layer of soil that has distinct physical, chemical and biological properties which differ from the layers above and below. Soil characteristics should be assessed by sampling from each horizon of at least one test pit and two confirmatory test pits or boreholes within the proposed EAA. The coordinates of each test pit or borehole location should be recorded and the location marked accurately on the site plan.

Make profile description pits large enough for the soil profile to be viewed, identified and photographed to the required depth. Photographs of each soil test pit and borehole, together with the excavated soil, laid out to show the soil profile at each location, should be taken for inclusion in the wastewater report.

Soils from each test pit or borehole should be logged with soil horizon depths recorded along with major features and limiting characteristics, such as water tables, seasonal high water table (as shown by soil mottling), hard pans or bedrock.

Soil samples from each horizon in each test pit or borehole should be collected for analysis and testing. Some tests may be conducted in the field, whilst others are best undertaken in the laboratory. Samples should be individually bagged and labelled with information including the test pit or borehole number and sample depth recorded to ensure that soil data can later be attributed correctly to individual test pits and boreholes.

Samples should be analysed for relevant parameters set out in Table 4-4 unless otherwise specified in Table 4-5. Information from soil cores or pits and laboratory data should be described using the conventions outlined in the eSPADE user manual, which can be found on the NSW Environment and Heritage website.

The soil features that should be assessed are listed below. More information on these features (including assessment and analysis requirements) can be found in the following texts:

- Australian Soil and Land Survey Field Handbook 3rd edition (National Committee on Soil and Terrain 2009); and
- Soil Chemical Methods – Australasia (Rayment and Lyons 2010)

The features of the most limiting horizon are used to determine the site capability and soil loading rate for an effluent application system for onsite wastewater management. In some cases, the problems posed by a limiting feature or features can be overcome by incorporating modifications to the site and/ or soil into the design.

Table 4-4: Soil Features - Risk Ratings for OWMSSs

Soil Feature	Relevant System	Risk Rating			Restrictive Feature
		Minor Limitation	Moderate Limitation	Major Limitation ¹	
Depth to bedrock or hardpan (m)	Subsurface irrigation	>1.0	0.75 - 1.0	<0.75	Possible waterlogging Increased risk of runoff May limit plant growth (trees)
	Surface irrigation	>1.0	0.6 - 1.0	<0.6	Possible waterlogging Increased risk of runoff May limit plant growth (trees)
	Absorption system	>1.5	1.2 - 1.5	<1.2	May restrict seepage Resurfacing hazard Groundwater pollution hazard
Depth to high episodic/seasonal water table (as evidenced by mottling) (m)	Subsurface irrigation	>1.0	0.75 - 1.0	<0.75	Resurfacing hazard Groundwater pollution hazard
	Surface irrigation	>1.0	0.6 - 1.0	<0.6	Resurfacing hazard Groundwater pollution hazard
	Absorption system	>1.5	1.2 - 1.5 ²	<1.2	May restrict seepage Groundwater pollution hazard
Soil permeability Category ³	Subsurface irrigation Surface irrigation	2b, 3 and 4	1, 2a, 5 and 6		Excessive run-off, waterlogging Percolation
	LPED	2, 3 and 4	5	1 and 6	
	Evapotranspiration Absorption system	4 and 5	6 ⁴	1, 2 and 3	

Soil Feature	Relevant System	Risk Rating			Restrictive Feature
		Minor Limitation	Moderate Limitation	Major Limitation ¹	
	Absorption system	3 and 4		1, 2, 5, and 6	
Coarse fragments (%)	All land application systems	<20	20 - 40	>40	Preferential flow pathways through soil May restrict plant growth May impede installation
Bulk density (g/cm ³)	All EAA systems Sandy loam Clay loam Clay	<1.8 <1.6 <1.4		>1.8 >1.6 >1.4	Indicator of permeability May restrict plant growth
pH ⁵	All EAA systems	>6.0	4.5 - 6.0	<4.5	May inhibit plant growth
Electrical conductivity (dS/m)	All EAA systems	<4	4-8	>8	Excessive salt may restrict plant growth
Sodicity (exchangeable sodium percentage) ⁵	Subsurface irrigation Surface irrigation (0-0.4 m)	<5	5-10	>10	Potential for structural degradation
	Absorption system (0-1.2m)				
Cation exchange capacity (cmol ⁺ /kg) (0-40cm) ^{5, 6}	Subsurface irrigation Surface irrigation	>15	5-15	<5	Indicator of soil fertility Unable to hold plant nutrients

Soil Feature	Relevant System	Risk Rating			Restrictive Feature
		Minor Limitation	Moderate Limitation	Major Limitation ¹	
Phosphorus sorption (kg/ha)	All EAA systems (0-100cm for irrigation) 100cm below intended base of trench)	>6,000 (approximately 375 mg/kg)	2,000-6,000	<2,000 (approximately 125 mg/kg)	Unable to immobilise any excess P
Modified Emerson Aggregate Test (dispersion class) ⁵	All EAA systems	Class 3, 4, 7, 8	Class 2	Class 1	Potential for structural degradation

NOTES:

1. Sites with major limitations are generally **not** suitable for land application of effluent. Risk reduction measures must be applied to reduce to minor limitation.
2. Presence of soil water might indicate soil conditions that facilitate movement of nutrients and other contaminants into the groundwater.
3. See Table 4-6 for soil category information.
4. ETA systems are only suitable for use with secondary treated effluent in category 6 soils.
5. May require soil amelioration where a moderate or major limitation is identified (see Figure 4-4).
6. Soil is likely to become more sodic with effluent application.

Table 4-5 indicates the level of soil assessment recommended for subdivisions, single sites and for tiny houses. Whilst relevant data may be brought forward from earlier broader scale studies, all single sites require investigation of all parameters as part of a single lot wastewater design.

Table 4-5: Soil Test Data Required for Different Situations

Soil Test, Method and Reference	Subdivision	Single Site	Tiny Houses ¹
Soil pH (1:5 soil:water)	Yes	Yes	No
Electrical conductivity (1:5 soil:water) Conversion to ECe necessary	Yes	Yes	No
Cation exchange capacity and exchangeable cations, exchangeable sodium percentage	Yes	No	No
Phosphorus sorption	Yes (composite to 0.75m for irrigation or limiting layer within 0.6m of point of application for absorption systems)	Yes, if data not available for relevant soil landscape(s) from eSPADE	No
Modified Emerson aggregate test (SAR 5)	Yes	Yes	Yes
Soil texture and structure category	Yes	Yes	Yes
Saturated hydraulic conductivity	For category 5b, 5c and 6 soils only	For category 5b, 5c and 6 soils only	No
<p>NOTES:</p> <p>'Yes' - Means for all major soil horizons down to and including the limiting layer 0.6m below the point of application.</p> <p>1. See Section 4.4 for conditions applicable to tiny house developments.</p>			

Depth of Soil

Soil depths of less than 0.6 metres to a limiting layer might not have sufficient assimilative capacity for the hydraulic, nutrient and pathogen loads. Shallow soil depths are often highly variable and variable soil depth under effluent application systems should be investigated to confirm the presence of adequate soil depth beneath the whole EAA. Where soil depth is less than 0.6 metres beneath the point of application, suitable soil should be imported to increase the separation distance or by construction of a raised bed or mound.

Depth to Episodic/ Seasonal High Water Table

The depth to the seasonal high water table level can be assessed through observation and assessment of characteristics such as soil colour, mottling, nodules and concretions. Mottles are spots, streaks, speckles or blotches of different from the soil matrix colour. Soil colour can be assessed using the Munsell colour chart. Bright, uniform soil colours typify well drained, well aerated soils. Dull, grey or

mottled soils indicate continuous or seasonal saturation. A bleached A₂ horizon can indicate poor drainage and a perched water table. Iron, iron-manganese, manganese or aluminium nodules within a soil profile generally indicate alternate wetting and drying with periodic waterlogging.

If the seasonal high water table lies within 0.6 metres of the point of application, soil should be imported to increase the separation distance between the point of application and the limiting layer or by construction of a raised bed or mound. This then allows 0.6 metres of free-draining soil in which further treatment can occur. This assists with protection of groundwater and surface water by maintaining aerobic conditions in the soil and reduces risk of groundwater contamination.

Attention should be given to groundwater protection, particularly if the groundwater is used or may be used for potable or irrigation water supplies. In such areas, consider baseline and ongoing groundwater monitoring to allow both the detection of deteriorating groundwater quality and protection of aquifers.

Once a particular contaminant has reached the groundwater, the rate of transport will be much greater than in the unsaturated zone, and movement will be in the direction of the regional groundwater flow. Pathogens can be carried significant distances in this zone (Hoxley and Dudding 1994).

Soil Permeability

Saturated hydraulic conductivity (permeability) is a measure of the ability of a soil to transmit water. From the perspective of wastewater design, the hydraulic conductivity of the least permeable (limiting) layer within 0.6 metres of the point of application of effluent is used to assign the hydraulic loading rate. The hydraulic conductivity is a measure of a range of soil characteristics including texture, structure and porosity.

In general, highly permeable soils such as gravels and sands can allow effluent to percolate rapidly through the soil profile, but have greater potential for pathogens and nutrients to impact groundwater and travel off-site. Low permeability soils allow effluent to percolate much more slowly, can encourage waterlogging and surfacing of the applied wastewater, yet have greater potential for assimilation of contaminants.

Permeability can be calculated by a field assessment using a constant head permeameter and estimated by field or laboratory assessment of soil texture and structure. Indicative permeability, determined by one or both of these means, is used to assign hydraulic loading rates for effluent (see Table 4-6).

Permeability assessment should be undertaken by a suitably qualified and experienced assessor with the necessary skills in soil science.

Soil texture relates to the relative proportions of clay (<0.002 mm diameter particles), silt (0.002 - 0.02 mm diameter particles) and sand (0.02 - 2.0mm diameter particles) in the soil.

Soil structure refers to the aggregation of soil particles into clusters, called peds, that are separated by surfaces of weakness (partings, openings, voids) This can greatly modify the influence of soil texture on water movement. Well-structured soils with many and large voids between peds will transmit water more freely than structureless or massive soils of the same texture. Fine textured, massive soils have very low hydraulic conductivity and should only have effluent applied at very low rates.

Structure is determined by observing soil that is carefully extracted from the wall of a test pit or broken from a large block of soil which has been dug up. It cannot be adequately assessed from soils extracted by auger. Designers and regulators should assume that only the lowest hydraulic loading rates for any soil textural class can be used unless soil structure is appropriately assessed and described. Soils should be fully described in terms of their textural class and structure (pedality) and an appropriate hydraulic loading rate determined.

Table 4-6: Soil Permeability Categories Based on Soil Texture and Soil Structure

Soil Permeability Category	Soil Structure	Soil Texture
1	Structureless	Gravels and sands
2a	Weakly structured	Sandy Loams
2b	Massive	
3a	Highly/ moderate structured	Loams
3b	Weakly structured or massive	
4a	Highly/ moderate structured	Clay loams
4b	Weakly structured	
4c	Massive	
5a	Highly structured	Light clays
5b	Moderately structured	
5c	Massive	
6a	Highly structured	Medium to heavy clays
6b	Moderately structured	
6c	Massive	

If there is some doubt about the soil texture, structure or the appropriate permeability category, the hydraulic conductivity can be determined by use of a constant head permeameter such as the Talsma-Hallam, Guelph or disk permeameter or double ring infiltrometer. A liquid of similar composition to effluent (SAR 5) should be used. The results of a clean water permeability test **do not** translate directly to a hydraulic loading rate for effluent application. Measurements should be undertaken by appropriately experienced and qualified persons.

A falling head percolation test should **not** be used to determine soil permeability.

Coarse Fragments

Coarse fragments are those particles larger than 2 mm in diameter. Coarse fragments create preferential flow paths for effluent and reduce the capacity of the soil to assimilate contaminants. They can pose limitations to root growth and lower the soil's capacity to supply water and nutrients to the vegetation. More than 40% coarse fragments has the potential to significantly limit the performance of effluent application systems. Coarse fragments can also interfere with trench and bed installation and potentially cause damage to subsurface irrigation systems.

Bulk Density

Bulk density is the mass of dry soil per unit volume. It is a measure of soil mineralogy, porosity and structure. Hazelton & Murphy (2016) describe soils of specific textures having typical bulk densities as follows:

- Sandy loam: ~1.8 g/cm³ (grams per cubic centimetre);
- Loam and clay loam: ~1.6 g/cm³;
- Clay: ~1.4 g/cm³.

pH

The pH of a soil can affect vegetation growth. Soil pH also affects the solubility and fixation of some nutrients in soils. Soils with a pH of between 4.5 and 8.5 generally pose few constraints for EAAs. Acid soils with pH <4.5 should be ameliorated by addition of lime. Guidance on suitable application rates can be found on the NSW DPI website.

Electrical Conductivity

High Electrical Conductivity (EC), corresponding to a high concentration of soluble salts in a soil may inhibit vegetation growth. Salt concentration in soil is indicated by the EC of a 1:5 soil:water suspension measured using a calibrated meter. To convert EC 1:5 deciSiemens per metre (dS/m) to ECe (Electrical Conductivity of saturated Extracts) a multiplier factor related to the soil texture is required (see Hazelton and Murphy 2016). The tolerance of vegetation species to soil salinity varies among vegetation types. An ECe of greater than 4 dS/m is suggested as a limit above which vegetation growth problems can occur.

Sodicity

The level of exchangeable sodium cations in a soil is referred to as sodicity. It relates to likely dispersion on wetting, and shrink/ swell properties. Sodic soils tend to have low infiltration capability, low hydraulic conductivity, and a high susceptibility to erosion. Exchangeable Sodium Percentage (ESP) is used as a measure of sodicity.

Cation Exchange Capacity

Mineral particles in soil often carry a negative surface charge. The overall neutrality of the system is maintained by the presence of cations close to the solid surface. These cations may be exchanged with others. This process is referred to as adsorption, a reversible surface phenomenon that does not involve a chemical reaction. Adsorbed cations may be retained by the soil, or used by vegetation.

The Cation Exchange Capacity (CEC) is the total number of cations a soil can retain on its adsorbent complex at a given pH, and is therefore a good measure of a soil's ability to retain specific pollutants. The most abundant cations in soil are calcium, magnesium, potassium and sodium, together with hydrogen and aluminium in acid soils. A cation exchange capacity of greater than 15 cmol+/kg is recommended for effluent application systems.

Phosphorus Sorption Capacity

The capacity of a soil to adsorb phosphorus is expressed as its phosphorus sorption capacity. A medium to high sorption capacity is greater than the equivalent of 6,000 kg/ha (approximately 375mg/kg) (considered to be active to 100 cm below effluent application level) and is preferred for EAAs. Phosphorus sorption by the soil is expected to occur up to about a quarter to half of the phosphorus sorption capacity. Beyond this, leaching of phosphorus can occur if the phosphorus is not used by vegetation uptake. A soil with a phosphorus sorption ability of at least 50 years (in terms of mg P/kg soil), based on the expected phosphorus load, is recommended for EAAs.

In the absence of first-hand data from field derived samples or other published data such as data available on eSPADE for the corresponding soil landscape, the following values from Table 4-7 can be used:

Table 4-7: Typical P-sorption Values

Soil Category	Texture	Typical P-sorption (mg/kg)
1	Gravels and sands	50

2	Sandy loams	100
3	Loams	200
4	Clay loams	400
5	Light clays	500
6	Medium-heavy clays	600
NOTES:		
Adapted from 'Designing and Installing On-site Wastewater Management Systems' from WaterNSW (2023a)		

Dispersion class

The Modified Emerson Aggregate Test is a simple assessment of aggregate dispersion based on a two-hour testing period. Three undisturbed samples of soil aggregate about 5 mm in diameter, are each carefully immersed in a beaker of Sodium Adsorption Ratio (SAR) 5 solution and left undisturbed for two hours. The behaviour of the natural aggregate can be used as a guide to assess whether a soil is prone to dispersion. Testing is completed to AS1289 technique.

Dispersive soils pose limitations to OWM because of the potential loss of soil structure when effluent is applied. Soil pores can become smaller or completely blocked, causing a decrease soil permeability, which can lead to system failure.

4.4 Site and Soil Evaluation Requirements for Tiny Houses

Recommended SSE for tiny houses recognises the reduced risk associated with smaller OWMSs for such lower occupancy dwellings and consequently require a reduced range of investigation and testing whilst still providing a sound basis for design of appropriate effluent application systems. These requirements only apply to single freestanding tiny houses and similar small dwellings such as glamping accommodation. Contact the relevant water authority for sites located within a drinking water catchment.

SSE Tiny House Summary

The following requirements for SSE only apply to tiny houses (or similar) with:

- One bedroom
- Maximum three people occupancy
- A stand-alone OWMS
- Only has a composting toilet, no full-flush toilet
- Only generates wastewater from a kitchen sink, washbasin, laundry and shower
- No bath, spa bath or dishwasher

The daily design wastewater load is 275 litres and includes an allowance for leachate from the composting toilet. Both the leachate from the composting toilet and the greywater should be treated in a minimum AS/NZS 1546.1 accredited 1,350 litre septic tank. The primary treated effluent must be

land applied subsurface to a bed of 0.4 metre minimum depth. Only one soil test pit or borehole, located at the mid-point of the proposed application bed and excavated to a depth of 1.0 metre is required. The only soil testing required is one soil textural test and a Modified Emerson Aggregate Test of the soil which comprises the limiting layer. The DLR is based on the limiting layer within 0.6 metre of the point of application. If the soil sample is dispersive, the soil should be considered a Category 6 soil. The effluent is to be applied to the mid-point of a bed or beds of minimum width of 1.0 metre and maximum width of 2.0m. Maximum individual bed length is 20 metres. Where two beds are required spacing between beds is a minimum of 1.0 metre. Beds are to be constructed on the contour.

Table 4-8: Tiny House Required Bed Lengths

Soil Category	Basal area required (m ²)	Bed length required for 1m wide bed(s) (m)	Bed length required for 2m wide bed(s) (m)
1	14	14	7
2	18	18	9
3	28	2 beds x 14	14
4	55	3 beds x 19	2 beds x 14
5	55	3 beds x 19	2 beds x 14
6	55	3 beds x 19	2 beds x 14

Multiple bed configurations require a distribution box (see Section 6.6.1).

Section 5: Onsite Wastewater Management System Options



Section 5. Onsite Wastewater Management System Options

5.1 Introduction

Total onsite management of domestic wastewater involves the treatment and application of all the wastewater within the boundaries of the premises on which the wastewater was generated. Sustainable approaches to Total Onsite Wastewater Management (TOWM) should consider the contaminants present in wastewaters and the potential contaminant pathways that could lead to off-site migration of pollutants. Figure 5-1 outlines the approach to achieving TOWM.

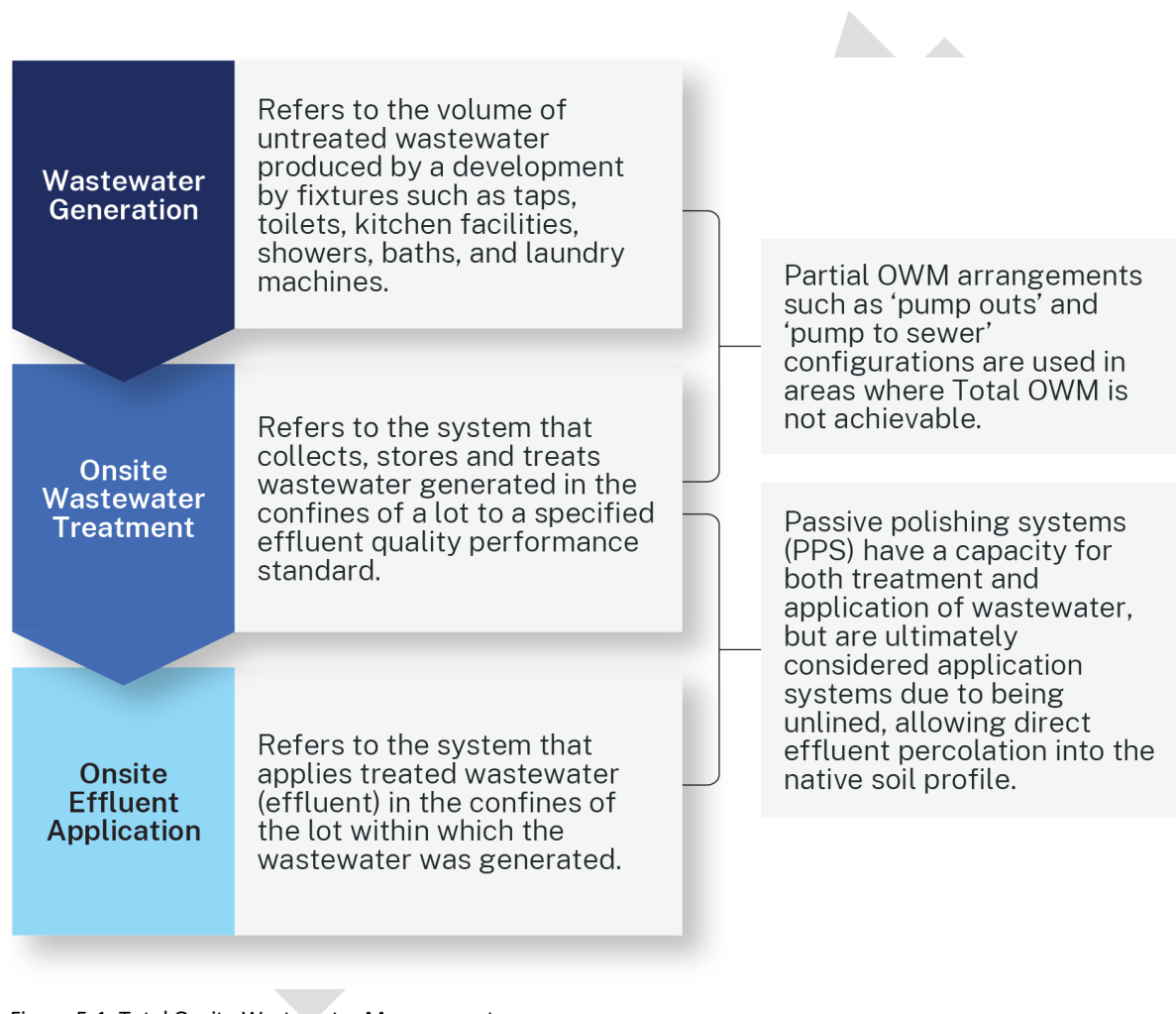

Figure 5-1: Total Onsite Wastewater Management

5.1.1 Characteristics of Domestic Wastewaters

Domestic wastewaters are those originating from households or personal activities including water closets, urinals, kitchens, bathrooms and laundries. It can include wastewater flows from facilities serving staff, employees, residents or guests in institutional, industrial, commercial or recreational establishments but excludes trade wastes from industrial, commercial or home business sources.

Treatment systems covered by this Guideline include those capable of treating domestic wastewater with a daily flow of up to 5,000L/day.

Any system capable of servicing greater than 5,000L/day is considered a commercial treatment system. Commercial treatment systems are not covered in this Guideline and should be designed by a suitably qualified and experienced wastewater consultant due to the higher level of investigation required.

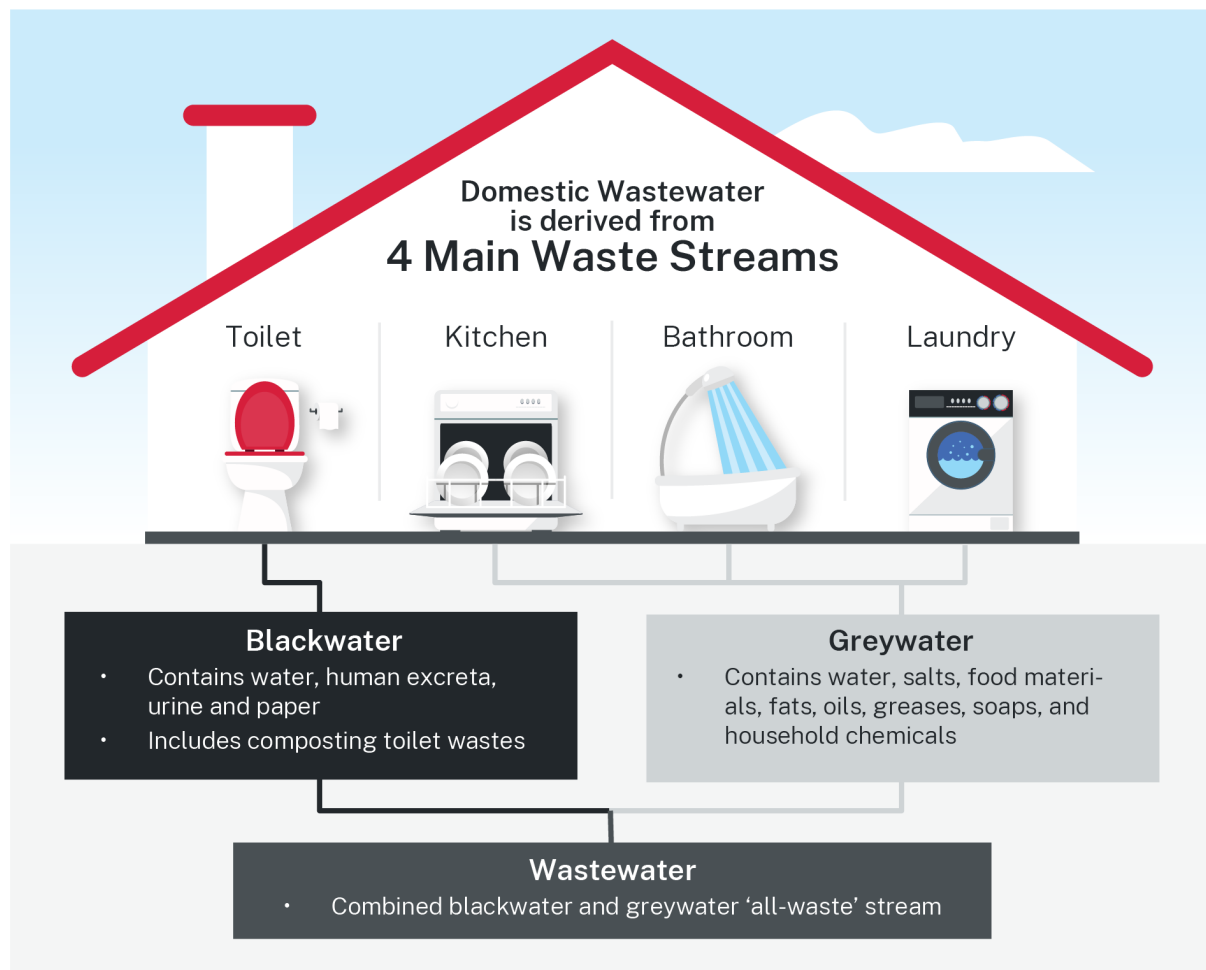

Figure 5-2: Waste Streams of Domestic Wastewater

Figure 5-2 outlines the main waste streams that make up domestic wastewaters.

Domestic wastewaters contain various components that can be considered Constituents of Concern (COC) when disposed into the environment incorrectly. The two main risks that arise from the COCs present in wastewater when released inappropriately into the environment include:

- **Public health risks** arising from pathogenic microorganisms present in varying concentrations in untreated wastewater and treated effluent that have the potential to cause disease when exposed to humans and animals.
- **Environmental pollution risks** arising from the physical, chemical or biological constituents in wastewaters that alter normal ecosystem functioning of sensitive receptors such as surface waters and groundwaters.

Consideration should be given to the range of contaminant pathways that may result in public health or environmental pollution risks. Effluent that is land applied at the surface level or subsurface level within a premises may be transported through the soil and water and cause water quality or public health issues elsewhere not known to the OWMS owner. Table 5-1 outlines the constituents present in untreated domestic wastewater and their potential effect in the environment.

Table 5-1: Constituents in Untreated Domestic Wastewater

Wastewater Constituent	Description	Effect in the Environment
Water	<ul style="list-style-type: none"> ● Major component of wastewater ● Is present in combination with various dissolved, colloidal and solid constituents ● Measurement - daily hydraulic load 	<ul style="list-style-type: none"> ● Not considered a contaminant itself ● Acts as a solvent and transport mechanism for the various constituents present in wastewater
Organic Matter	<ul style="list-style-type: none"> ● Consists of chemical compounds based on carbon skeletons (proteins, carbohydrates and fats) ● Can be present in dissolved, suspended and colloidal form ● Measurement - Biochemical Oxygen Demand (BOD₅) 	<ul style="list-style-type: none"> ● Consumes dissolved oxygen as it decomposes in waterways causing a deterioration in water quality harmful for aquatic plants and animals
Suspended Solids	<ul style="list-style-type: none"> ● Comprise the proportion of particulate materials that are suspended in solution rather than dissolved ● Can be retained after passing through a glass fibre filter ● Measurement - Total Suspended Solids (TSS) 	<ul style="list-style-type: none"> ● Reduces water clarity and light penetration through the water column of a waterway, deteriorating water quality and impacting photosynthetic aquatic organisms
Nutrients	<ul style="list-style-type: none"> ● Chemical elements that are essential for biological growth ● Nitrogen (N) and Phosphorus (P) are the principal nutrients of concern with respect to domestic wastewater ● N in wastewater is typically found in one of four forms: ammonia, ammonium, nitrite and nitrate ● P in wastewater is typically found in one of three forms: orthophosphate complexes, polyphosphate and organic phosphate ● Measurement - may be reported by individual components or as the combination of all forms present. The combined analysis of all forms of N and P is referred to as the Total N (TN) and Total P (TP) 	<ul style="list-style-type: none"> ● Nutrient enrichment of waterways causes excess plant and algal growth as nutrients are limiting factors for growth ● This process, known as eutrophication, causes surface scums to block light penetration and reduce dissolved oxygen levels in waterways which can result in aquatic life die-off (e.g. fish kill events)
Pathogens	<ul style="list-style-type: none"> ● Disease-causing microorganisms (bacteria, protozoa and viruses) ● Present in high numbers in untreated domestic wastewater and some treated effluents ● Measurement - analytical methods for the detection of pathogens are 	<ul style="list-style-type: none"> ● Potential to cause diseases (e.g. gastroenteritis, skin infections, Hepatitis A, or Leptospirosis) ● Humans or animal contact through aquatic recreational activities, ingesting contaminated food (i.e. edible crops irrigated by partially

	<p>generally expensive and time consuming. Indicator organisms are those organisms whose presence is indicative of faecal and pathogenic contamination and are commonly used in favour of pathogen-specific detection methods</p> <ul style="list-style-type: none"> • The most common indicator organism is the bacteria <i>Escherichia coli</i> or '<i>E. coli</i>'. <i>E. coli</i> is reported in colony forming units (cfu) present in a 100mL sample • Note that faecal coliforms are a poor indicator of pathogenic viruses such as hepatitis A, norovirus and protozoa. Where virus load in effluent is a key consideration, disinfection units should be included as an additional barrier 	<p>treated wastewater or oysters grown in a waterway affected by wastewater pollution) or by contact with failed OWMS components</p>
Sodium	<ul style="list-style-type: none"> • May be present in domestic wastewaters from household chemicals such as laundry detergents, soaps and cleaning products • Measurement - Sodium Adsorption Ratio (SAR), which relates the amount of sodium ions relative to the amounts of calcium and magnesium ions 	<ul style="list-style-type: none"> • Increases the salinity of waterways and reduces freshwater organism biodiversity • Damage to soil structure
pH	<ul style="list-style-type: none"> • Indicator of the acidity or alkalinity of the liquid part of wastewater 	<ul style="list-style-type: none"> • Increases in acidity or alkalinity in waterways are harmful to aquatic plants and animals • Changes in pH can change availability of nutrients, sometimes to toxic levels
Fats, Oils and Greases (FOG)	<ul style="list-style-type: none"> • Commonly derived from kitchen activities particularly frying 	<ul style="list-style-type: none"> • Float on the top of the water column within a waterway and form oil surface scums harmful to aquatic plants and animals

5.1.2 Non-domestic Development and Home Businesses

Non-domestic development, including home businesses can have significantly different wastewater characteristics to domestic development. This can influence the volumes, flow rates and proportions of constituents and can include differing constituents, including BOD, FOG and chemicals, and will influence the suitable treatment required. The design of a treatment system for non-domestic wastewater should be completed by a suitably qualified and experienced wastewater consultant due to the higher level of investigation required.

If these differences are not addressed and a domestic treatment system is used, the performance of the treatment system may be impacted as domestic systems are designed for an expected range of characteristics.

It is at the local council's discretion if non-domestic development and home businesses operating on an OWMS are required to follow the NSW DPIE Liquid Trade Waste Management Guidelines (2021), which provide details of the required pre-treatment prior to discharge for many business types, with the intention of minimising the impact of the trade waste on the local council's wastewater treatment system.

5.2 Onsite Wastewater Treatment Performance Standards

5.2.1 Performance Based Design

Wastewater, no matter where it comes from, can transmit disease and cause environmental damage. Therefore, it should not be applied to land without treatment. Treatment processes are imperative in mitigating the potential for public health and environmental pollution risks associated with untreated wastewater. Performance-based designs are recommended for designing treatment systems.

Performance Based Design Summary

Performance based design is an approach to achieving performance that allows designers to develop solutions to achieve a numerical performance requirement (e.g. effluent quality performance criteria specified by relevant Australian Standards) that can provide for flexibility and innovation in design, based on the results of the SSE.

A **treatment train** is defined as the sequence of compatible unit operations that connect the source of the wastewater to an intended application or recycling option.

Unit operations refer to individual treatment processes or the physical facilities in which a physical, chemical and/ or biological process is made to occur for the purpose of removing or destroying a COC.

5.2.2 Effluent Quality Performance Standards

NSW Health provides a certificate of accreditation for domestic treatment systems that have demonstrated conformance with the effluent quality standards prescribed by the relevant NSW Health Accreditation Guideline which takes into consideration Australian and New Zealand standards.

The level of treatment determines the quality of effluent available for effluent application options. Table 5-2 provides an outline of the performance standards required for the different levels of treatment and the application options permitted with each. Tertiary treatment unit processes are considered separately in this table, as they may be combined with differing levels of treatment, secondary or greater treatment, within a treatment train.

5.2.3 Greywater Quality Performance Standards

Greywater Treatment Systems (GTS) use a combination of primary, secondary and tertiary treatment processes. The treatment level of a specific GTS is provided in the associated NSW Health Certificate of Accreditation.

Greywater System and Devices Summary

Greywater Treatment Systems (GTS) are waste treatment devices intended to process the greywater component of wastewater from hand basins, showers, baths, washing machines, laundry tubs, kitchen sinks and dishwashers. GTS are a 'Sewage Management Facility' (SMF) under the LG Regulation and require a NSW Health Certificate of Accreditation.

Greywater Processing Devices (GPD) are devices that receive greywater from shower, bath and washing machine rinse water (no kitchen, laundry tub, washing machine wash water or dishwasher waste stream) and have the capacity to produce recycled water for toilet, washing machine and garden use. GPD are a 'SMF' under the LG Regulation, but do not require a NSW Health Certificate of Accreditation.

Greywater Diversion Devices (GDD) are devices which divert greywater, except kitchen wastewater, generated by a premises to the garden or lawn for use in subsurface application. GDD are not a 'SMF' under the LG Regulation and do not require a NSW Health Certificate of Accreditation.

This **Guideline only covers the use of GTS in unsewered areas**. The local council is the regulator responsible for GTS, GPD and GDD systems and any use of these systems within unsewered areas requires approval by the local council under the LG Act. Refer to NSW Health Advisory Note 7 Greywater Processing Devices (GPD) Single Domestic OWM for further information.

Any OWM design incorporating a GTS, GPD, GDD must account for the management of all wastewater components not treated by the greywater unit installed or in addition to the reuse volumes available within the dwelling.

See NSW Health Advisory Note 7 Greywater Processing Devices (GPD). Single Domestic Onsite Wastewater Management (2021).

Table 5-3 provides an outline of the performance standards required for the different levels of GTS and the recycling options permitted with each treatment level within single dwelling households. For multi-dwelling residential developments, motels childcare facilities and schools, greywater recycling should be limited to subsurface irrigation systems only to reduce risk.

Table 5-2: Wastewater Treatment Performance Standards and Suitable Treatment System and Effluent Application Options

Treatment Level	Description	Performance Standard ^{1, 2}	General Effluent Quality and Characteristics ²	Treatment System or Unit Operation Capable of Achieving Performance Standard	Effluent Application Options for Treatment Level ^{3, 4}
Primary Treatment	Processes and unit operations that remove suspended solids (organic and inorganic) from wastewater by sedimentation, floatation and anaerobic digestion processes.	No standard exists for primary treatment.	150mg/L BOD ₅ 50mg/L TSS 10 ⁵ -10 ⁷ cfu/100mL <i>E. coli</i> 10-15mg/L TP 50-60mg/L TN	Septic Tanks	Absorption trenches/ beds EvapoTranspiration Absorption (ETA) trenches/ beds Wick systems Low Pressure Effluent Distribution (LPED) Passive Polishing Systems (PPS) including mounds
				Wet Composting Systems (WCS) ⁵	
				Waterless Composting Toilet (WCT) systems	
Secondary Treatment	Processes and unit operations that follow primary treatment and are designed to remove biodegradable dissolved and colloidal organic matter by aerobic biological processes.	≤20mg/L BOD ₅ ≤30mg/L TSS	10 ⁴ cfu/100mL <i>E. coli</i> 10-15mg/L TP 25-50mg/L TN	Aerated Wastewater Treatment System (AWTS)	All subsoil primary options Subsurface Irrigation (SSI)
				Aerobic Sand and Media Filter Systems (ASMFS) ⁶	
				Constructed Wetlands ⁶	
				Mounds/ PPS ⁹	
Advanced Secondary Treatment	Processes and unit operations that follow secondary treatment and include biological transformation processes.	≤10mg/L BOD ₅ ≤10mg/L TSS	10 ⁴ cfu/100mL <i>E. coli</i> 10-15mg/L TP 25-50mg/L TN	AWTS	All subsoil primary options SSI
Tertiary Unit Process: Disinfection	Processes and unit operations that are designed to destroy pathogenic microorganisms.	≤30 cfu/100mL <i>E. coli</i> ⁷	See effluent quality characteristics for treatment	Chlorination	All subsoil primary options SSI
				Ultra-Violet (UV) radiation	

Treatment Level	Description	Performance Standard ^{1, 2}	General Effluent Quality and Characteristics ²	Treatment System or Unit Operation Capable of Achieving Performance Standard	Effluent Application Options for Treatment Level ^{3, 4}
	Disinfection can be combined with secondary, advanced secondary and/ or nutrient reduction treatment processes.	≤10 cfu/100mL <i>E. coli</i> ⁸	level unit operation is combined with	Ozone Microfiltration and/ or membrane filtration	Surface Irrigation (SI)
Tertiary Unit Process: Nutrient Reduction	Processes and unit operations that are designed to reduce the level of TN and TP. Nutrient reduction is a unit process that can be combined with secondary, advanced secondary and/ or disinfection treatment processes.	No standard exists for nutrient reduction. Refer to NSW Health accreditation for system-specific nutrient reduction capabilities.	See effluent quality characteristics for treatment level unit operation is combined with	AWTS Amended soil mounds ASMFS Constructed Wetlands	See application options for treatment level unit operation is combined with

NOTES

1. Performance standards apply as the 90th percentile and are based on the relevant Australian and New Zealand Standard.
2. Where: BOD₅ = Biochemical Oxygen Demand; TSS = Total Suspended Solids; cfu = colony forming units; TP = Total Phosphorus; and TN = Total Nitrogen.
3. Combination of treatment and application subject to SSE as per AS/NZS 1547:2012.
4. Application options include all lower treatment standard uses.
5. Some WCSs may be accredited for higher levels of treatment. Refer to NSW Health accreditation certificate.
6. NSW Health accreditation certificate not required for site-specific designs.
7. Disinfection performance standard when unit operation combined with secondary treatment.
8. Disinfection performance standard when unit operation combined with advanced secondary treatment.
9. Excluding amended soil mounds.

Table 5-3: GTS Quality Performance Standards and Suitable Recycling Options for Single Dwelling Households

Greywater Treatment Level ¹	Performance Standard ^{2, 3}	Recycling Options	
		Outdoor Use	Indoor Use (subject to local council approval)
Level 1	≤ 10 mg/L BOD ₅ ≤ 10 mg/L TSS ≤ 2 NTU ≤ 1 cfu/100mL <i>E. coli</i>	Hand-held hose for car washing and/ or garden watering SSI SI ⁴	Cold water supply to automatic washing machines Toilet flushing
Level 2	≤ 10 mg/L BOD ₅ ≤ 10 mg/L TSS ≤ 2 NTU ≤ 10 cfu/100mL <i>E. coli</i>	SSI SI ⁴	Toilet flushing
Level 3	≤ 20 mg/L BOD ₅ ≤ 30 mg/L TSS ≤ 10 cfu/100mL <i>E. coli</i>	SSI	Indoor recycling uses of greywater are not permitted for greywater that has been treated to a Level 3 standard

NOTES

- Adapted from Table 2.1 AS 1546.4:2016.
- Performance standards apply as the 90th percentile and are based on AS 1546.4:2016.
- Where: BOD₅ = Biochemical Oxygen Demand; TSS = Total Suspended Solids; NTU = Nephelometric Turbidity unit; and cfu = colony forming units.
- Surface irrigation is only acceptable as covered surface drip or spray irrigation using fixed or pop-up sprinkler systems.

5.3 Primary Treatment Systems

5.3.1 Septic Tanks

Septic tanks provide primary treatment by sedimentation of solids on the base of the tank (the 'sludge' layer) and floatation of fats, oils and greases on the surface of the water (the 'scum' layer) allowing clarification of wastewater in the middle zone as it flows through to the outlet. A fully formed scum layer prevents the entry of oxygen into wastewaters enabling anaerobic digestion of organic matter facilitated through anaerobic microorganisms and prevents the escape of odours.

A baffle or partition is included in the system configuration when the tank is greater than 2,050L capacity (NSW Health 2016) to divide the septic tank into two compartments. This prevents flow short-circuiting and reduces the potential carryover of solids. An outlet filter is recommended to be fitted with the purpose of capturing large suspended solids to minimise the potential for solids carryover.

All domestic septic tanks and collection wells must be accredited according to NSW Health SMF Vessel Accreditation Guideline (NSW Health 2016) where daily flow is up to 2kL/day and up to 10 EP. Where septic tanks and collection wells have a daily flow greater than 2kL/day or are servicing greater than 10 EP, no accreditation is required, but they must comply with the intent and content of AS/NZS 1546.1.

Local councils should not permit the discharge of septic tank septage into a sewerage system without the prior approval of the local water authority.

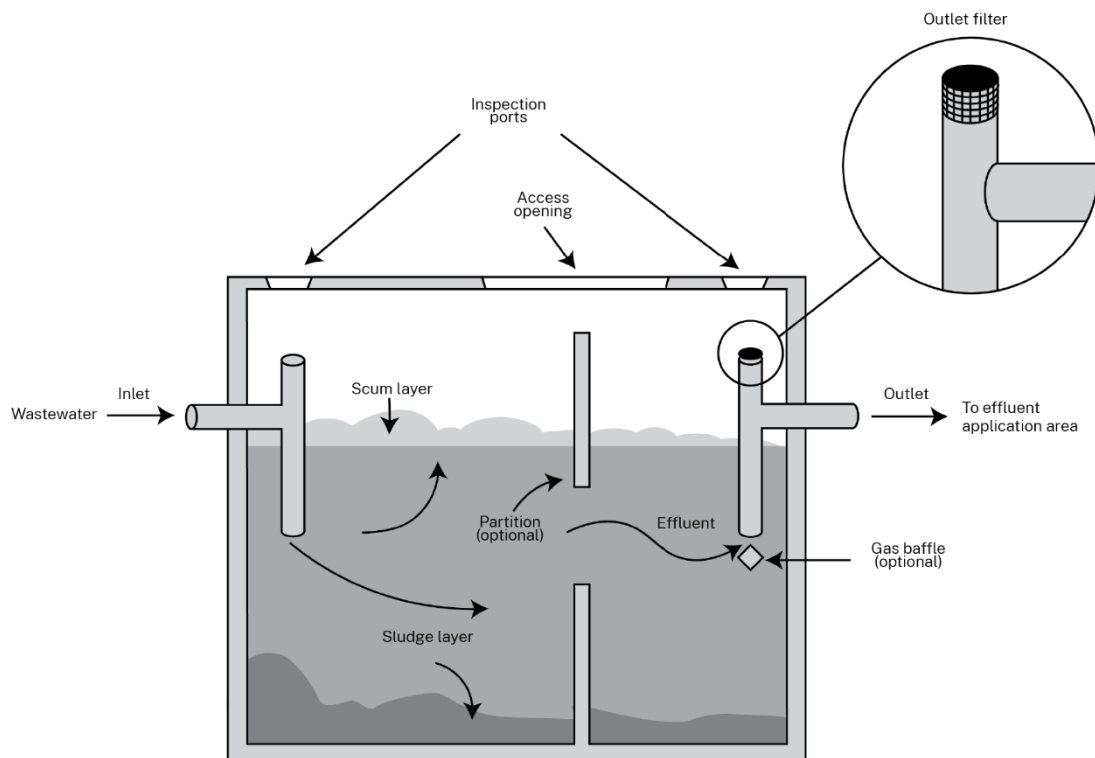

Figure 5-3: Typical Schematic of Septic Tank System

Adapted from Designing and Installing On-site Wastewater Management Systems from WaterNSW (2023a)

5.3.2 Wet Composting Systems

Referred to as WCS, vermiculture systems or worm-farm systems. WCS rely on microorganisms, worms and/ or beetles to break up organic matter into humus. These systems are typically comprised of layered filter beds and incorporate vermiculture (worm-based) processes to facilitate aerobic bacteria in converting waste into humus whilst maintaining drainage and air porosity. Filter materials may include but are not limited to finely structured humus, coco-peat and geotextiles. These systems can accept kitchen food scraps in addition to wastewaters plumbed from a dwelling.

A WCS vessel must be designed according to AS/NZS 1546.1:2008 and a WCS must be accredited by NSW Health. Accredited WCSs can be found on the NSW Health 'Onsite single domestic wastewater management' website. Some wet composting systems may be capable of achieving secondary treatment with disinfection where accredited by NSW Health to do so.

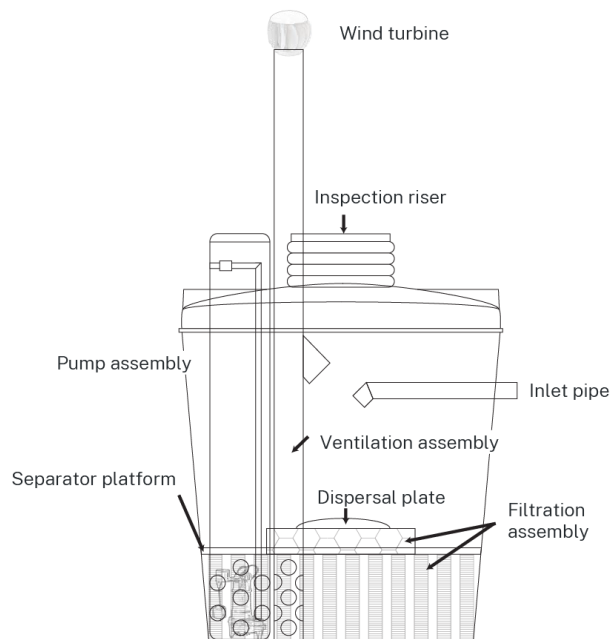

Figure 5-4: Typical Schematic of a WCS

Adapted from Zenplumb Pty Ltd

5.3.3 Waterless Composting Toilet Systems

WCT systems rely on microorganisms in an aerobic environment to decompose organic material into humus. The humus (or 'compost') and the excess liquid (or 'leachate') produced during the composting process requires separate land application, typically the leachate is directed to a trench, while the humus is buried on the site below 0.1m of soil. Waterless composting systems may be continuous flow or batch processing.

A composting unit requires a ventilation system to manage odours and help the composting process. The ventilation system generally consists of a small electric fan in the vent pipe and may require a power supply. Some WCT systems may include heating elements to facilitate drying of the material within the compost chamber.

WCT systems are useful for source-separation approaches to wastewater management (i.e. separation of blackwater and greywater) and can minimise wastewater generation. A composting toilet's performance can be significantly limited in colder climates, as cold temperatures slow the composting process. In cool temperatures a larger system or heating elements may be needed to compensate for slower decomposition of the compost.

WCT systems must be designed according to AS/NZS 1546.2:2008. WCT systems must be accredited by NSW Health or exempted under the LG Regulation. The accreditation certificate sets out the capacity of each WCT expressed in terms of EP.

Accredited WCS, WCT, septic tanks and collection wells can all be found on the NSW Health 'Onsite single domestic wastewater management' website.

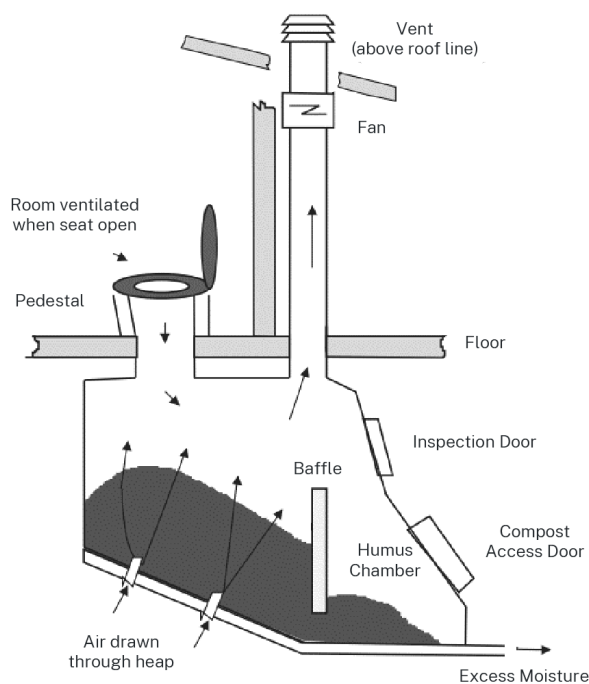

Figure 5-5: Typical Schematic of a WCT System

5.3.4 Alternative Toilets

Alternative toilet systems such as incinerator toilets and chemical toilets are less common in OWMs and are considered to be primary treatment systems.

Cesspits, otherwise known as pit toilets, are not considered to be sound for environmental or human health reasons. As such, they are not recommended as an OWMs.

Incinerator Toilets

Also referred to as combustion toilets. Incinerator toilets use bottled liquid petroleum gas and an auto-ignition device to direct a flame to incinerate human excreta once the toilet lid has been closed and locked.

Local council approval for the installation of combustion toilets as human waste treatment devices is required. The possible hazardous area created by such a device (such as in the gas bottle location) should be identified prior to approval. The unit should be maintained in accordance with the manufacturer's instructions, and the gas bottle filled regularly.

Chemical Toilets

A chemical toilet receives human excreta in a holding tank for removal by a road tanker. The holding tank is charged with a deodorising chemical. Chemical toilets may be installed as permanent fixtures (e.g. camping toilets or within a caravan) or as portable toilets for outdoor concerts, agricultural shows, special events or other short-term temporary uses. Wastewater from chemical toilets should not be disposed of into septic tanks or aerated systems, as the chemicals disrupt normal anaerobic and aerobic breakdown processes, wastewater should be disposed of at designated 'dump-points' provided by local councils.

Local council approval is needed to install chemical toilets unless exempt under the LG Regulation, and conditions might be applied, for example, on how often the waste is removed. It might be difficult to approve the installation of chemical toilets that are mounted on trailers for mobile workers crews;

in cases like these, it would be appropriate to grant the approval to the home-base of operations, subject to maintenance and waste removal conditions.

5.4 Secondary and Advanced Secondary Treatment Systems

5.4.1 Aerated Wastewater Treatment Systems

Aerated Wastewater Treatment Systems (AWTS) use aerobic treatment to promote oxidation and microbiological consumption of organic matter by bacteria through facilitated biological processes. Given enough oxygen and time, aerobic microbes (e.g. bacteria and protozoa) break down the organic matter through respiration.

Bacterial treatment processes are broadly categorised as either 'suspended growth processes' or 'attached growth processes'. Suspended growth processes refers to the biological treatment via microorganisms that are suspended in wastewaters by mixing and mechanical aeration, whereas attached growth processes refers to the biological treatment via microorganisms that grow on inert media whereby aeration is supplied mechanically or passively (e.g. trickling filters).

AWTS will typically include a primary chamber, aeration chamber, clarification chamber, a disinfection unit and a pump chamber. AWTSs may include fixed or Floating Media (FM) systems, Activated Sludge (AS) units, Sequencing Batch Reactors (SBR), Rotating Biological Contactor (RBC) systems, hybrid activated sludge with moving bed or attached growth media systems and Membrane Bioreactor Systems (MBR).

AWTSs require a constant and reliable power-supply for aeration processes and pump operation.

All domestic AWTS must hold a NSW Health accreditation as a secondary or advanced secondary treatment system ('Secondary Treatment System Accreditation Guideline 2018' NSW Ministry of Health 2018) and may be combined with tertiary unit operations such as disinfection and/or nutrient reduction. The accreditation certificate sets out the capacity of each AWTS expressed in terms of EP.

A condition of accreditation for AWTSs is that the owner/ occupier of the premises shall enter into an annual service contract with a suitably trained service agent.

Accredited AWTS can be found on the NSW Health 'Onsite single domestic wastewater management' website:

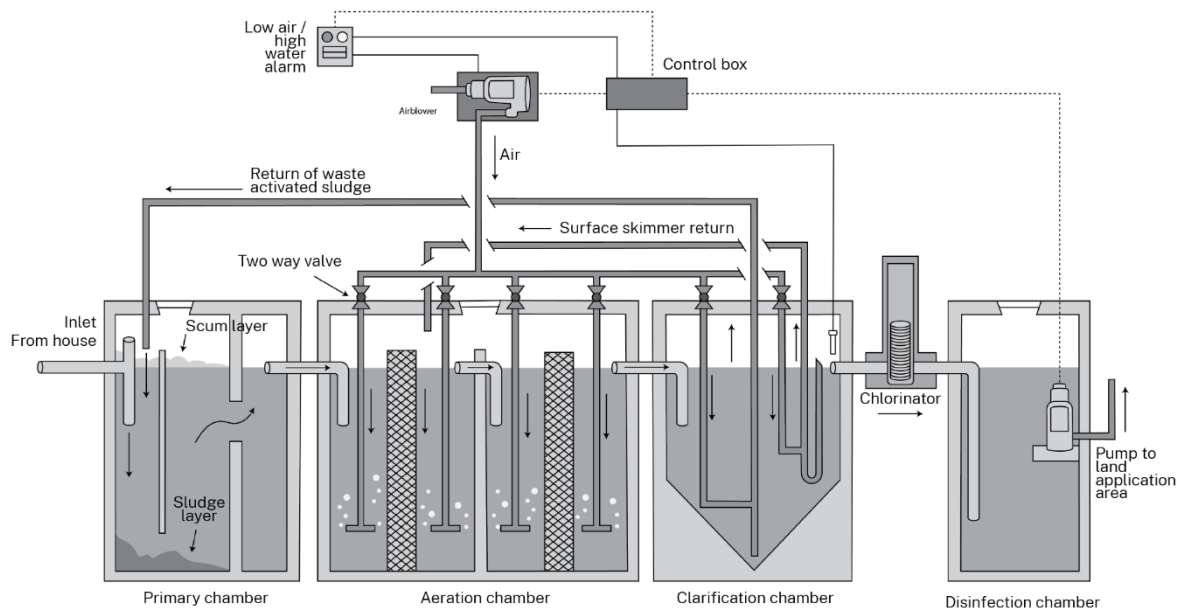

Figure 5-6: Typical Schematic of an AWTS

Adapted from *Designing and Installing On-site Wastewater Management Systems from WaterNSW (2023a)*

5.4.2 Aerobic Sand and Media Filter Systems

Aerobic Sand and Media Filter Systems (ASMFS) contain filter media (typically sand but other media can be incorporated) through which primary treated effluent is dosed via a distribution manifold for further effluent polishing. Secondary or advanced secondary effluent is collected at the base of the system in a lined underdrain and conveyed to another collection chamber or pump well for recirculation, storage and/ or disinfection of the effluent prior to effluent application. Unlined sand filters (i.e. bottomless sand filters) are not covered in this section and are categorised as Passive Polishing Systems (PPS) (see Section 5.6).

ASMFS may be configured as intermittent (single-pass) or recirculating systems. Recirculating ASMFS recycle filtrate during several passes through the unsaturated filter bed.

Alternative media filters are those commercially manufactured in modular units containing porous media that are lightweight and have a high surface area per unit volume and weight. Alternative media employed include textiles, foam, styrene plastic beads, coconut husks or peat material. These systems are commonly manufactured as commercial-scale treatment systems in NSW.

ASMFS have a higher capacity to treat intermittent and surge flows with minimal effects on treatment performance than most other secondary treatment options.

ASMFS require a pressure or low-pressure dosing mechanism to ensure even supply of effluent to the distribution manifold. ASMFS should not be approved where gravity dosing is proposed.

Sand filter systems may be constructed above ground or at or below surface level in a suitable container or retaining structure.

Certification of the sand filter media by the supplier should be required for submission to the local council upon application of the design approval. Sand used in a single pass sand filter should meet the following criteria:

- Be free of clay, limestone or organic matter;

- Contain <20% of particles >20mm;
- Contain <3% of particles <0.063mm;
- Have an Effective Diameter (D10) between 0.25mm and 1.00mm; and
- Have a Uniformity Coefficient (D60/D10) <4.

Accredited ASMFS can be found on the NSW Health 'Onsite single domestic wastewater management' website. ASMFS may be exempt from a NSW Health accreditation under the LG Regulation (refer Section 3.3.1 of the Guidelines for accreditation exemptions). ASMFS should only be approved where they have been designed and constructed by experienced wastewater professionals and take into account site-specific considerations (i.e. sizing is to be based on the potential hydraulic and organic loads generated by a development). ASMFS are to be approved only where a NSW Health accredited 'SMF' treats effluent to a primary standard prior to the ASMFS.

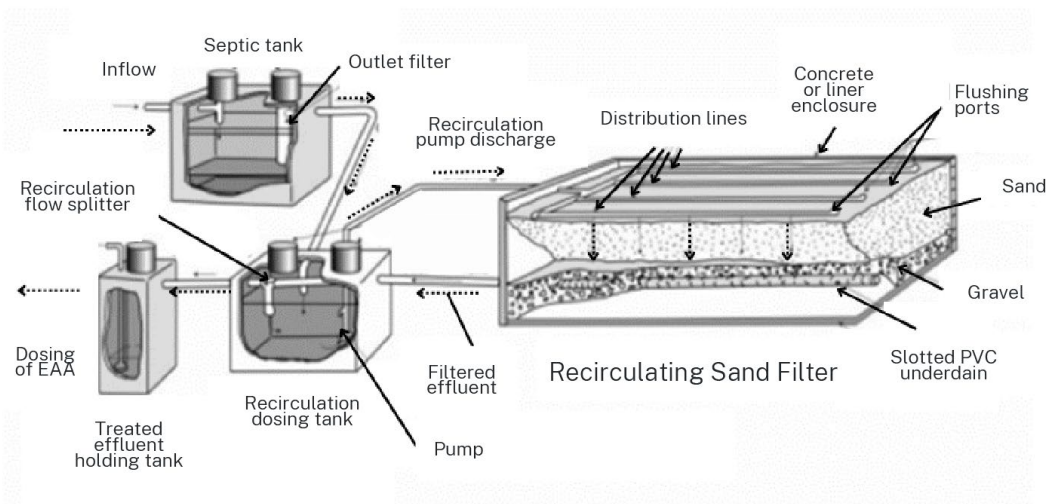
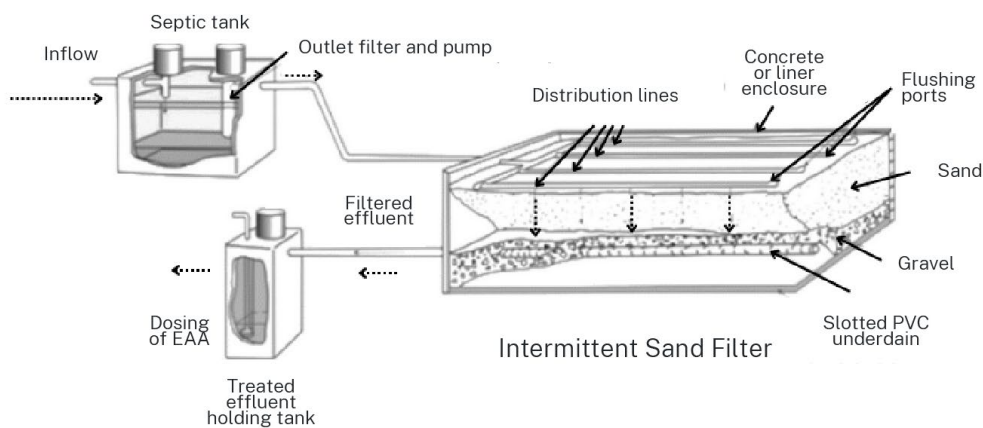

Figure 5-7: Typical Schematic of an Aerobic Sand Filter System

Adapted from Auckland Council (2021)

5.4.3 Constructed Wetlands

Constructed wetlands, specifically horizontal subsurface flow constructed wetlands, comprise a shallow gravel media bed planted with selected emergent wetland species (macrophytes), lined with

an impermeable membrane, or alternatively constructed in an impermeable pre-fabricated concrete or polyethylene container. The use of a prefabricated container is preferable over in-ground liners as the latter are more susceptible to puncturing from vegetation, vermin nesting and root intrusions. Reed beds are a common type of horizontal subsurface flow constructed wetland.

Vegetation within a constructed wetland should ideally be macrophytes (sedges, reeds and rushes) selected from local native species and should be site and climate specific. Common widespread species used include *Phragmites australis*, *Typha orientalis*, *Schoenoplectus species*, and *Baumea species*. Headley and Davison (2003) recommend that locally occurring native species that exhibit rapid and vigorous growth should be used.

Constructed wetlands rely on Hydraulic Residence Time (HRT) to achieve secondary or advanced secondary treatment of primary treated effluent. As effluent flows through the wetland, effluent is further polished through treatment processes of:

- sedimentation, filtration and adsorption processes;
- gas volatilization;
- uptake of metals and nutrients by plants;
- bacterial degradation by Ultra-Violet (UV) light,
- die-off and predation; and
- decomposition of organic matter.

Accredited constructed wetlands can be found on the NSW Health 'Onsite single domestic wastewater management' website. Constructed wetland systems may be exempt from a NSW Health accreditation under the LG Regulation (refer Section 3.3.1 of this Guideline for accreditation exemptions). Approvals for non-accredited facilities may be granted by the local council where it is designed specifically and uniquely for those premises, by a person other than the owner or occupier of the premises on which it is to be installed.

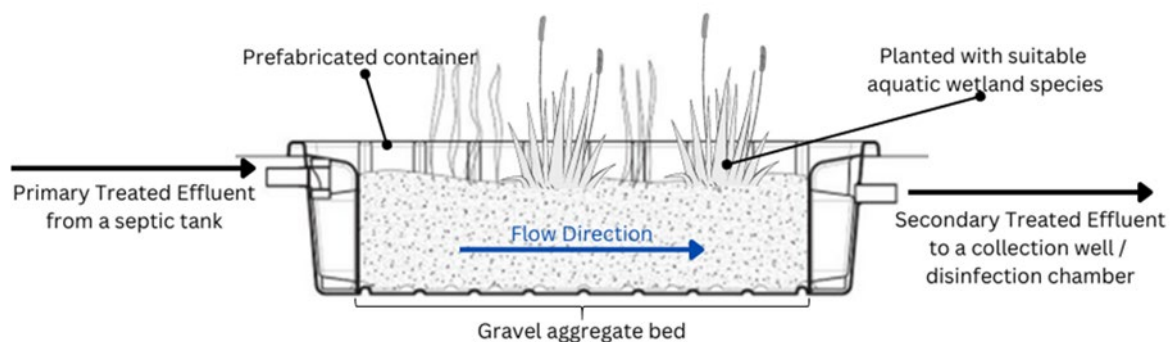

Figure 5-8: Typical Schematic of a Constructed Wetland System

Adapted from Global Roto-Moulding Pty Ltd

Constructed wetland systems should only be approved where they have been designed and constructed by experienced professionals and only where a NSW Health accredited 'SMF' treats effluent to a primary standard prior to the wetland system. Such designs for constructed wetland systems must take into account site-specific considerations (i.e. sizing is to be based on the potential hydraulic load and achieving the required HRT). Supplier or manufacturer details of any prefabricated containers should be required for submission to the local council upon application.

5.4.4 Greywater Treatment Systems

Greywater Treatment Systems (GTS) collect, store and treat greywater to an effluent quality level specified in Table 5-3 whereby each level of treatment permits differing reuse options including; at Level 1, indoor reuse for toilet flushing and clothes washing, outdoor reuse through a hand-held hose for garden watering and/ or car washing, or only within a suitable subsurface irrigation system; at Level 2 for toilet flushing; or at Level 3 for subsurface irrigation; dependent on the NSW Health accreditation and council approval.

These systems use a combination of primary, secondary and tertiary treatment processes and rely on sedimentation, floatation, anaerobic digestion, aeration, clarification and disinfection. Some GTS operate similarly to AWTs configurations; while others include membrane filtration or constructed wetland treatment technologies.

All GTS must be accredited by NSW Health under the 'Domestic Greywater Treatment Systems Accreditation Guidelines' (NSW Health 2005) and as per AS 1546.4:2016. Local councils may conditionally approve of GTS installations. A condition of accreditation approval for GTS is that the owner/ occupier of the premises shall enter into an annual service contract with a suitably trained service agent. Approvals should only be granted where the proposed GTS is accredited for the intended application or reuse method.

Accredited GTS can be found on the NSW Health 'Onsite single domestic wastewater management' website.

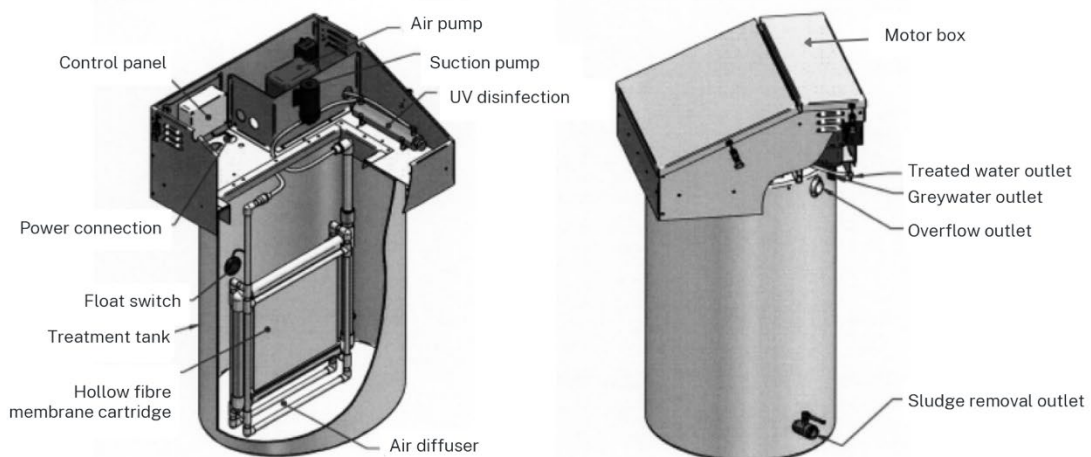

Figure 5-9: Typical Schematic of a GTS

Adapted from Wastewater Australia Pty Ltd

5.5 Tertiary Treatment Processes

5.5.1 Disinfection

Disinfection is a unit operation for the removal and/ or reduction of pathogens through processes designed to destroy pathogenic microorganisms to reduce the risk of infectious disease transmission that could result from exposure during effluent discharge and reuse application. Disinfection methods covered include chlorine, UV radiation, ozone and microfiltration/ membrane filtration.

Disinfection is used to further reduce the risk of effluent application. Disinfection should be installed in addition to subsurface effluent application where the OSMS is located in proximity to sensitive receiving waters such as drinking water catchments or oyster aquaculture areas.

Disinfection is not suitable for use with primary treated effluent.

Chlorine Disinfection

Chlorination is the most common method of disinfection in NSW, with all systems tested to AS 1546.3:2017 utilising chlorine disinfection at this time. Chlorine is effective and inexpensive, easily monitored for the effective chlorine residual, and relatively easily maintained. The process does produce disinfection by-products through the interaction between chlorine and organic matter in effluent, which can have adverse environmental and public health impacts, including degradation of metal components, including pumps if not selected to resist corrosion.

The most common chlorination method is to employ di- or tri-chloroisocyanurate tablets in an erosion feeder, which does not rely on a power supply. Chlorine dosage rates must be sufficient to ensure bacterial kill and residual chlorine concentration to prevent regrowth of pathogens. Chlorine disinfection requires water of high clarity, with turbidity typically <5NTU.

Minimum performance objectives for chlorination disinfection include:

- Free chlorine: 0.5 - 2.0 mg/L;
- E.coli: <30 cfu/100mL; and
- Contact period: 30 minutes minimum.

Ultra-violet Radiation Disinfection

UV radiation is used to penetrate cell walls and disrupt the nucleic acids and prevent reproduction. No by-products are produced by this method; however, UV disinfection is more difficult to monitor than chlorination, requires a reliable power supply and requires high water clarity, turbidity typically <1 NTU.

Ozone Disinfection

Ozone (O₃) is a highly effective oxidant and is a more effective disinfectant than chlorine. However, ozonation is a more expensive option due to being highly unstable and energy-intensive. Ozone disinfection is rarely found in domestic OWMS.

Microfiltration or Membrane Filtration

Membranes are used which allow only molecules below certain molecular weights to pass through. Effectiveness may be reduced when a build-up of a microbial layer forms and as such these systems generally require special backwashing techniques. While membrane filtration processes possess some disinfection capacity, the pore size of a membrane filter dictates its capacity for wastewater constituent removal. Microfiltration typically removes some bacteria but not viruses or dissolved salts.

5.5.2 Nutrient Reduction

Nutrient reduction is a unit operation for the removal and/ or reduction of nutrients N and P in effluent. Nutrient reduction may be achieved in unit treatment processes such as constructed wetlands and in effluent application methods such as soil absorption and evapotranspiration. Alternatively, nutrient reduction can be achieved in specialised confined units within a secondary and/ or advanced secondary wastewater treatment system, for example by chemical dosing, sorption or by electrolytic processes. Some AWTs have a NSW Health accreditation for nutrient reduction.

Nutrient reduction treatment processes have become of particular interest in areas that are considered sensitive to the introduction of nutrients and potential eutrophication processes (e.g. drinking water catchments, oyster aquaculture areas, and potable groundwater extraction areas).

5.6 Passive Polishing Systems

Passive Polishing Systems (PPS), also referred to as passive application systems, are soil based effluent application systems that receive primary (or more advanced) treated effluent and provide a degree of treatment prior to percolation directly into the natural soil ('effluent polishing'). PPS include mounds, bottomless sand filters, amended soil mounds and a variety of other proprietary PPS.

5.6.1 Regulation of PPS

PPS are not considered a 'SMF' as defined by the LG Regulation. As such, they are exempt from a NSW Health accreditation. PPS fall under the definition of being 'in relation to a SMF'. Under this definition, PPS design and installation is considered by the local council in addition to the approval of installation of a NSW Health accredited SMF.

The design, sizing, positioning and use of PPS should be in accordance with AS/NZS 1547:2012 and the local council's policies and guidelines in relation to OWM.

Minimum Performance Criteria

Designs proposing the use of a PPS must be sized by water and nutrient balance modelling where the results of the SSE indicate suitable conditions for a PPS to be installed.

Design Loading Rates (DLRs) for a PPS should reflect the degree of effluent polishing achieved within these systems. Where adequate supporting data is available to demonstrate that effluent of a secondary standard can be achieved at the point of application, DLRs for secondary treated effluent (as outlined in Table L1 and, for mounds, Table N1 of AS/NZS 1547:2012) may be used. Otherwise DLRs for primary treated effluent should be used.

5.6.2 Mounds

Sand mounds (or Wisconsin mounds) generally receive primary (or more advanced) treated effluent from a septic tank (or more advanced treatment system) which is dosed into the mound system allowing further effluent polishing to take place in the sand-fill media. Sand mounds benefit from improved evapotranspiration due to their raised position above the surrounding ground surface. Mounds should be constructed with filter sand meeting the same specifications as that described for aerobic sand filters in Section 5.4.2. Mounds using such filter media and dosed at an appropriate rate with primary treated effluent, will treat the effluent to secondary standard. The improved quality effluent discharges from the sand-fill media directly into the underlying soil. These systems are ideal to overcome site constraints associated with slowly permeable soils, shallow permeable soils over porous bedrock, and permeable soils with a high water table.

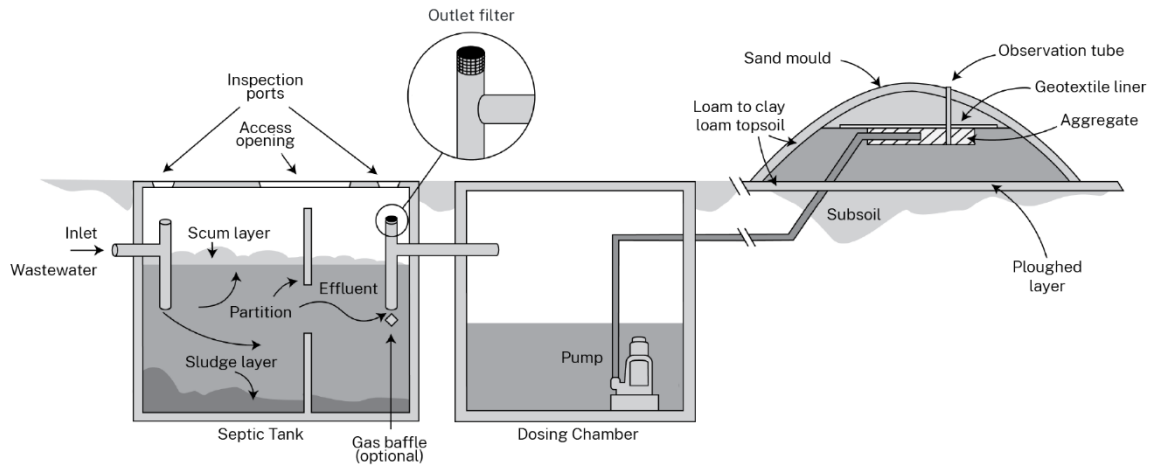

Figure 5-10: Typical Schematic of a Mound System

Adapted from *Designing and Installing On-site Wastewater Management Systems from WaterNSW (2023a)*

5.6.3 Bottomless (Unlined) Sand Filters

Bottomless sand filters act similarly to intermittent sand filters, but without a basal lining or collection system. The base of the sand filter is open to the underlying soil and effluent is further polished before draining into the native soil profile.

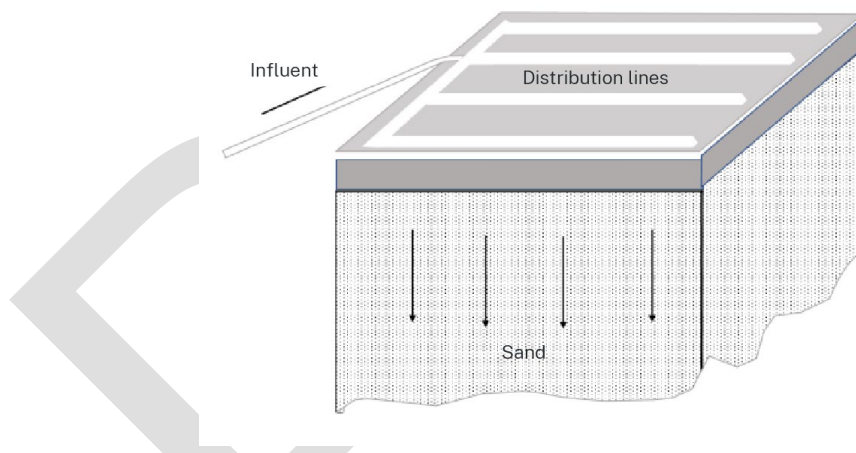

Figure 5-11: Typical Schematic of a Bottomless (Unlined) Sand Filter

Image source *Auckland Council (2021)*

5.6.4 Two-stage Proprietary Geotextile Systems

Several novel technologies have become available for use in OWM. These systems typically involve a two-stage treatment process involving primary treated effluent being dosed into a pipe that may be perforated or corrugated before distributing solids to a proprietary geotextile fabric that facilitates biofilm development and biological treatment processes. Surrounding or underlying sand wicks liquid from the geotextile and provides additional polishing prior to the effluent reaching the native soil. Free draining and unsaturated soil beneath the bed is essential for effective operation.

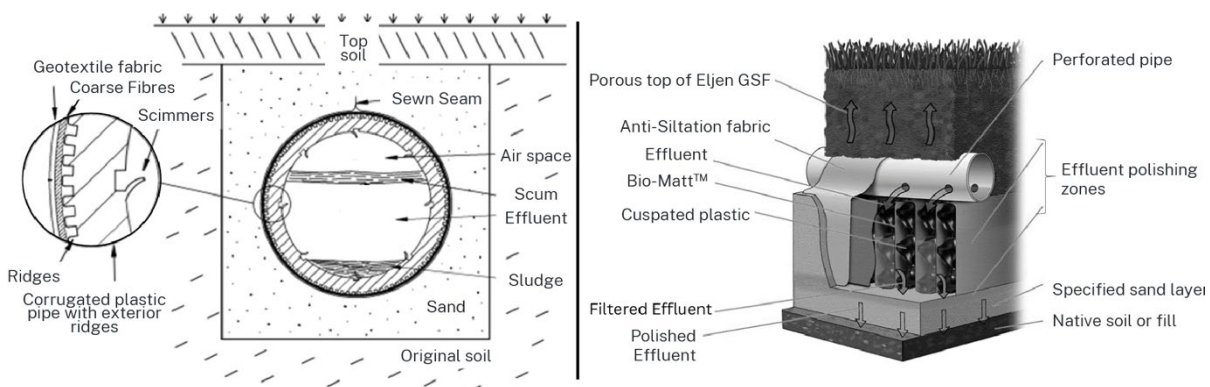

Figure 5-12: Typical Schematic of a Two-Stage Proprietary Geotextile System Showing the Advanced Enviro-Septic™ (left) and the Eljen Geotextile Sand Filter (right) Systems

Adapted from Advanced Enviro-Septic Pty Ltd and Eljen Pacific Pty Ltd

5.6.5 Recirculating Evapotranspiration Channel Systems

Recirculating evapotranspiration channel systems are constructed of either plastic or concrete and comprise a bottom gravel layer, a middle sand layer and a sandy loam topsoil layer. The channels sit in the soil profile with the channel lip remaining just above the natural ground level to prevent stormwater entry. Primary (or more advanced) treated effluent is pumped through sequential channels and is aerated via venturi valves to provide aerobic treatment. Such systems may be configured as ‘no-release’ and as such operate as a means of both treatment and application of effluent through evapotranspiration. These systems should be sized using a water balance to determine the expected frequency of pump out required in the early years of development of vegetation in the channels (pods).

The pods need to be appropriately spaced to allow for the full vegetation canopy development required to justify the water balance sizing for design.

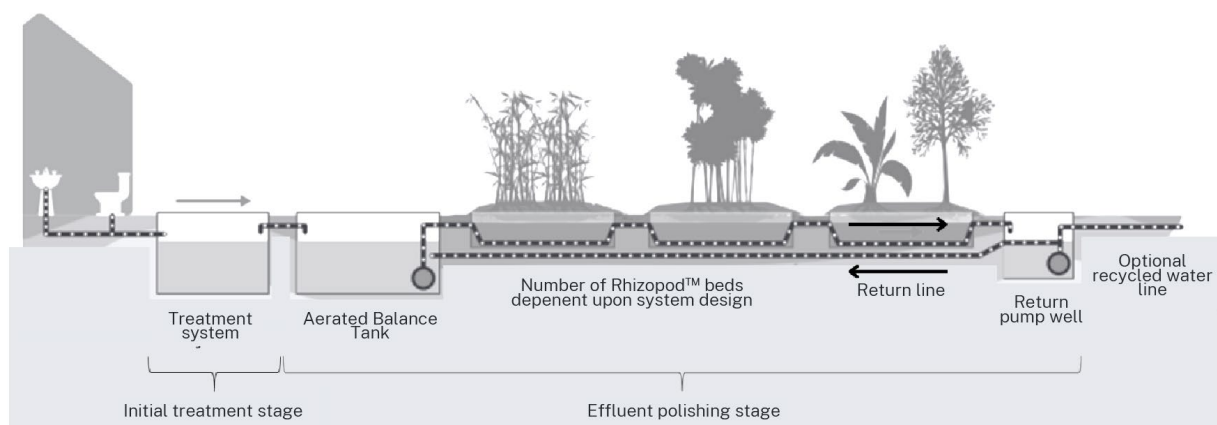

Figure 5-13: Typical Schematic of a Recirculating Evapotranspiration Channel System

Adapted from Arris Water

5.6.6 Amended Soil Mounds

Amended soil mound systems are designed to reduce the concentration of phosphorus in the effluent. Unless designed with appropriate sand filter media, they are unlikely to polish to secondary level when

dosed with primary effluent and as such their treatment capacity is limited to phosphorus removal. On sites identified as having sensitive receptors, amended soil mounds can be used to remove phosphorus from secondary treated effluent. Primary treatment systems are not recommended on sites with sensitive receptors.

The filter media in an amended soil mound system includes soil containing an industrial by-product high in iron and aluminium oxides which provides passive P sorption. Polished effluent from the amended soil overflows into the margins of a lined sand bed, i.e. the 'perimeter soakage apron', which creates an infiltration surface for polished effluent to soak away to the underlying native soil. Whilst phosphorus is removed from both primary and secondary treated effluent the final effluent quality will depend on the level of treatment provided before application to the bed.

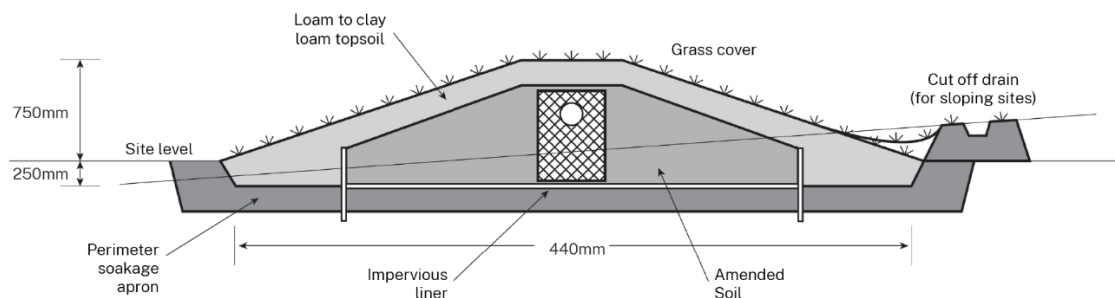

Figure 5-14: Typical Schematic of an Amended Soil Mound System

Adapted from *Designing and Installing On-site Wastewater Management Systems from WaterNSW (2023a)*

5.7 Onsite Effluent Application Options

Onsite effluent application involves applying effluent at a specific loading rate to vegetated land. This application can be above or below ground level and in existing or imported soil. The degree of wastewater treatment required for different effluent application systems is shown in Table 5-2.

To optimise performance, Effluent Application Areas (EAAs) should be located to maximise exposure to sun and wind.

Subsurface application is preferable because complete separation of humans and animals from all wastewater, regardless of whether it has been disinfected, is the best barrier to ensure public health protection.

Installation, operation and maintenance requirements for effluent application systems can be found in Appendix 4 and Appendix 5.

Effluent Application Summary

Effluent may be land applied onsite within an EAA system situated within the available EMA following treatment.

Effluent Management Area (EMA) refers to the area available within a site (i.e. the 'available EMA') for effluent application after applying the necessary setback distances and the exclusion of unsuitable areas.

Effluent Application Area (EAA) refers to the basal land area required for a system that distributes effluent into or onto the land for water and nutrient uptake, percolation, sorption and further biological polishing.

5.7.1 Absorption Systems (Trenches and Beds)

Absorption trench and bed systems are generally constructed below ground and can be media-filled or consist of a durable self-supporting arch resting on gravel or coarse sand. A distribution manifold is laid along the entire length of the trench or bed to deliver effluent evenly.

Distribution manifolds may be dosed by pressure, low-pressure or gravity arrangements. Pressure dosed systems ensure more even distribution and are preferred over gravity fed systems. Pressure dosed systems commonly utilise smaller diameter drilled pipe within a 100mm slotted pipe or ag pipe. Gravity fed systems, especially where constructed of large diameter slotted pipe alone, commonly result in uneven loading and in time suffer from creeping failure. Trenches and beds should not be fed by end of pipe flow into the trench or bed. It is important that the base of a trench or bed is laser levelled to ensure even distribution. A geotextile layer should be included over the gravel media and below a layer of vegetated topsoil.

Absorption systems rely on infiltration and percolation of effluent through an unsaturated aerobic soil profile to further polish effluent quality before recharging groundwater under the site. As effluent infiltrates the native soil profile, treatment occurs in the subsurface due to physio-chemical and biological processes as well as attenuation through dilution and dispersion.

Absorption trenches and beds provide in-soil storage due to the available volume in the void space within the media. This can provide the capacity for storage during higher flows or wet weather events.

Where effluent sits in the bottom of the trench or bed for a period of time, the conditions become anaerobic and a clogging layer develops. This reduces the hydraulic conductivity of the soil and slows the flow of effluent into the soil. It is important that trenches are constructed sufficiently above the water table or any low hydraulic conductivity layer for them to drain freely and for aerobic conditions to be restored as soon as possible.

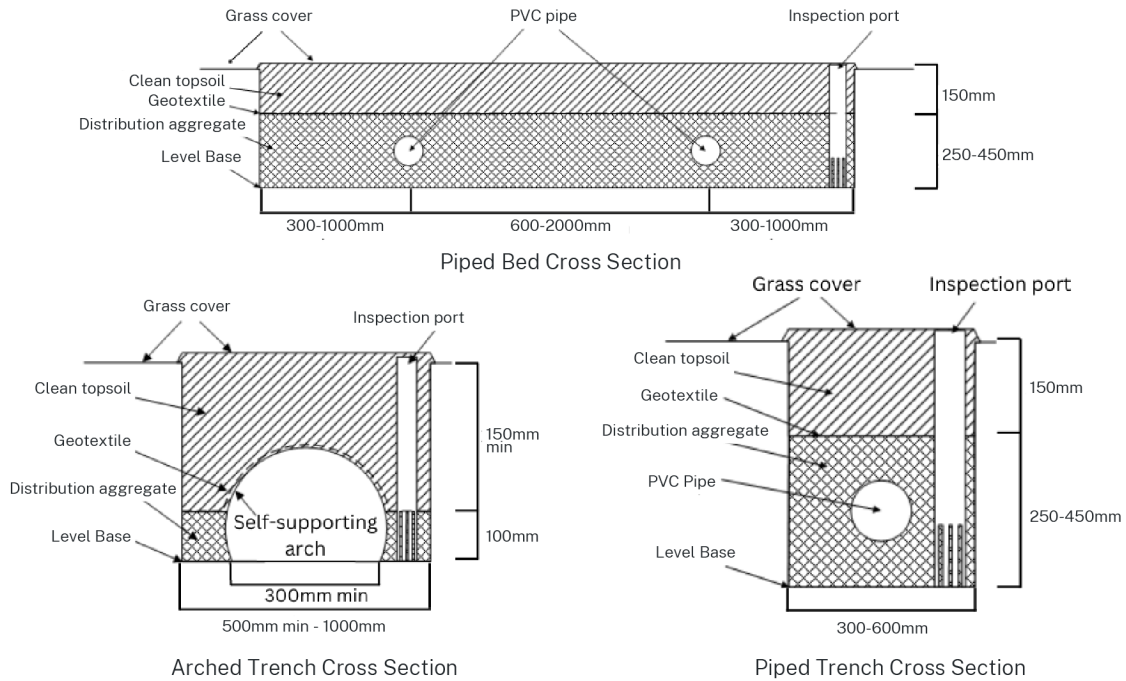

Figure 5-15: Typical Schematic of an Absorption System (Trench and Bed)

5.7.2 EvapoTranspiration Absorption (ETA) Systems

ETA trenches and beds rely on subsurface absorption as well as evaporation and transpiration by plants (evapotranspiration) to further polish effluent in the subsurface. As such, they perform best when installed in a position with good sun and wind exposure. ETA trenches and beds are generally constructed below ground or with a slightly mounded surface.

As effluent is dosed to the distribution manifold by either pressure, low-pressure or gravity, capillary action draws effluent up through the sand in the upper part of the ETA trench or bed from the storage in the void spaces in the gravel aggregate beneath. This supplies the root zone of the vegetation (usually grass) on the top of the trench or bed to optimise evapotranspiration. Effluent is distributed through the trench or bed by a system drilled pipes inside slotted pipes or ag pipe if the system is pressure dosed, or through large diameter slotted pipe alone if gravity fed, as with absorption trenches and beds.

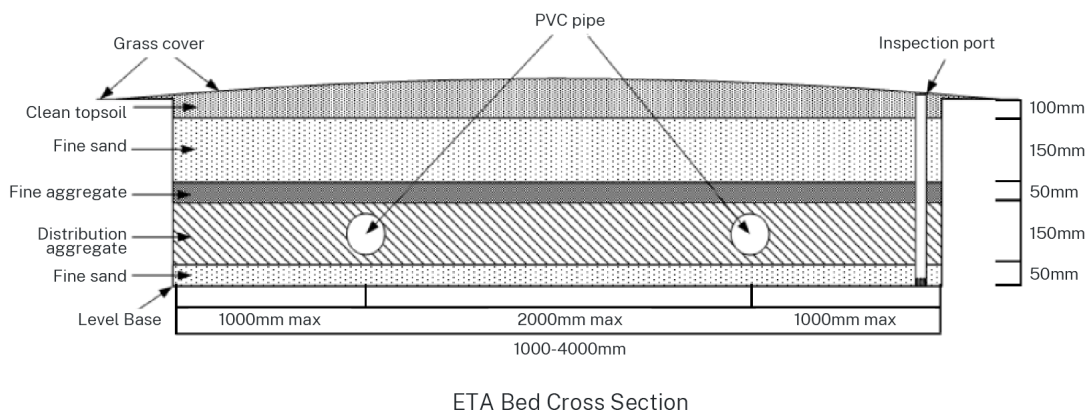

Figure 5-16: Typical Schematic of an ETA Bed

5.7.3 Wick (Trench and Bed) Systems

The wick trench and bed system is a series of trenches with adjacent evapotranspiration beds that are joined by a layer of geotextile. The evapotranspiration bed may be installed on either side of the trench. The surface of the combined wick bed, which is approximately three times the width of a conventional trench, is planted with herbaceous vegetation to maximise the wicking effect over the large surface area. The geotextile acts as the 'wick' to continuously draw liquid upwards from the trench through capillary action facilitated via vegetation, sun and wind.

The wick trench and bed must have uniform depth across the entire length. Trenches and beds must be constructed to provide an even depth of soil over the aggregate, which should also be level. Typically, the wick trench will be built with an evapotranspiration bed slightly less than twice the width of the trench. The trench is built using an arch trench that is a plastic self-supporting arch 410mm wide.

Distribution manifolds may be dosed by pressure, low-pressure or gravity arrangements as for absorption systems.

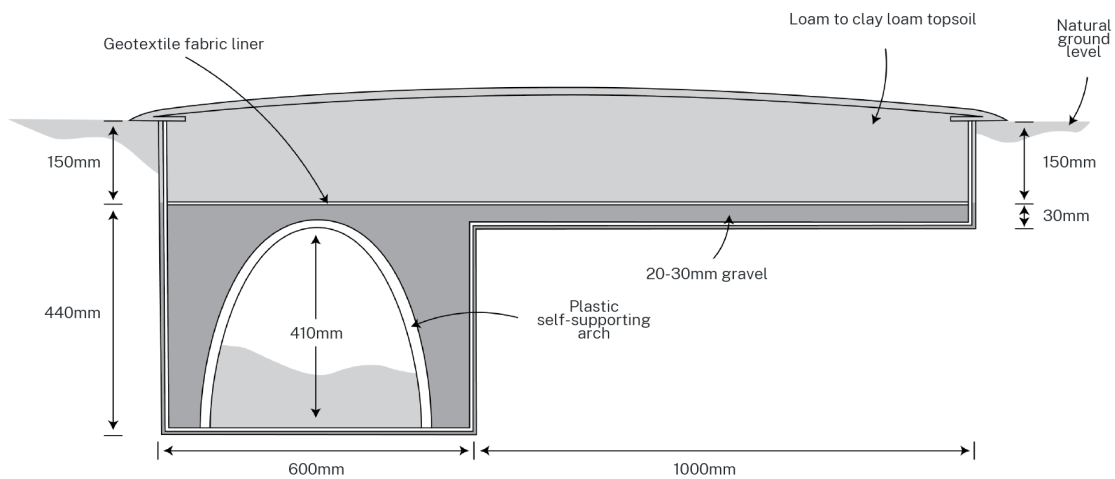

Figure 5-17: Typical Schematic of a Wick System

Adapted from *Designing and Installing On-site Wastewater Management Systems from WaterNSW (2023a)*

5.7.4 Low-Pressure Effluent Distribution (LPED) Irrigation Systems

LPED irrigation systems pressure dose primary or secondary treated effluent in shallow trenches (0.2m x 0.2m) within a pressure line perforated with drilled squirt holes and nestled in a distribution pipe.

LPED is not suitable for gravity distribution.

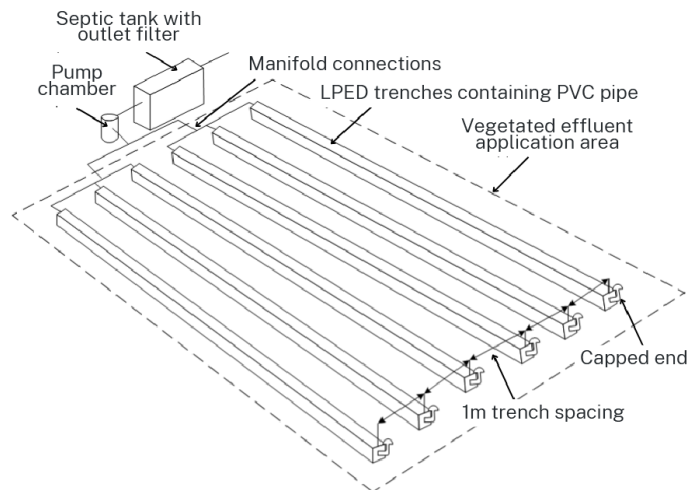

Figure 5-18: Typical Schematic of an LPED System

Amended after AS/NZS 1547:2012

5.7.5 Subsurface Irrigation Systems

SSI systems distribute effluent in the root zone of plants to maximise beneficial re-use of both the hydraulic and nutrient components of secondary treated effluent. The effluent is commonly disinfected. Irrigating effluent in the root zone of plants minimises the risk of human contact and reduces surface run-off during extended wet weather. SSI represents significantly lower risk of human contact and is preferred to SI.

SSI systems generally comprise polyethylene pipe fitted with Pressure-Compensating Drip Emitters (PCDE). The use of PCDE ensures even distribution can be achieved across the irrigation area and maintains low application rates across a variety of gradients and elevations when a SSI system is pressure dosed.

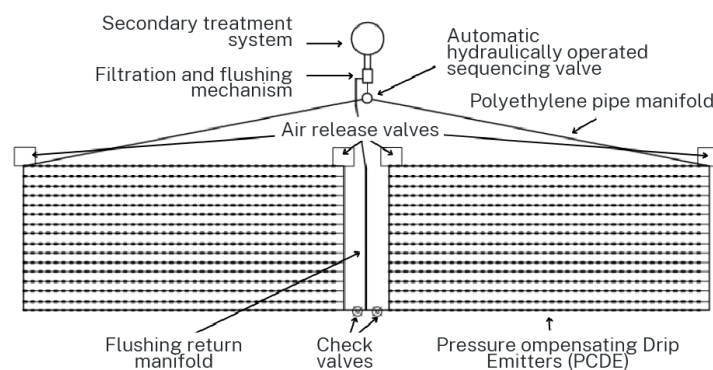

Figure 5-19: Typical Schematic of a Subsurface Irrigation System

5.7.6 Surface Irrigation Systems

SI systems involve the application of minimum secondary treated and disinfected effluent at the ground surface level by spray head sprinkler configurations. A wide variety of surface irrigation systems are available including rotary, impact, spray nozzle and dripper systems. Spray heads can be

fixed rise or pop-up sprinklers. Spray heads are required to make only a large droplet size to reduce the risk of spray drift.

As surface irrigation can result in human contact with effluent, it is important to recognise that risks are higher than with subsurface irrigation. Consequently, it is essential to maintain a high level of treatment system performance and disinfection and avoid human contact with effluent.

Covered surface drip irrigation involves applying effluent directly to the soil under a cover layer of mulch or other approved cover material, which is recommended to be held in place by a durable bird resistant mesh netting pinned securely to the ground surface.

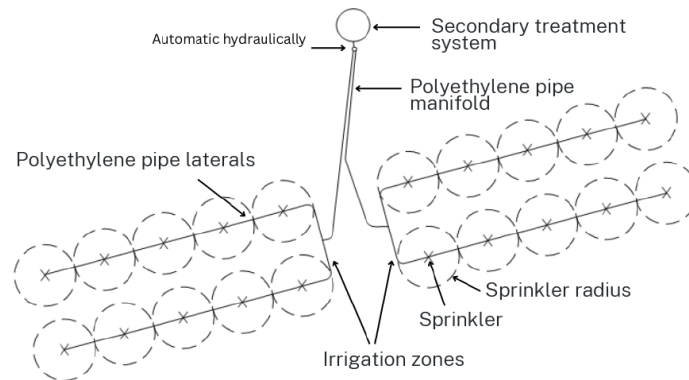

Figure 5-20: Typical Schematic of a Surface Irrigation System

5.7.7 Greywater Recycling Options (Level 1 and 2)

Level 1 and 2 greywater has additional recycling options in addition to subsurface irrigation of treated greywater, which is suitable for all GTS levels.

Outdoor recycling uses of greywater are permissible for greywater that has been treated to a Level 1 standard and include a hand-held hose for car washing and/or garden watering.

Indoor recycling uses of greywater are permissible for greywater that has been treated to a Level 1 or 2 standard and include toilet and urinal flushing. Greywater may only be recycled indoors for cold water supplies to automatic washing machines where it has been treated to a Level 1 standard.

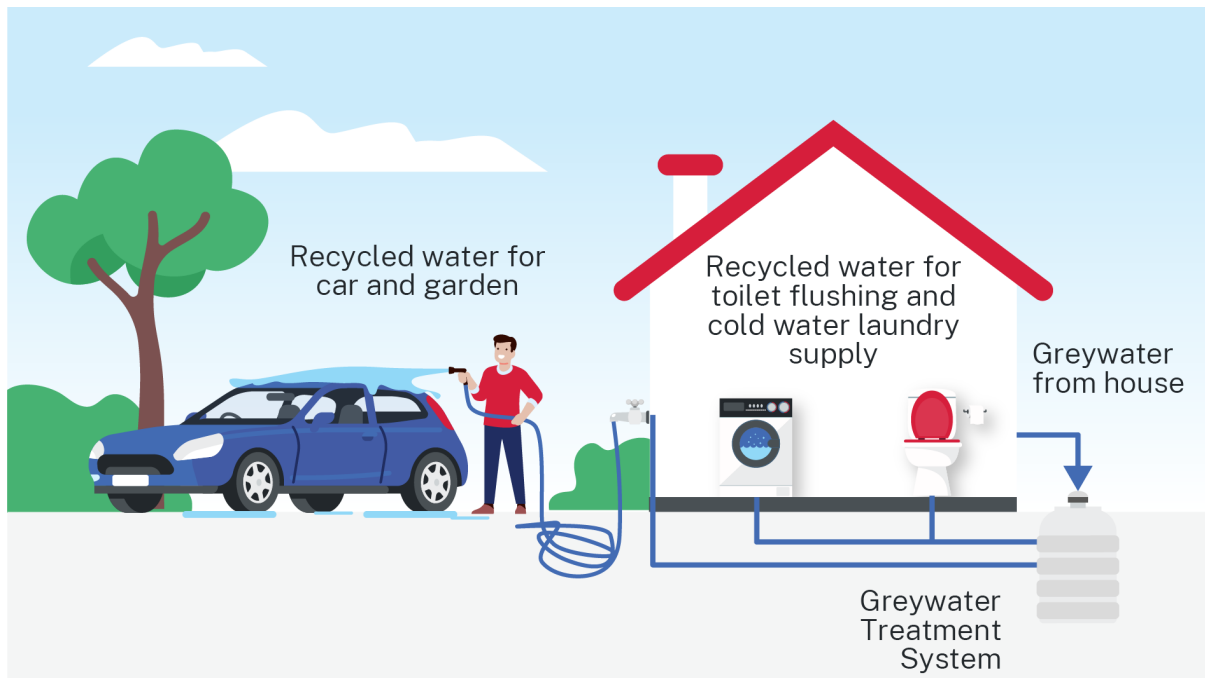

Figure 5-21: Typical Schematic of Level 1 Greywater Recycling Options

5.8 Partial Onsite Wastewater Management

Partial OWM may be necessary where sustainable onsite effluent application or reuse is only possible for part of the wastewater generated on the lot. The remaining effluent may be transferred off-site for further treatment and or reuse, for example to irrigate a sports oval or reserve. Alternatively, following initial onsite treatment, effluent may be transferred to a centralised wastewater management facility. This transfer is via a sanitary drainage system (in the case of a common effluent system), or by road transport (in the case of a pump-out system or chemical toilet).

5.8.1 Common Effluent Systems (CES)

A CES refers to the transfer of partially treated or macerated wastewater to a centralised wastewater management facility for additional management. CES arrangements remove the need for an onsite EAA as wastewaters receive preliminary treatment within an onsite treatment system and are collected and transported (by either gravity drainage, vacuum or pumping) through small diameter pipes to the centralised facility (i.e. 'pump to sewer'). Centralised wastewater management facilities can be managed by a local water utility or a private sector company providing water utility services under the *Water Industry Competition Act 2006* (WICA).

Minimum Performance Criteria

An appropriate pre-treatment device must be accredited by NSW Health. It can take the form of a Common Effluent Drainage System (CEDS), septic tank, an AWTS, a Sewage Ejection Pump Station (SEPS), or some other form of device. Council approval is needed to install a pre-treatment device. The designer should develop a plan of management for the CES to ensure that appropriate support infrastructure is available.

Accredited CEDS and SEPS can be found on the NSW Health 'Onsite single domestic wastewater management' website.

The owner or occupant is often responsible for the operation of the onsite component of the CES, and local councils must ensure that the overall CES is managed to ensure correct operation. Failure of a single onsite wastewater treatment system that is part of a CES may cause blockages in the sanitary drainage system and hence create nuisance to other users.

There are significant advantages in centralised professional ownership and management of CES to avoid reliance on individual homeowners.

In the design of a CES, the wastewater quality, quantity and flow rate characteristics must be considered. The owner/ operator of the CES must obtain approval under the LG Act or a WICA licence.

CES typically require a significant amount of professional maintenance. If a pumped CES is used, the power supply to the pump must not be turned off, or the pump allowed to pump dry, which is a critical risk for positive displacement pumps, which are commonly used. Leakage of glands and seals in the pump is also common and these should be repaired promptly.

5.8.2 Pump-out Systems

Pump-out systems involve treating wastewater generated onsite to a primary standard before displacing to a collection well with sufficient storage volume to allow for periodic collection by a licensed liquid waste contractor (i.e. by pump-out tanker truck).

Pump-Out System Summary

Pump-out systems may not be a viable long-term option due to potential misuse and abuse by occupants or system owners due to high costs.

Domestic pump-out systems should only be considered as a last resort, and only where existing OWMs are failing and a connection to sewer is not possible. New developments relying on a pump-out system should be considered an example of over-development of a site and not approved.

Local councils should consider ways of ensuring deliberate illegal discharges do not occur, by levying an annual charge or special rate for a pump-out service, regardless of pump-out frequency or quantity. The local council must have appropriate infrastructure in place to allow for the efficient monitoring and operation of pump-out schemes. Pump-out systems constitute a high health risk if inappropriate or inferior infrastructures for system management are provided.

Minimum Performance Criteria

Where primary treatment systems, such as septic tanks, are used in conjunction with a pump-out system, the same design, operation, installation and maintenance requirements apply.

All installations should be inspected before they are commissioned, and again at frequent intervals, to ensure that illegal diversions have not occurred. All occurrences of nil pump-outs should be investigated.

Collection Well Tanks

Collection wells used for effluent collection and storage must be accredited by NSW Health. Collection wells should be sized to contain a minimum of seven days plus two days additional storage for a weekly pump-out. Alternatively, collection wells can be sized for a longer time period to allow for different pump-out frequencies and scheduling.

Collection Well Capacity Summary

$$\text{Minimum Collection Well Capacity (L)} = \text{Daily Hydraulic Load (L/day)} \times 7\text{-days} + 2\text{-days emergency storage capacity}$$

The collection well should be fitted with a suitable alarm system, including a high water level alarm incorporating both audible (buzzer) and visual (strobe light or similar) components. The alarm should be automatically activated when the effluent content of the collection well exceeds the liquid level required to provide 48 hours of storage capacity. A muting facility should be incorporated into the audible alarm and shall reset to audible after 24 hours. The alarm panel should be located in a visible and accessible position.

On commercial or industrial sites, an information sign should be installed at the alarm location that provides contact names and telephone numbers should the alarm be observed to be activated. Telemetry technology (remote monitoring) of high water level alarms should also be considered.

Standpipe, Draw-off Lines and Fittings

Draw-off lines should be constructed of minimum 50mm Class 9 PVC pipe that conforms to the relevant Australian Standard. The draw-off line, which terminates at the property boundary where a gate valve is fitted, should be buried below ground to protect the pipework from UV and physical damage.

Standpipes should be constructed of a suitable material resistant to damage by UV and physical damage. Suitable materials may include corrosion resistant metals such as galvanised metal. The standpipe should be securely supported in a position inside the property boundary. A suitable connector for tanker connection should be fitted to the end of the standpipe and must include an end-cap. A suitable fitting may include a screw on adaptor or cam-lock. A shut-off or stop valve shall be fitted where the height of the standpipe outlet is physically lower than the lid of the collection well. The standpipe should be located in a position that permits the safe parking of the effluent removal tanker.

Sufficient and appropriate access and standing area should be provided for the pump-out vehicle; as a general rule a tanker truck requires approximately a 5m wide access road.

In extreme cases, and if there are adverse site contours, it might be necessary to install an additional collection well below the septic tank. This well pumps the effluent to another collection well near the property boundary. Alternatively, pumps may be installed at the collection well to boost pressure to help the suction pump on the tanker. Pumps might require three-phase electrical wiring and a dedicated electrical service.

5.9 Emerging Onsite Wastewater Management Systems

Technologies used in onsite wastewater management are constantly being updated in accordance with scientific development. New and emerging technologies may include but are not limited to biogas digesters.

At the date of publication there are no accredited biogas digestors. For any design recommending a biogas digester it is recommended that the designer contact the relevant local council for approval advice. Further advice may be available on the NSW Health website in regards to use and accreditation of any systems. Caution is recommended in regards to gas safety regulations and the impact of the biogas digester on any system components with NSW Health accreditation as it may impact compliance with the conditions of accreditation. Where effluent is produced by a biogas digester system it should be managed in accordance with this Guideline, AS/NZS 1547:2012 and local council policy.

Draft

Section 6: Onsite Wastewater Management System Design



Section 6. Onsite Wastewater Management System Design

6.1 Wastewater Generation

Wastewater generation is calculated as the daily hydraulic load (L/day) for wastewater produced by a development based on the design occupancy and flow allowance relevant to the development. Local water authorities may have their own requirements for wastewater generation calculations. Always check the requirements of the local water authority when designing in a drinking water catchment.

Wastewater Generation Summary

$$\text{Daily Hydraulic Load (L/day)} = \text{Design Occupancy (EP)} \times \text{Design Flow Allowance (L/person/day)}$$

Design occupancy in domestic settings can be defined as the maximum potential future occupancy of a household based on the number of bedrooms (i.e. the 'Equivalent Persons' (EP), and is not the number of people living or intending to live in a household, unless that number will be higher than the design occupancy. Design occupancy in commercial settings may refer to the maximum total number of staff, visitors, or guests intended to occupy a development on any given day.

Design flow allowances can be defined as the daily water use of a development per EP (L/person/day) that will be converted to wastewater.

Table 6-1: Design Occupancy

Number of Bedrooms in Household	Design Occupancy (EP)
1	3
2	4
3	5
4	6
5	7
6	8
7	9
8	10

NOTES

- A design occupancy rate of 3EP in the 1st bedroom with 1EP for each bedroom thereafter is considered a conservative approach to the calculation of EP for a household, where the local council and/ or local water authority has not specified otherwise.
- Bedrooms are defined as any room that possesses the potential to be used as a bedroom in the future. Generally, any room that contains a door and windows is considered a potential bedroom and includes rooms such as studies, games/ media rooms, home gyms and studios. It is up to the discretion of the local council to determine whether or not a room is considered a bedroom for design purposes.

- Tiny houses (and similar developments) should be considered as a 1-bedroom development with designs based on 3EP (unless they contain two or more bedrooms).
- Short-term accommodation occupancy should be based on available beds.

Table 6-2: Design Flow Allowances

Residential households with standard water fixtures	Design Flow Allowance (L/person/day)	
	Onsite (tank) water supply	Reticulated or bore water supply
Wastewater	120	150
Greywater	80	100
Blackwater	40	50

NOTES

- Deviations from the flow allowances in Table 6-2 should only be accepted where evidence supports their use. That is, either specific water usage data recorded by a flow/ water meter or data presented in reputable scientific literature can be demonstrated as appropriate. Note, WaterNSW specifications are to be followed within the Sydney Drinking Water Catchment.
- Standard water fixtures include water closet, hand basins, kitchen sink, dishwasher, shower, bath and laundry tub and washing machines.
- Non-standard water fixtures include spa baths and kitchen food-waste grinders or other fixtures that generate significantly more water than standard household fixtures. They are not recommended to be installed in unsewered areas. Where they are included, flow allowances should be adjusted based on the specific capacity of the spa bath or waste application unit as per the manufacturer and the intended usage pattern.
- Short-term accommodation flow allowances should be based on a reticulated water supply.

6.1.1 Intermittent and Surge Flows

Intermittent occupancy of developments containing OWMs may result in an irregular pattern of wastewater being delivered to a treatment system and/ or effluent application system. Common development scenarios that may be occupied intermittently include holiday homes, schools, sportsgrounds, recreational grounds and short-term accommodation units such as cabins, hotels, motels, camping grounds and holiday parks.

In periods of minimal occupancy and low or no flows, treatment systems can become under-loaded, which in turn reduces the treatment performance of certain treatment systems. For example, AWTS and WCS require a regular inflow of wastewater to sustain microorganism and worm populations that facilitate treatment processes. Some systems can be set up to cope with intermittent occupancy.

In periods of high occupancy and surge flows, treatment systems can become overloaded which can reduce the HRT required to meet effluent quality standards and potentially force untreated solids through the treatment plant and into the EAA.

Minimum Performance Criteria

Where a design is proposed that may be subject to intermittent or surge flows, the design report should address the range of occupancy scenarios and associated daily hydraulic loads and design for the peak daily hydraulic load. Treatment system selection should be based on systems that can cope with intermittent loading such as septic tanks and Aerobic Sand and Media Filter (ASMFS) systems. Some commercial AWTS systems that include a recirculation option controlled by a low-flow switch may be suitable. Where sufficient peak flow storage is not available in the designed treatment unit and EAAs, balance tank designs may be appropriate.

Balance Tanks

Balance tanks operate as storage facilities that allow for peak flows to be captured during peak usage events, stored and incrementally fed to the treatment system and/ or EAA during periods of low or no usage. The capacity of a balance tank should be verified by calculations that demonstrate sufficient storage is available between peak usage events. All balance tank designs should address the details for how surge flows will be captured during peak usage events and be moderated through periods of low or no flows. Balance tank designs need to demonstrate how timed loads are transferred at an appropriate rate to maintain treatment system processes and ensure appropriate and even distribution to the EAA.

6.2 System-Specific Design Considerations

6.2.1 Septic Tanks

Septic tank capacities should be sized to hold the peak daily hydraulic load for at least 24 hours at 200L/person/day plus an allowance for accumulated sludge at 80L/person/year as per AS/NZS 1546.1. For domestic scale dwellings, appropriate septic tank capacities can be taken from Table 6-3 based on the design occupancy and a five year pump out cycle.

A septic tank of a larger capacity than the nominated minimum capacities in Table 6-3 will have a longer retention period, which will result in improved effluent quality. Larger capacity tanks may also be more economical to purchase due to higher production numbers.

If additional wastewater generating facilities such as a spa are installed in a dwelling, the capacity of the septic tank would need to be increased to account for the additional flows within a 24-hour period, i.e. a 300L spa would require the capacity of the septic tank to increase by at least 300L greater than the tank required for that size dwelling.

It is not recommended that food waste grinders or digesters are used for sites on an OWMS as these will increase solids production (Bounds 1988) and will increase wastewater production too, where water is introduced into the grinder or digester.

Table 6-3: Minimum Operational Septic Tank Capacity

Design Occupancy (EP)	Minimum Septic Tank Capacity (L)
3	1,800
4	2,400
5	3,000
6	3,600
7	4,200
8	4,800
9	5,400
10	6,000

6.2.2 Waterless Composting Toilet Systems

WCT system designs must cater for leachate generation. Leachate generation can be calculated from the urine component of wastewater at 1.3L/person/day as per Appendix E of AS/NZS 1546.2:2008. The leachate can be directed to the greywater treatment (and application) system provided the leachate volume has been accounted for in the daily hydraulic load (L/day). Alternatively, leachate can be disposed of in a small absorption EAA following the WCT system. Some commercial sized WCT systems may have a leachate re-circulation option to promote further evaporation.

Consideration should be given to non-residential uses of WCT systems, such as public toilets, where larger composting chambers or urine-separators may be required. Refer to Appendix E in AS/NZS 1546.2:2008 for design guidance in these scenarios.

6.2.3 Aerobic Sand and Media Filter Systems

Site specific designs for single pass sand filter systems involve the calculation of the surface area required based on the most limiting hydraulic and organic loading rates for the development based on a depth of 600mm of filter sand below the point of application (Siegrist 2017). For primary treated effluent, the hydraulic loading rate should not exceed 50L/m²/day and the organic load (BOD₅) should not exceed 25g/m²/day with dosing typically 12-24 times per day. For recirculating gravel filters, the filtrate typically passes through the filter 3-5 times. Hydraulic loading rates should not exceed 200L/m²/day with dosing typically 48-72 times per day. For fabric filters hydraulic loading rates may be up to 1,000L/m²/day with dosing up to 96 times/day. Designers should specify an appropriate length: width (L:W) construction ratio where appropriate L:W ranges between 2:1 and 10:1.

See Appendix 6 for a worked example.

6.2.4 Constructed Wetlands

Site-specific designs for constructed wetlands should calculate the volume required for a minimum HRT of 5 days to achieve secondary treatment of primary effluent (NIWA 2011).

Constructed Wetland Volume Calculation

$$Volume (V) = (rt \times Q) / p_{(gravel)}$$

Where:

(V) = Wetland Volume (L)

(rt) = Residence Time (days)

(Q) = Daily Hydraulic Load (L)

(p_(gravel)) = Porosity of Gravel

Designers should specify an appropriate length: width (L:W) construction ratio where appropriate L:W ranges between 4:1 and 1:1. Optimal depth of wetland systems should not exceed 0.6-0.7m wetted depth under 100mm of aggregate based on typical root depth of plant species used. Designers should specify container manufacturer details and ensure final sizing aligns with specified container details.

Where multiple constructed wetland containers are used, individual containers may be linked in series and 1m apart to achieve the desired volume necessary to meet the HRT. Where this makes the L:W too high, parallel runs of containers joined in series can be used, with an appropriate distribution device used to evenly split effluent between the parallel runs. An equal number of containers should

be present in each run, or the effluent distributed proportionally to the run size using a suitable distribution device.

Appropriate macrophyte plant species should be planted at a (minimum) density of four plants per square metre of wetland.

See Appendix 6 for a worked example.

6.2.5 Greywater Treatment Systems

A connection to the sewer, if available, or a suitably designed and sized OWMS is required for the operation and maintenance of some GTS. This will need to be taken into account for the design of the GTS and blackwater OWMS on non-sewered sites.

The design of the GTS reuse or irrigation system must take into account that not all treated greywater may be reused in the dwelling, requiring that the additional volume must be accounted for in a suitably designed and sized greywater EAA or within the capacity of the blackwater EAA. Treated greywater irrigation design should be in accordance with secondary treated effluent procedures and AS/NZS 1547:2012.

6.2.6 Absorption, ETA and Wick Systems (Trenches and Beds)

All absorption and ETA trench and bed dimensions should conform to Table L2 of AS/NZS 1547:2012. All ETA trenches and beds should be designed using water balance modelling to ensure optimum bed size and an appropriate volume of storage in the gravel bed. It is best practice to use a water balance for absorption systems too.

Linear loading rates should be considered where the SSE has demonstrated shallow soil limitations or sloping sites.

Non-conventional absorption and ETA trench or bed designs, such as raised absorption systems, may be suitable in settings where a shallow limiting layer has been identified and the required separation is not met.

Individual trench or bed length should be no greater than 20m unless even distribution can be provided by pressure dosing. Distribution along trench and bed lengths is via slotted or drilled distribution line of at least 80mm internal diameter.

Where multiple trench or bed configurations are proposed, mechanisms that distribute effluent evenly across each trench or bed should be included. This may include proportional dosing using a distribution box or sequencing valve. See Section 6.6 on distribution. Typically, individual trenches or beds should be equal sizes, although can be different dimensions provided even application is ensured.

6.2.7 Wick (Trench and Bed) Systems

The required total length of the wick trench can be calculated using the daily hydraulic load (L/day) and the DLR for absorption systems and ETA beds in AS/NZS 1547:2012. All Wick systems should be designed using hydraulic balance modelling to ensure optimum trench and bed size.

Wick systems are suitable for flat areas only, where the available land is not flat, these systems should be terraced to provide a flat platform, provided the soil depth is sufficient.

Where multiple trench or bed configurations are proposed, mechanisms that distribute effluent evenly across each trench or bed should be included. See Section 6.6 on distribution.

6.2.8 Low-Pressure Effluent Distribution (LPED) Systems

All LPED systems require a minimum depth of 0.25m of Category 1-4 topsoil. Where dosed with primary treated effluent, the septic tank should be fitted with an outlet filter. All LPED systems must be pressure or low-pressure dosed. Pressure dosing of primary treated effluent should be achieved via a pump well/ dosing tank fitted with a (vortex-type) submersible pump suitable for use with primary effluent (where applicable) or with a low pressure dosing device.

6.2.9 Mounds

Mound systems are best suited to level sites. On sloping sites, the mound should be designed and built along the contour of the land and with the width of the toe increasing with slope. Consideration of Linear Loading Rate (LLR) is imperative in mound design. Outlet filters on primary treatment systems are recommended to reduce solids carryover into the sand-fill media and prevent clogging of filter material. Distribution manifolds must be supplied by pressure or low-pressure dosing methods. Dosing manifolds must be dosed with small volumes of effluent often, rather than with larger volumes less often, to minimise the risk of toe seepage. Timed dosing of small volumes of effluent over the entire day is best practice. Further guidance on mound design and construction can be found in Converse and Tyler (2000).

6.2.10 Subsurface Irrigation

SSI systems may need to be split into zones supplied via a distribution or hydraulic sequencing valve with each zone $\leq 400\text{m}^2$ (typically 250-300 m^2). Zones allow the cycling of areas in use, reducing the risk of pooling effluent and reducing the load on the irrigation pump.

Systems should be designed to deliver an appropriate dosing volume that fully charges the irrigation lines in each zone. Pump selection must overcome the friction loss and head loss in the system and meet the required head and irrigation flow rates of the selected emitters at the most distant point in the system. Incorporate air/ vacuum valves, pressure-reducing valves and non-return/ tube non-leakage valves into the design as needed. Systems should incorporate flush valves correctly located for periodic cleaning of the PSCD lines as part of system maintenance to avoid blockages.

Additional hydraulic design will be needed where the SSI area slopes exceed 10% or the area is a long distance from or upslope of the treatment system. For example, the design may need a higher head pump to evenly distribute the effluent throughout the SSI area due to the increased head required to overcome friction losses or static head losses. DIR reductions as shown in Table M2 of the AS/NZS 1547:2012 should be followed for steep slopes.

Appropriate signage should indicate that effluent is being irrigated at all access points to the irrigation area.

6.2.11 Surface Irrigation

Surface irrigation systems may need to be split into zones supplied via a hydraulic sequencing valve with each zone $\leq 400\text{m}^2$ (typically 250-300 m^2). Zones allow the cycling of areas in use, reducing the risk of pooling effluent and reducing the load on the irrigation pump.

The use of moveable sprinklers and soaker hoses is not recommended due to the risk of misuse and hose kinking. Sprays must not generate aerosols. Sprinkler heads that produce a large droplet size are the least likely to generate spray drift.

Local climate is a consideration in design as SI systems are not suitable in high rainfall areas, where the ground remains saturated for long periods of time, due to the increased risk of human contact with effluent and surface runoff.

Flood irrigation and open pipe (end of pipe) distribution are not permitted as surface irrigation options.

Irrigation areas can be either landscaped garden beds or lawn areas. The irrigation area should be planted with species appropriate for effluent irrigation. Appropriate signage should indicate that effluent is being irrigated at all access points to the irrigation area.

6.3 Onsite Effluent Application Area Sizing

Designing and sizing an EAA system considers the critical loading rates of hydraulics and nutrients at the infiltrative surface of an EAA, which have been found to be the limiting factors controlling EAA size. Example calculations for sizing methods are provided in Appendix 6.

6.3.1 Design Loading Rates and Design Irrigation Rates

The Design Loading Rate (DLR) and Design Irrigation Rate (DIR) are determined on the basis of the textural class of the soil which has the lowest hydraulic conductivity (permeability) within the zone of influence, which is 0.6 metre beneath the point of application. DLRs and DIRs are outlined in Tables L1, M1, N1 of AS/NZS 1547:2012 for sizing trenches and beds, irrigation systems and mounds and adapted in Table 6-4

DLRs assume there is no hydraulically limiting layer beneath the base of the EAA. Where there is a limiting layer, the linear loading rate should be used as it is designed to ensure that the effluent cannot return to the surface as it travels downslope due to the presence of a hydraulically limiting layer (WaterNSW 2023a). See Section 6.3.5.

The sizing of mounds is based on the DLRs in Table N1 of AS/NZS 1547:2012. The LLR is used to determine aggregate bed width within the mound. In addition to this, on steeper slopes it is important to incorporate a sufficient downslope toe.

Table 6-4: Design Loading/ Irrigation Rates (DLR/ DIR) for Effluent Application Systems

Soil Category	Soil Texture	Soil Structure	Indicative Permeability (K_{sat}) (m/day)	Design Loading/ Irrigation Rate (DLR/ DIR) (mm/day) ¹						
				Trenches And Beds			ETA/ ETS Beds and Trenches	Drip and Spray Irrigation	LPED Irrigation	Mounds (Basal Area)
				Primary treated effluent		Secondary Treated Effluent Rate				
				Conservative Rate	Maximum Rate					
1	Gravels and sands	Massive	> 3.0	20 ²	35 ²	50 ²	ETA systems are not suitable in Category 1, 2 and 3 soils	5 ⁵	Note 7	32
2	Sandy loams	Weak/ Massive	> 3.0	20 ²	30 ²	50 ²			4	24
			1.4 – 3.0	15	25	50				
3	Loams	Strong/ Moderate	1.5 – 3.0	15	25	50	4 ⁶	3.5	24	
		Weak/ Massive	0.5 – 1.5	10	15	30			16	
4	Clay loams	Strong/ Moderate	0.5 – 1.5	10	15	30	12	3.5 ⁶	3	16
		Weak	0.12 – 0.5	6	10	20				8
		Massive	0.06 – 0.12	4	5	10				5
5	Light clays	Strong	0.12 – 0.5	5	8	12	8	3 ⁶	2.5 ⁸	8
		Moderate	0.06 – 0.12		5	10				5 ^{3,4}
		Weak	< 0.06		Note 4	8				

Soil Category	Soil Texture	Soil Structure	Indicative Permeability (K_{sat}) (m/day)	Design Loading/ Irrigation Rate (DLR/ DIR) (mm/day) ¹										
				Trenches And Beds				ETA/ ETS Beds and Trenches	Drip and Spray Irrigation	LPED Irrigation	Mounds (Basal Area)			
				Primary treated effluent		Secondary Treated Effluent Rate								
				Conservative Rate	Maximum Rate									
6	Medium to heavy clays	Strong	0.06 – 05											
		Moderate	< 0.06						2 ⁵	Note 7				
		Weak	< 0.06											

NOTES:

- Adapted from AS/NZS 1547:2012
- EAA systems in these soils require design by suitably qualified and experienced personnel and should ensure even distribution across the entire EAA to account for the low nutrient retention capacity of these soils.
- To enable use of such soils for EAA systems, the design should ensure even distribution, typically by pressure dosing, and be sized on a full water balance. Soil permeability testing can be used to confirm soil category for determination of a loading rate. Specialist soils advice and special design techniques will be required for clay dominated soils having dispersive (sodic) or shrink/ swell behaviour. Such soils shall be treated as Category 6 soils. In most situations, the design will need to rely on more processes than just absorption by the soil.
- For category 6 soils ETA systems are suitable only for use with secondary treated effluent.
- For Category 1, 2, and 6 soils, the drip irrigation system has a depth of 100 - 150 mm in good quality topsoil.
- For Category 3 to 5 soils (loams to light clays), the drip irrigation system needs to be installed in an adequate depth of topsoil (in the order of 150 - 250 mm of in situ or imported good quality topsoil) to slow the soakage and assist with nutrient reduction.
- LPED irrigation is not advised for Category 1 or Category 6 soils - drip irrigation of secondary effluent is the preferred irrigation method.
- LPED irrigation for Category 5 soils needs a minimum depth of 250 mm of good quality topsoil.

6.3.2 Areal Calculation Method

Best practice for sizing all EAA systems is to use a water balance. The areal calculation method is only suitable for use on sites with no climatic constraints, such as high rainfall or periods of the year where rainfall exceeds evaporation. The areal calculation method is outlined in AS/NZS 1547:2012 for sizing absorption systems and is a simplified approach to sizing the required EAA based on hydraulics alone with no climate inputs.

Areal Calculation Summary

$$A = Q / (\text{DLR or DIR})$$

Where:

(A) = Area (m²)

(Q) = Daily Hydraulic Load (L/day)

(DLR or DIR) = Design Loading Rate or Design Irrigation Rate (mm/day)

Where trench or bed length needs to be determined

$$L = A / W$$

Where:

(A) = Area (m²)

(W) = Width (m)

6.3.3 Water Balance Modelling

The purpose of a water balance is to model natural water cycle processes using local climate data and applied effluent to determine the minimum EAA required to sustainably assimilate effluent within the soil profile and vegetation.

Processes that result in a gain of water including precipitation and effluent applied to a soil profile are considered the model 'inputs'. Processes that result in a loss of water including evapotranspiration by vegetation and vertical percolation of water down a soil profile are considered the model 'outputs'. The capacity for water to be stored within the subsoil EAA system is represented as the 'storage'. Storage for irrigation systems and highly permeable soils (Category 1 and 2) should be zero. Figure 6-1 demonstrates the water cycle processes in an effluent application water balance.

Spreadsheets are the most straightforward and efficient method of water balance modelling. Water balance models are limited by the estimates made to approximate natural processes, and they are not intended to be exact replications of real site conditions.

Water balance modelling can be based on monthly or daily climate data. Monthly water balances are more conservative and relatively simple. Daily water balances are less conservative, but more representative of actual conditions. In the event of extreme weather conditions, monthly water balances result in system sizing with a lower risk of failure.

Effluent Application Water Balance

$$\text{Precipitation} + \text{Applied Effluent} = \text{Evapotranspiration} + \text{Infiltration} + \text{Storage}$$

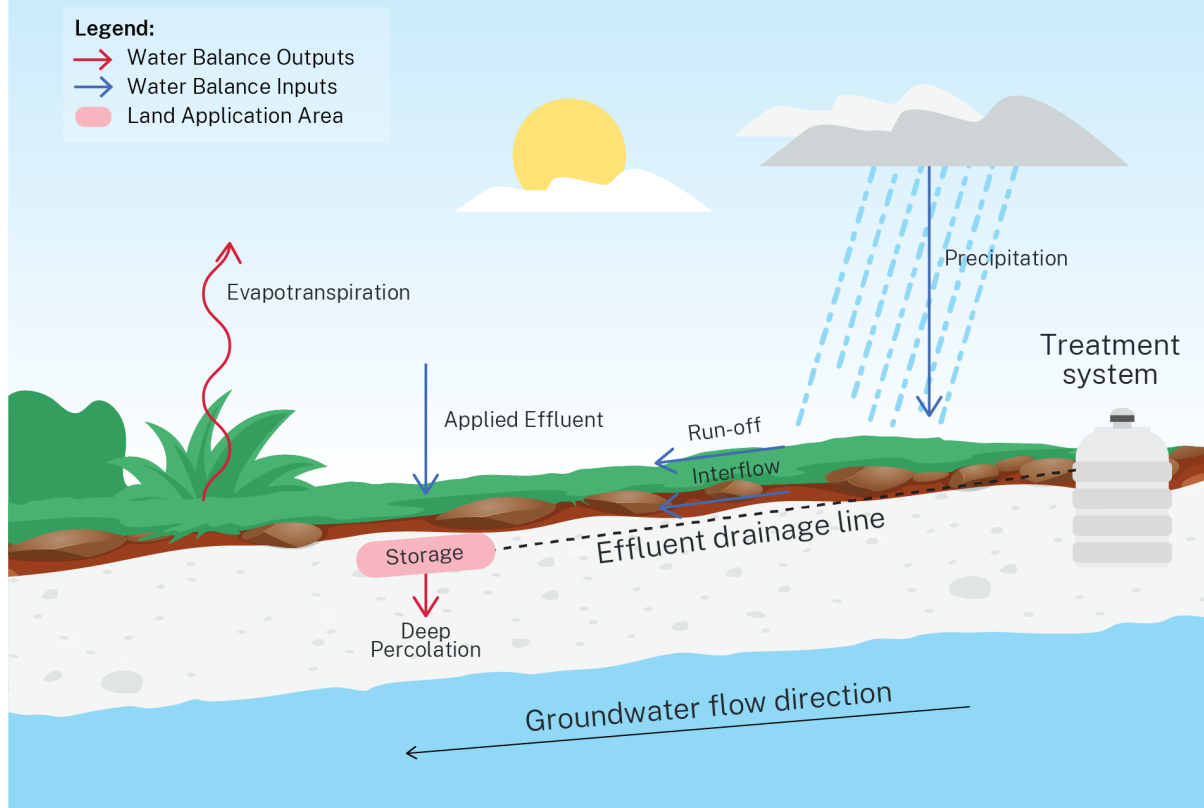

Figure 6-1: Effluent Application Water Balance

Wet Weather Storage

In a sustainable system long-term 'storage' should be zero. However, some EAA systems have a capacity for in-soil 'wet weather storage', such as absorption ETA trenches and beds. These systems have the capacity to hold excess water in the sand and/ or gravel matrix for assimilation in subsequent lower flow or drier periods. Wet weather storage represents the amount of effluent that can be safely stored within a trench or bed EAA system during the most limiting climate months of the year and can be calculated in a water balance.

Irrigation systems do not contain a capacity for in-soil storage compared to trench or bed systems. Wet weather storage for irrigation systems is only recommended on highly constrained sites where available EMA is limited and rely on use of storage tanks and balancing management. In these cases, secondary treatment, SSI, storage tanks and a control system are recommended to ensure the risk of effluent run-off is minimised. Where these designs are proposed, an irrigation plan should be prepared by a suitable wastewater consultant that details:

- Calculations of the required capacity of wet weather storage, taken from the water balance;
- The installation of a control system incorporating rainfall and soil saturation sensors and irrigation timer to control pump cycle times to effectively utilise wet weather storage capacity;
- Procedures for management including irrigation scheduling (timing and duration of irrigation, permissible daily application rates, monitoring of site and soil conditions (including rain gauge/ sensor control system), recording of irrigation rates, and vegetation cutting, pruning or harvesting regimes);

- Mitigation measures required to overcome site specific constraints, such as localised stormwater run-on or runoff problems;
- Inspection regime including the periodic inspection of the EAA to check SSI condition, effective distribution and for overloading and soil saturation; and
- The installation of a visual and audible high water level alarm within the storage tank set to alarm when capacity reaches ~70% to provide sufficient lead time to arrange a pump-out by a licensed liquid waste contractor in the event of a prolonged rainfall period.

6.3.4 Nutrient Balance Modelling

The purpose of a nutrient balance is to model natural nutrient (N and P) cycles and processes to determine the minimum application area required to sustainably assimilate nutrients within the soil and vegetation.

Effluent application systems rely on natural N and P cycle processes that control the fate and transport of nutrients in the environment. The nutrient balance models the proportion of the N and P cycle processes that occur within the subsoil-water-atmosphere interface for a specific soil and accounts for the amount of nutrients within applied effluent that is being added to a soil profile.

Once land applied, both N and P are assimilated by plants ('plant uptake'). P is further removed by soil P sorption processes that bind the nutrient to soil particles. The capacity of a soil to sorb P is site-specific and laboratory testing is generally recommended. Where site specific laboratory test data or published P-sorption data for the relevant soil landscape are not available, data from Table 4-7 may be used, as long as site specific data on soil texture and structure are available. The maximum soil depth for P sorption determination in a nutrient balance is 1 metre or the depth to the limiting layer or depth of investigation below the effluent application point, whichever is smaller.

N is further removed by processes of ammonification, denitrification, microbial digestion and volatilisation ('N cycle processes') which are responsible for removing up to 40% of land applied N (Geary and Gardener 1996). Appendix S of AS/NZS 1547:2012 provides further information on nutrient processes. Figure 6-2 demonstrates the nutrient cycle processes in an effluent application water balance.

Nutrient assimilation is particularly important on environmentally sensitive sites.

Effluent Application Nutrient Balance

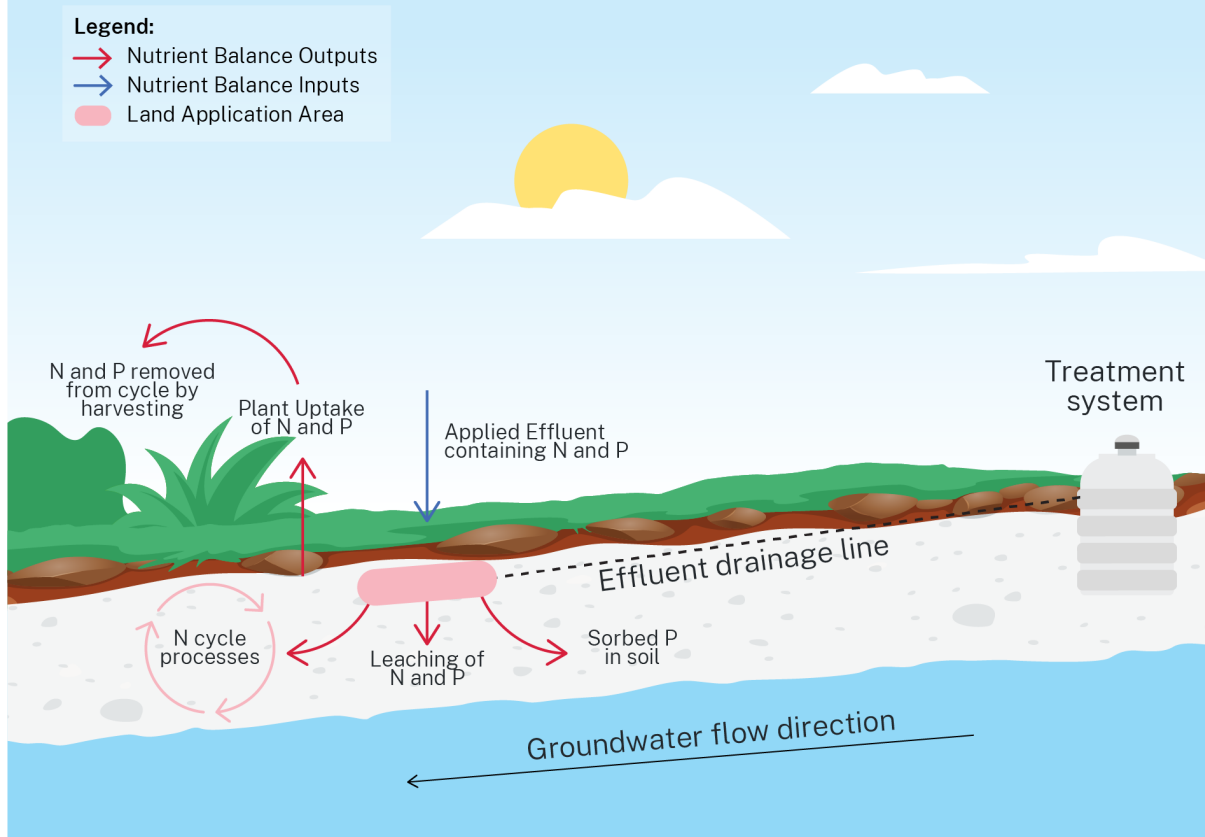

Figure 6-2: Effluent Application Nutrient Balance

Nutrient Uptake Areas

Several studies (Beggs et al. 2010; Cote et al. 2003; and Hassan et al. 2008) have modelled the fate of nutrients under an EAA system in the underlying soil profile. Research suggests where effluent remains subsurface, nutrients are transported in a subsurface plume, the nature and extent of which is dependent on the level of treatment, subsurface conditions and the constituent attenuation and assimilation under and away from the location of infiltration (i.e. the subsoil EAA system).

A Nutrient Uptake Area (NUA) is the area set aside around the surrounding and downslope area of an EAA system that allows for further nutrient reduction to background levels before reaching any sensitive receptors. NUAs should not be located within buffers to ensure nutrients are sustainably assimilated before reaching sensitive receptors or property boundaries (WaterNSW 2023a). Vegetation cover should be maintained on NUAs at all times and NUAs should be protected from future development.

Nutrient Uptake Area Summary

$$\text{Nutrient Uptake Area (NUA)} = \text{Nutrient Balance Area Requirement} - \text{Hydraulic Area Requirement}$$

NUAs are useful for effluent application systems where the hydraulic area requirement is less than the nutrient balance area requirement, such as absorption systems and ETA beds where nutrient uptake has previously not been considered a traditional component of design. The trench/ bed layout of these systems can be sized on the hydraulic component, while the results of the nutrient balance

model identifies the required area to be set aside in the surrounding downslope area of the EAA to further assimilate nutrients.

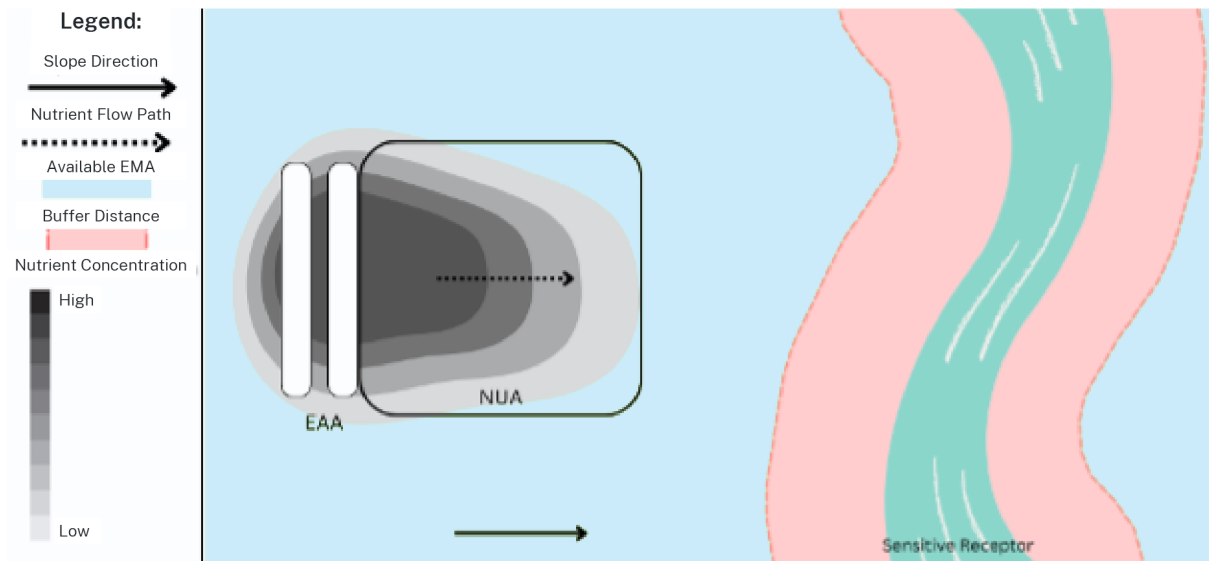

Figure 6-3: Plan View Schematic of the Fate and Transport of Nutrients Under an EAA

6.3.5 Alternative Modelling Techniques

Other modelling techniques are available using proprietary modelling tools, e.g. MEDLI. Where other models are used, peer reviewed scientific evidence must support their use.

6.4 Linear Loading Rate

The hydraulic Linear Loading Rate (LLR) is the amount of effluent that the soil around an effluent infiltration system can carry far enough away from the infiltration surface for it to no longer influence the infiltration of additional effluent (Tyler 2001). LLRs must be used in conjunction with DLRs from AS/NZS 1547:2012. The DLR assumes no hydraulically limiting layer exists beneath the base of the effluent application area (e.g. shallow bedrock or groundwater) and vertical movement of effluent is unrestricted.

In comparison, the LLR accounts for the presence of a limiting layer to ensure no effluent can return to the surface as it travels downslope given vertical movement beneath the EAA is restricted. (WaterNSW 2023a). LLRs take into consideration slope, depth to limiting layer and soil texture and structure. To ensure that the hydraulic capacity of the soil is not exceeded and toe seepage beneath effluent application systems is avoided, DLRs should not exceed LLRs.

Linear Loading Rate Summary

Consideration of the LLR is important on all sites, particularly those where a hydraulically limiting layer is present (e.g. shallow groundwater or bedrock). This is especially important where a number of trenches or beds are arranged above each other on a slope or where a wide mound is proposed. By extending an EAA along a slope the LLR will be reduced.

The LLR of a proposed design can be tested by the following calculations:

For single bed or beds placed in series (end to end) designs:

LLR = Design hydraulic load/ maximum EAA length parallel to slope

For beds placed in parallel (stacked) designs:

LLR = (Design hydraulic load/ Total field area) x Total downslope bed width

Where: Total field area = (total downslope bed width + interbed spacing) x (bed length)

Total downslope bed width = the number of beds x individual bed width

Linear loading rates can be sourced from Table 6-5. Appendix 6 includes example calculations.

Draft

Table 6-5: Linear Loading Rates

Soil characteristics			Linear loading rates (litres/metre/day) ¹								
			Slope								
			<5%			5-10%			>10%		
Soil category	Soil texture	Structure	Depth of natural, unsaturated soil (cm)								
			20 - 30	31 - 60	>61	20-30	31-60	>61	20-30	31-60	>61
1	Gravels and medium-coarse sands	Structureless	50	62	75	62	75	87	75	87	99
	Fine sand and loamy sand	Structureless	43	56	68	50	62	75	62	75	87
2	Sandy loams	Weakly structured	43	56	68	50	62	75	62	75	87
		Massive	37	43	50	45	51	57	62	75	87
3	Loams	High/moderate structured	41	47	53	45	51	57	48	55	61
		Weakly structured or Massive	25	29	32	30	34	37	34	40	46
4	Clay loams	High/moderate structured	30	36	42	34	37	41	37	43	50
		Weakly structured	25	31	37	27	34	40	30	36	42
		Massive	N/A	N/A	N/A	N/A	N/A	N/A	N/A	N/A	N/A
5	Light clays	Strongly structured	25	31	37	27	34	40	30	36	42
		Moderately structured	25	31	37	27	34	40	30	36	42

Soil characteristics			Linear loading rates (litres/metre/day) ¹									
			Slope									
			<5%			5-10%			>10%			
Soil category	Soil texture	Structure	Depth of natural, unsaturated soil (cm)									
			20 - 30	31 - 60	>61	20-30	31-60	>61	20-30	31-60	>61	
		Weakly structured or Massive	N/A	N/A	N/A	N/A	N/A	N/A	N/A	N/A	N/A	N/A
6	Medium to heavy clays	Strongly structured	25	31	37	27	34	40	30	36	42	
		Moderately structured	25	31	37	27	34	40	30	36	42	
		Weakly structured or Massive	N/A	N/A	N/A	N/A	N/A	N/A	N/A	N/A	N/A	N/A

NOTES:

1. Adapted from Designing and Installing On-site Wastewater Management Systems from WaterNSW (2023a) and based on Hydraulic Wastewater Loading Rates to Soil Tyler (2001).

6.5 Drainage and Dosing Methods

This section outlines the different drain configurations to deliver effluent from a treatment system to dose an effluent application system.

Dosing Summary

Uncontrolled dosing refers to the dosing of effluent application systems by gravity trickle flow.

Controlled dosing refers to the methods for controlling the dosing of effluent application systems by either low-pressure or pressure techniques and can be on-demand or timer-controlled.

On-demand dosing refers to the dosing of effluent application systems in direct response to the production of wastewater, when the wastewater level has built up in the dosing tank. On-demand dosing methods include passive dosing systems or float-switch operated pumps.

Timer-controlled dosing refers to the discharge of equal volume doses to the effluent application system at pre-set regular timer intervals over 24 hours. Wastewater produced at peak production times during the day is buffered and discharged evenly throughout the day. A timer-controlled dosing method includes timer-operated pumps.

6.5.1 Gravity Dosing

Gravity dosing involves the uncontrolled trickle flow by gravity to deliver effluent to an effluent application system. This method relies on the slope of the land to achieve the necessary minimum grading required by AS3500.2:2018.

Gravity dosing is not as effective at achieving even distribution of effluent throughout an EAA compared to other methods. Trickle loading can result in progressive clogging of infiltration surfaces by biofilm development, commonly known as 'creeping failure'. Creeping failure is a common problem with gravity dosed systems where effluent emerges preferentially from the first few slots in large diameter slotted pipe. Creeping failure may be mitigated against or managed by alternate loading and resting cycles within the smaller components of the effluent application system (i.e. individual trenches or beds).

6.5.2 Passive Dosing Systems

Passive dosing systems use technologies such as floating outlets and siphons to deliver a low pressure dose of effluent without requiring a power supply. Passive dosing system change low or variable flows into regular doses and can be used in settings where there is sufficient height difference (typically 0.5-1.0 metre) between the tank inlet and the downslope effluent application system. The volume of the dose is determined by the basal area of the dosing chamber and the interval between the trigger and cut-off levels in the chamber.

Where these devices are incorporated into an OWMS design a separate pump/ dosing well is needed, or alternatively, within a dedicated dosing chamber within a septic tank. The dosing device and dosing well should be designed to hold a large enough dose to ensure that the entire length of the effluent application lateral can be fully charged for even distribution of the effluent throughout the dosing

cycle. In all cases other than mounds and sand filters, the dose should be set at a minimum of 200 litres or three times the fill volume of the downstream pipe system, whichever is the greater.

For low pressure systems using a siphon or floating outlet, a 500 litre or 1,000 litre dosing well is commonly used as, were the dosing device to fail, the system would automatically overflow to the EAA, reverting back to a gravity fed system, rather than surcharging to the ground surface.

Floating outlets

Floating outlets are a proprietary product that use an outlet with a calibrated buoyancy and a flexible connector. As effluent fills the dosing chamber, the empty device becomes buoyant and floats on the surface. When the effluent reaches the height which defines the set dose, it will overflow into the device causing it to sink to the bottom of the chamber, release the effluent and reset.

The floating outlet typically requires a minimum of approximately 0.5 metre interval between the chamber inlet and the EAA to be dosed.

Siphon

Passive dosing siphons use hydrostatic air pressure and gravity to create a surge of liquid. The device operates as effluent rises in a dosing chamber to trigger the siphon and dispense a dose. After the dose is dispensed, the siphon water seal breaks and the flow ceases. The siphon reliably resets and is automatically triggered again when the effluent level in the dosing chamber returns to the trigger level.

6.5.3 Pressure Dosing

Pressure dosing involves the use of a pump to supply pressure to ensure doses are distributed across the entire infiltrative surface of an EAA system rather than being concentrated at the inlet end.

Pumps should only be used within a dedicated chamber within a septic tank or treatment system or separate dosing tank (e.g. a pump well).

All pump chambers should include a high-water level alarm, which activates in the event of the water level rising above the design working volume in the pump chamber. There are a variety of float switches or probe systems available to activate alarms. The alarms should be both audible and visual. Audible alarms have the advantage that they are more frequently noticed and acted upon at an early stage, whereas visual alarms can be easily missed, resulting in a concentrated discharge from the chamber.

Pump Well Capacity Summary

$$\text{Minimum Pump Well Capacity (L)} = \text{Daily Hydraulic Load (L/day)} \times 1\text{-day} + 1\text{-day emergency storage capacity}$$

Any pump chamber associated with dosing an EAA should be sized to include 24 hours of emergency storage above the high water level alarm. Emergency storage allows sufficient time to be available in the event of a mechanical or electrical failure to rectify the problem. Alternatively, an individual pump chamber may overflow by gravity to another chamber that contains additional emergency storage capacity.

Pump Sizing

Designs should consider the system location and proximity to the EAA as this influences pump size and where to run irrigation mains. Pump sizes should be sufficient to meet the demands of the EAA.

Float switch operated

Float switches are devices used to detect the level of liquid within a tank. The switch is used to activate the pump at a specified water level as a form of on-demand dosing. Float switches alone do not provide a means of flow balancing.

Timer operated

Programmable timers installed in a control panel allows precise control of dosing by running pumps 'on' and 'off' cycles for pre-determined lengths of time. In a programmable timer controlled system, effluent is discharged from the tank in small, uniform doses over the course of the day instead of in the peak flow volumes that would be discharged all at once in a "demand" system. Residential timer cycles (on and off times) are usually set between 30 and 90 minutes. Timer cycles are calculated case by case and determined by the dose volume and the flow rate of the pump.

6.6 Distribution Methods

Distribution techniques, refer to the methods available to distribute effluent doses evenly among individual application system components (e.g. distributing effluent evenly across multiple absorption trenches or multiple irrigation zones).

6.6.1 Distribution Boxes

Use gravity and allows for even distribution of the wastewater load through level outlets that fill up with water once a certain water level is reached within the box. An adjustable outlet, such as an offset pipe reducer or 'Speed Leveller™' or similar, should be used in conjunction with a distribution box to equalise distribution box flow, alternate fields and/ or block or rest failed lines. These should be checked and adjusted regularly.

Where effluent is pumped to the distribution box, a velocity reduction device should be installed before the distribution box to prevent uneven discharged caused by effluent jetting into the distribution box. The distribution box top should be installed above the ground surface to prevent stormwater entry.

6.6.2 Hydraulically Operated Sequencing (Indexing) Valves

Require pressure to operate and automatically switch the flow to each different outlet port, in sequence, each time the pump activates. Allows for resting of zones, permits dosing of large areas with smaller pumps, reduces required pipe sizes and increases residual pressures.

6.6.3 Manually Operated Sequencing Valves

Works the same as hydraulically operated sequencing valves, however, must be manually changed over by a system operator or home owner. Due to the lower level of reliability where human intervention is required, manually operated sequencing valves are not recommended.

6.7 Viral Die-Off Modelling

Viral die-off modelling uses a methodology developed by Beavers and Gardner (1993) and further refined by Cromer et al. (2001) to model the transport of viruses present in effluent away from the

EAA and through saturated subsoil areas. The model considers the level of treatment, groundwater temperature and subsoil characteristics as factors controlling the movement of viruses.

The model is a conservative approach to modelling the fate and transport of all pathogens as bacteria have shorter die-off times than viruses and can therefore be assumed to be eliminated within a shorter distance. In addition, the model assumes saturated subsoil conditions where viruses will have lesser die-off times in unsaturated subsoil conditions.

A worked example is provided in Appendix 6 and includes required model parameters in detail.

6.8 Raised Onsite Effluent Application Systems

Effluent application systems may need to be raised above the ground surface level with the addition of good quality topsoil material (e.g. sandy loam to sandy clay loam) where:

- The required 0.6m separation between the base of an effluent application system and any identified limiting layer (i.e. shallow bedrock or groundwater) as prescribed by AS/NZS 1547:2012 cannot be achieved; or
- The effluent application system cannot be practically located above the necessary flood level for a development as prescribed by the local council.

Effluent application systems may be raised with the implementation of a stable batter slope or by the use of a retaining wall structure. Where batter slopes are proposed, the slope must be vegetated and a batter slope no steeper than 3(horizontal):1(vertical) is required around the entire perimeter of an EAA to allow for a stable incline for mowing.

Where a retaining wall design is proposed, the design must incorporate the necessary setback distance of 3m or 45° angle from the toe of the retaining wall to the EAA. A geotechnical engineer with experience in the design of retaining wall structures should be consulted to design and supervise construction of the wall and bed system where slope gradients are >20% or retaining walls are >1m.

6.9 Soil Amelioration

The results of the SSE may identify a natural soil profile to be acidic, sodic, dispersive or possess low fertility. One or several of these characteristics can reduce a soil's ability to sustainably manage applied effluent.

Soil amendments may be incorporated into an EAA during the installation stage to mitigate the potential effects of soil deterioration. The majority of common soil amendments (e.g. lime and gypsum) are only soluble in water to a limited degree, so where they are applied to the topsoil they must be incorporated and blended during construction. Where the soil amendments applied at the base of an EAA system they can be broadcasted across the prepared excavation hole. Surface applications will not improve soil conditions at depth.

Both lime (CaCO_3) and gypsum (CaSO_4) are common soil ameliorants containing calcium that can be added to a natural soil profile to improve a soil's CEC and Ca/Mg ratio as to improve fertility and soil structure. Lime can neutralise the effects of soil acidity unlike gypsum, however, is relatively insoluble at a soil pH above 4.5 where gypsum is more readily soluble (DPI 2021b). Therefore, depending on the soil chemistry, lime, gypsum or a combination of the two may be suitable to use as an ameliorant. Figure 6-4 indicates appropriate soil amendments. Generally, soil ameliorants are applied at a rate

between 0.2-0.5kg/m² of EAA (DPI 2021b). Where initial amelioration is required, this may need to be repeated on an annual basis as part of operation and management.

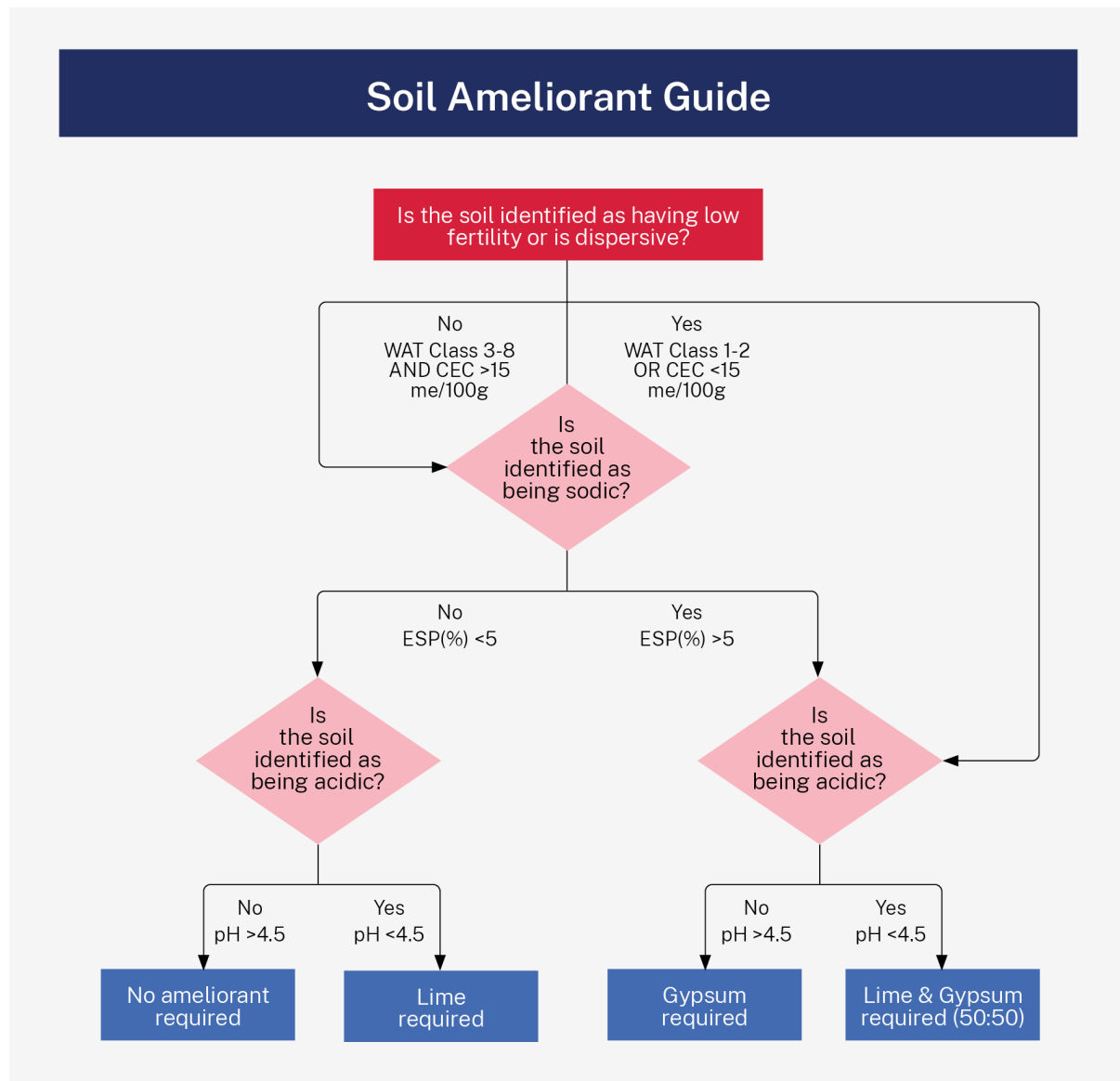

Figure 6-4: Soil Ameliorant Guide

6.9.1 Phosphorus Reducing Media

Various media possess a high P sorption capacity and these can be blended with natural soil in the EAA to increase the overall ability of the soil to sorb and take up P ('P-sorption'). Common P-sorbing media includes gypsum amended red mud, granulated blast furnace slag and weathered basalt soils (Krasnozems). Generally, the lifespan of these media is typically quite long, often in the range of 30-40 years or more, and once saturated with sorbed phosphorus, the media needs to be disposed of and replaced (Bishop et al 2007; Kayaalp et al. 1998).

The ability to incorporate P-sorbing media into an EAA can be dependent on its availability and cost. Availability of P-sorbing material may be dependent on a locally available source. P-sorbing media should only be used where scientific evidence supports its use.

Use of P-sorbing media in an additional treatment stage is an alternative option to incorporation of media into the EAA soils.

6.9.2 Stormwater Diversion

Stormwater diversion devices are recommended as the performance of the EAA can be adversely affected if stormwater is allowed to run onto and saturate these areas. Stormwater diversion devices are designed and constructed to collect, divert and dissipate collected run-on away from the EAA. The outlet should be stabilised and divert water in a safe location where it will not create an erosion hazard or impact on structures or neighbouring properties.

Stormwater diversion devices commonly comprise 100mm agricultural pipe placed within a distribution aggregate below a drain with a gradient 1-5% in the direction of flow.

Figure 6-5 demonstrates a typical stormwater diversion device.

The location of the EAA and stormwater infrastructure for buildings on the site should be coordinated so that neither negatively impact the other's performance. This may mean physical separation of stormwater dissipation trenches from an EAA.

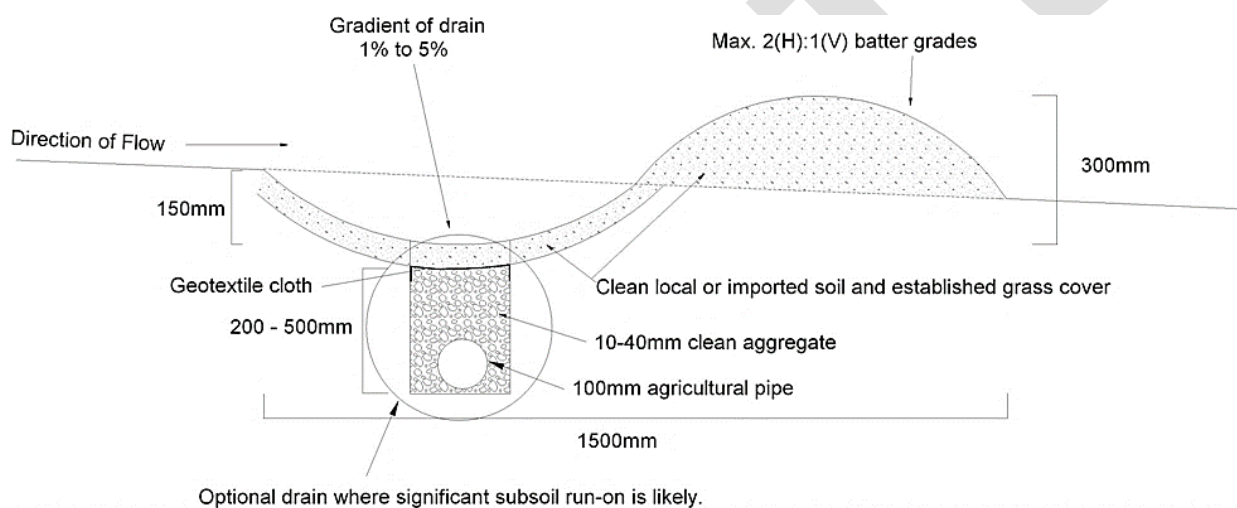

Figure 6-5: Typical Schematic of a Stormwater Diversion Device

Adapted from Designing and Installing On-site Wastewater Management Systems from WaterNSW (2023a).

6.9.3 Suitable Vegetation

All EAAs should be suitably vegetated immediately following construction. Managed lawn surfaces provide a high evapotranspiration rate and are recommended best practice for the majority of EAAs.

Large trees and shrubs and species with invasive roots should not be planted on EAAs. Roots can interfere with the functioning of treatment systems, plumbing pipework, subsurface irrigation systems and soil absorption systems. The shading of EAAs can reduce evaporation (although this might sometimes be offset by an increase in transpiration). Plant large trees at a distance from the EAA that is equivalent to the expected tree height. Shrubs, ground covers, sedges and grasses that grow to 0.5 - 1 metre are appropriate to plant in EAAs.

EAAs should be located 1 metre from the drip line of existing trees and shrubs to limit the impact on the vegetation and the risk to the EAA.

6.9.4 Reserve Areas

Reserve areas refer to an area set aside from future development to serve as a back-up in the event of an EAA failure. The requirement of a reserve area is typically set by the local council. It is recommended that reserve areas are required for EAA systems dosed with primary treated effluent due to the greater risk of general failure of the EAA due to clogging of the soil.

Reserve areas are not essential for mounds and EAA systems dosed with secondary treated effluent, as the higher level of treatment reduces the risk of generalised failure of the EAA, and mounds allow the replacement of the EAA within the same footprint. SSI EAAs are a low risk of generalised failure due to the low application rate, high effluent quality and use of pressure compensating drippers for even application of effluent.

At subdivision stage, it is recommended that a 100% reserve area is nominated to ensure sufficient area is available within each lot for long term application of effluent.

Section 7: Onsite Wastewater Management System Selection

**When assessing the selection of an
OWMS, many important issues need to
be considered**



Section 7. Onsite Wastewater Management System Selection

7.1 Introduction

It is important to commence any assessment of a selected system from the site and soil constraints and work 'backwards' through the treatment train asking the following key questions:

- Is it an appropriate effluent application system based on the constraints imposed by site and soil features and the predicted wastewater load?
- What is the required effluent quality (i.e. does it need disinfection?) for the site sensitivity and EAA design?
- Will the treatment and ancillary systems achieve the effluent quality and the objectives for the site?
- Will the current and future owner/ occupants be able to operate and maintain the system successfully?

When assessing the selection of an OWMS, many important issues need to be considered, including:

- Does the system design address the most limiting site and soil characteristics;
- Site suitability, including environmental sensitivity;
- The sustainability of the proposed system;
- Availability and location of a reliable power source;
- The practicality of the design given the intended occupancy and use of the site;
- The expectations of the current and future residents of the development and their likely commitment to proper operation and maintenance of the system;
- System lifespan, including replacement or refurbishment at some later date;
- System reliability and the quality of service offered by the manufacturer (if any);
- The availability of service agents in the area and their quality of service;
- Installation and operational costs;
- The impact of the system on the amenity of the area;
- The development of contingency plans in the event of system failure, including a reserve EAA for primary treatment systems;
- Whether onsite management is a long-term management strategy, or only an interim measure before connection to a centralised sewerage system; and
- The cumulative public health and environmental impacts of present and future OWMSs within the subdivision or catchment (at subdivision stage).

Various combinations of OWMS processes are possible, and not all OWM processes are suitable or desirable at all sites. An appropriate system is one that is suitably matched to site and soil characteristics (and in particular the most limiting factors) as well as being functional and economically feasible for the particular use.

7.2 Constraints and System Selection

The factors that limit a site's capability to achieve Total OWM are listed in Table 7-1 with recommended mitigation practices. The advantages and limitations of treatment system and effluent application systems are listed in Table 7-2 to aid system selection for constrained sites.

Table 7-1: Constraints to Total OWM

OWM Constraint	Description	Mitigation
Small lot size or limited available EMA	<ul style="list-style-type: none"> Limited area for complete hydraulic and nutrient uptake within an EAA Limited available buffers EAA will likely have multiple uses due to limited space 	<ul style="list-style-type: none"> Minimise wastewater generation (water saving fixtures) Source separation approaches (WCT systems and greywater recycling) Improve effluent quality and reduce nutrients (e.g. advanced secondary STS with nutrient reduction) Minimal footprint for treatment system and EAA Nominate optimal exposure EAA if possible
Slope - flat or convergent	<ul style="list-style-type: none"> Poor drainage Run-on from surface and subsurface 	<ul style="list-style-type: none"> Divert all run-on, surface and subsurface Modify the ground surface Raised EAA options

OWM Constraint	Description	Mitigation
Slope - moderate to steep	<ul style="list-style-type: none"> ● Construction challenges ● Erosion risk ● Design and installation are critical ● Future maintenance access 	<ul style="list-style-type: none"> ● Upslope diversion drains ● Erosion and sediment controls ● DIR/ DLR reductions ● Pressure dosing for even distribution ● Meet LLR requirements ● Shallow and narrow trenches or irrigation lines to be installed along the contour ● Benching where practical ● Retaining wall designs may be suitable ● May require geotechnical risk assessment/ advice
Slope instability or mass movement areas	<ul style="list-style-type: none"> ● Onsite effluent application may increase risk of instability ● System components may break or fail during movement events 	<ul style="list-style-type: none"> ● Minimise wastewater generation ● DIR/ DLR reductions ● May require geotechnical risk assessment/ advice
Flooding/ periodic inundation	<ul style="list-style-type: none"> ● Water ingress into treatment system or can overload the system, add flood debris and cause system failure ● Soil saturation following flood events 	<ul style="list-style-type: none"> ● Locate the treatment system and electrical components above the 1%AEP flood level ● Locate the EAA above the 5%AEP flood level ● Install a pressure seal on lid of treatment systems to prevent water ingress if within flood zone ● Install electrical components in a raised position if unable to install treatment system above 1%AEP flood level ● Tank anchoring is critical ● Pressure dosed EAA ● Flood recovery plan for entire OWMS

OWM Constraint	Description	Mitigation
Climate (area with heavy rainfall and evaporation)	<ul style="list-style-type: none"> ● Reduced performance of systems that rely only on evaporation processes ● Can cause additional run-on to enter the system 	<ul style="list-style-type: none"> ● Conservative design, including water balance ● DIR/ DLR reductions if no water balance ● Upslope diversion drains ● EAA with good exposure ● Pressure dosed subsurface irrigation preferred. Surface irrigation not recommended ● Absorption systems or ETA systems with in-bed wet weather storage recommended ● Downslope interceptor bunds/ drains to divert run-off to holding dam ● Maintenance and oversight are critical
Climate (bushfire prone areas)	<ul style="list-style-type: none"> ● Higher chance of system failure from bushfire damage ● Shallow PVC pipes may be damaged 	<ul style="list-style-type: none"> ● Concrete treatment systems preferred over plastic and fibreglass systems as concrete is more resilient to fire damage ● Subsurface effluent application systems in maintained lawn areas ● Signage or fencing to protect treatment system and EAA from fire truck damage
Shallow limiting layers (bedrock or water table)	<ul style="list-style-type: none"> ● Limited buffers ● Subsoil treatment processes can be short circuited before effluent enters the receiving environment ● Groundwater pollution risk ● Seepage risk 	<ul style="list-style-type: none"> ● Meet LLR requirements ● Secondary treated effluent to reduce required buffers ● Raised beds or mounds to increase buffer distance ● Imported soil may be required, with its own limitations ● Tank anchoring is critical (water table)

OWM Constraint	Description	Mitigation
Low permeability soils (medium to heavy clays)	<ul style="list-style-type: none"> • More prone to waterlogging and surface seepage 	<ul style="list-style-type: none"> • Specialist design including permeability testing (category 5b, 5c and 6 soils) • Minimise wastewater generation • DIR/ DLR reductions • Pressure dosing for even distribution • Alternate dosing between EAA areas (sequencing valve) (e.g. SSI zones or absorption beds) • Shallow application into higher permeability upper layers • Use of raised application methods, such as a sand mound to improve evapotranspiration
High permeability soils (sands and gravels)	<ul style="list-style-type: none"> • Low nutrient retention capacity • Higher risk to groundwater 	<ul style="list-style-type: none"> • Improve effluent quality including disinfection and nutrient reduction processes • Shallow subsurface application with closely spaced irrigation lines and/ or emitters to maximise evapotranspiration, rather than deep soakage • Even effluent distribution critical across whole EAA as movement will be vertical • Pressure dosing for even distribution • Alternate dosing between EAA areas (sequencing valve) (e.g. SSI zones or absorption beds)

OWM Constraint	Description	Mitigation
Environmentally sensitive areas ¹	<ul style="list-style-type: none"> Protect from the risk of off-site export of contaminants of concern (COCs) contained in effluent. 	<ul style="list-style-type: none"> Conservative design, including water and nutrient balance Improve effluent quality including disinfection (double disinfection) and nutrient reduction processes Subsurface or subsoil application Pressure dosing for even distribution
Fill or disturbed soil	<ul style="list-style-type: none"> Uneven permeability Uneven settlement Poor structure 	<ul style="list-style-type: none"> Additional investigation for design Careful fill placement and compaction techniques DIR/ DLR reductions Pressure dosing for even distribution Flexible couplings for treatment system and pipework
Off-grid/ solar only sites	<ul style="list-style-type: none"> Require no or low energy OWMS 	<ul style="list-style-type: none"> Energy use for electrical components should be considered in a solar budget, including for AWTS Primary treatment with absorption system recommended Passive dosing systems provide a no-energy best practice dosing option Passive polishing systems can provide low energy options Specialist guidance required if using DC pumps
<p>NOTES</p> <p>1. Environmentally sensitive areas include drinking water catchments, oyster aquaculture areas, RAMSAR wetlands, and sensitive groundwater.</p>		

Table 7-2: Advantages and Limitations of Conventional OWS Components

OWMS Component	Advantages	Limitations
Treatment systems		
Septic tank	<ul style="list-style-type: none"> ● Low energy requirement ● Ability to handle shock or intermittent flows ● Relatively cost effective to increase capacity ● First step of passive polishing systems ● Basic maintenance 	<ul style="list-style-type: none"> ● Primary treated effluent is highly infectious and polluting ● Limited EAA options without additional treatment ● Lower DLR for EAA, means larger footprint ● Higher buffers for EAA ● EAA requires greater soil depth
Wet Composting System (WCS)	<ul style="list-style-type: none"> ● Low energy requirement ● Viewed as “green” option ● Ability to add kitchen scraps 	<ul style="list-style-type: none"> ● Current WCS accreditations are only for primary treatment ● As for septic tanks ● Primary treated effluent is highly infectious and polluting ● Limited ability to handle shock or intermittent flows as worms require a constant food-source
Waterless Composting Toilet (WCT) system	<ul style="list-style-type: none"> ● Ability to handle shock or intermittent flows ● Minimises wastewater generation ● Little effluent to manage 	<ul style="list-style-type: none"> ● High operator hands-on maintenance requirements including compost application ● Limited compost processes in cold climates ● Requires separate greywater management ● Specialist management required for sites with large liquid loads
Aerated Wastewater Treatment System (AWTS)	<ul style="list-style-type: none"> ● Higher quality effluent produced ● Wide variety of AWTS are commercially available ● Low operator maintenance inputs, “set and forget” which is good for rental properties ● Greater EAA options ● Reduced buffers for EAA ● Can be cheaper installation cost than passive application options ● Small treatment system footprint for 8-10 persons 	<ul style="list-style-type: none"> ● Limited ability to handle shock or intermittent flows unless system designed for such (holiday mode) ● High maintenance requirements including costs of service contract ● High sensitivity of performance to poor maintenance ● High energy requirement ● Not all remote areas have service agents readily available

OWMS Component	Advantages	Limitations
Treatment systems		
Aerobic Sand and Media Filter (ASMFS) system	<ul style="list-style-type: none"> ● Higher quality effluent produced ● Ability to handle shock or intermittent flows ● Low energy requirement ● Greater EAA options ● Reduced buffers for EAA ● Minimal running cost ● Custom sized to flows 	<ul style="list-style-type: none"> ● Sand may not be available locally ● Maintenance often left to owner/ operator discretion, with variable results ● Costly damage to sand filter if primary treatment tank not maintained ● Higher installation cost ● Treatment system footprint can be larger as must include primary treatment prior to ASMFS
Constructed wetland	<ul style="list-style-type: none"> ● Higher quality effluent produced ● Low energy requirement ● Viewed as “green” option ● Basic owner/ occupant completed maintenance ● Greater EAA options ● Reduced buffers for EAA ● Minimal running cost ● Custom sized to flows ● Nitrogen reduction 	<ul style="list-style-type: none"> ● Maintenance often left to owner/ operator discretion, with variable results ● Costly damage to wetland filtration if primary treatment tank not maintained ● High installation cost ● Treatment system footprint larger as must include primary treatment prior to wetland and requires separate EAA
Passive polishing systems		
Mounds	<ul style="list-style-type: none"> ● Can overcome shallow soil limitations (low permeability soils, shallow groundwater) ● Passively improves effluent quality ● Low health risk. Subsurface application provides separation to occupants ● Primary or secondary treated effluent suitable 	<ul style="list-style-type: none"> ● Energy requirement as pressure dosing required ● Higher installation costs Not suitable in moderate slope (>15%) areas due to risk of toe seepage ● Mound can neutralise available space in smaller lots
Bottomless sand filter	<ul style="list-style-type: none"> ● Can overcome shallow soil limitations (low permeability soils, shallow groundwater) ● Passively improves effluent quality ● Low health risk. Subsurface application provides separation to occupants 	<ul style="list-style-type: none"> ● Energy requirement as pressure dosing required ● Higher installation costs Not suitable in moderate slope (>15%) areas due to risk of toe seepage ● Mound can neutralise available space in smaller lots

OWMS Component	Advantages	Limitations
Treatment systems		
	<ul style="list-style-type: none"> ● Primary or secondary treated effluent suitable 	
Pipe, textile and sand systems (AES and Eljen)	<ul style="list-style-type: none"> ● Passively improves effluent quality ● Low health risk. Subsurface application provides separation to occupants ● Primary or secondary treated effluent suitable ● Can be installed in raised formation for shallow soils 	<ul style="list-style-type: none"> ● Limited installers
Recirculating evapotranspiration channel systems	<ul style="list-style-type: none"> ● Reduces effluent volume or no release option ● Improved effluent quality ● No limitation from shallow or no soils 	<ul style="list-style-type: none"> ● High cost of installation and initial pump out cycle prior to vegetation canopy establishment ● Concentration of salts within no release option needs addressing in maintenance ● High maintenance cost and specific maintenance regime ● Relatively large footprint of pods with large vegetation canopy for most effective performance
Amended soil mounds	<ul style="list-style-type: none"> ● Phosphorus reduction ● Additional polishing treatment if correct sand media used 	<ul style="list-style-type: none"> ● No additional treatment ● Poor effluent distribution in surrounding EAA ● Limited effectiveness for clay soils
EAA systems		
Absorption systems	<ul style="list-style-type: none"> ● Robust ● Low energy requirement ● Smaller footprint than irrigation ● Accounts for wet weather storage and variations in flow ● Long life, especially if pressure dosed 	<ul style="list-style-type: none"> ● Large EAA in low permeability soils (medium to heavy clays) ● Specific design required and potential for construction challenges in moderate slope (>15%) areas without specific design ● Requires deeper soils

OWMS Component	Advantages	Limitations
Treatment systems		
	<ul style="list-style-type: none"> ● Low health risk. Subsoil application provides separation to occupants ● Primary or secondary treated effluent suitable 	<ul style="list-style-type: none"> ● Higher installation costs than irrigation ● Higher installation impact (construction and established trees)
EvapoTranspiration Absorption (ETA) trench/ bed systems	<ul style="list-style-type: none"> ● Low energy requirement ● Smaller footprint than irrigation ● Accounts for wet weather storage ● Long life, especially if pressure dosed ● Suitable for lower permeability soils ● Low health risk. Subsoil application provides separation to occupants ● Primary or secondary treated effluent suitable 	<ul style="list-style-type: none"> ● Beds not suitable in moderate slope (>10%) areas without specific design ● Requires deeper soils ● Higher installation costs than irrigation ● Higher installation impact (construction and established trees)
Wick system	<ul style="list-style-type: none"> ● Improved evapotranspiration over absorption alone ● Reduced cost to equivalent ETA trenches or beds ● As for absorption and ETA systems 	<ul style="list-style-type: none"> ● Risk of geotextile fabric clogging if installed at base of trench ● As for absorption and ETA systems
Subsurface Irrigation (SSI)	<ul style="list-style-type: none"> ● Beneficial re-use of effluent suitable for lawn and garden areas ● Can be installed around mature tree driplines ● Relatively low cost ● Low health risk. Subsurface application provides separation to occupants ● Minimal construction impact ● Pressure compensating drippers reduce the risk of slight variations in slope and zone shape ● Minimal soil depth required 	<ul style="list-style-type: none"> ● Requires secondary treatment and disinfection at minimum ● High quality effluent essential or blockages occur ● Larger footprint ● Not suitable in steep slope areas (>30%) without specific design ● Moderate risk of damage due to shallow depth ● Can have a shorter lifespan than trenches/ beds ● Risk of freezing in cold climates

OWMS Component	Advantages	Limitations
Treatment systems		
Surface Irrigation (SI)	<ul style="list-style-type: none"> ● Minimal construction impact ● Low cost ● Beneficial re-use ● Minimal soil depth required ● Direct evaporation if not raining ● Improved large droplet sprinklers available 	<ul style="list-style-type: none"> ● High health risk. Potential human contact with effluent, especially in small lots or highly trafficable areas ● Requires secondary treatment and disinfection at minimum ● Larger footprint ● Larger buffers for EAA ● Not suitable in heavy rainfall climate areas ● Not suitable in moderate slope areas (>10%) due to risk of run-off, especially in wet weather ● Risk of spray drift ● High risk of damage ● High risk of misuse (movable sprinklers) ● Risk of freezing in cold climates

Glossary

Glossary, Bibliography: References and Further Reading



Glossary

Accreditation: refers to the process of accreditation by the Secretary of the NSW Ministry of Health of certain single domestic SMF under sections 40 and 41 of the *Local Government (General) Regulation 2021*. A council cannot approve the installation of these SMF without accreditation.

Absorption (soil): uptake of liquid into soil.

Adsorption (soil): increased concentration of molecules or ions on a soil or media particle surface, including exchangeable cations and anions.

Aerated wastewater treatment system (AWTS): a wastewater treatment system involving aerobic treatment to promote oxidation and microbiological consumption of organic matter by bacteria through facilitating biological processes to achieve a secondary or advanced secondary effluent quality performance.

Aerobic: refers to a biochemical state where molecular (dissolved or free) oxygen is present.

Aggregate: rock or stone media of particular specifications.

Anaerobic: refers to a biochemical state where molecular (dissolved or free) oxygen is not present.

Anaerobic digestion: decomposition of sludge in the absence of oxygen facilitated by microorganisms.

Anion: negatively charged ion; can be a single element such as chloride (Cl⁻) or a compound such as nitrate (NO₃⁻).

Aerobic sand and media filter (ASMFS): (intermittent or recirculating filter) provides further treatment of pre-treated wastewater by percolation through graded filter media.

Authorised person (from the LG Act):

(a) an employee of a council generally or specially authorised by the council in respect of or whose duty it is to deal with, or to act in regard to, any acts, matters or things in relation to which the expression is used, or

(b) a police officer.

Basal loading rate (BLR): the effluent loading rate for a particular soil type and applied to Wisconsin sand mound calculations (expressed in L/m²/day or mm/day). Takes into account the evaporation effect of the mounded surface.

Biochemical oxygen demand (BOD): a measure of the dissolved oxygen required for the breakdown of organic material in wastewater or effluent; usually refers to a 5-day test (BOD₅), which typically represents 70-80% of the total BOD in a sample; expressed in milligrams per litre (mg/L).

Biological film: (zoogloal film) gelatinous-like film that forms on the surfaces of inert materials, forming the media in a biological filter; it can contain bacteria, protozoa and fungi, and is the site where organic matter in the wastewater is oxidised or degraded. Also known as biofilm.

Biosolids: primarily organic solid product produced by wastewater treatment processes. The solids become biosolids when they come out of a digester or other treatment process and can be beneficially used. Until such solids are suitable for beneficial reuse they are defined as wastewater solids.

Blackwater: human excreta and water grossly contaminated with human excreta, for example toilet wastewater (although not strictly water-based, human excreta entering waterless composting toilets is considered as 'blackwater').

Buffer distance: the separation distance between an effluent application area and a sensitive receptor or other particular feature such as a property boundary.

Catchment: a hydrological catchment or area of land where surface water drains through a network of drainage lines and streams to a single outlet.

Cation: positively charged ion; can be a single element such as potassium (K^+) or a compound such as ammonium (NH_4^+).

Cation exchange capacity (CEC): a measure of the ability of a soil to attract and hold cations by electrical attraction; three important plant nutrients are the cations calcium (Ca^{2+}), magnesium (Mg^{2+}) and potassium (K^+).

Centralised sewerage system: the collection of all sewer and sewerage works vested in the local authority. Usually consists of a wastewater transport system (sanitary drainage system and/ or road tanker) and centralised wastewater management facility for many premises.

Centralised wastewater management facility: a facility vested in the local authority and designed for the management of wastewater and/ or septage generated by many households. Examples of possible facilities are:

- Package treatment plants
- Full-scale sewage treatment plants
- Biosolids management facilities
- Effluent re-use facilities
- Effluent discharge facilities.

Compost: the material produced by the aerobic biological decomposition of the organic constituents of a material.

Constructed wetland: an artificial wetland used to treat wastewater, stormwater or industrial wastewater using the natural processes of wetland vegetation, micro-organisms and the aggregate.

Crop factor: a coefficient used to calculate evapotranspiration (the proportion of evaporation transpired by plants). The crop factor represents the ratio of crop evapotranspiration to pan evaporation and varies by species of plant and season.

Denitrification: transformation of nitrate into the gaseous NO and N forms; denitrification is an anaerobic process carried out by micro-organisms; it can occur only if the soil (or environment) becomes oxygen deficient (for example, as a result of waterlogging or in an anaerobic chamber of a treatment system).

Design irrigation rate (DIR): the soil dependent effluent loading rate for irrigation area calculations expressed in $L/m^2/day$ or mm/day .

Design loading rate (DLR): the soil dependent effluent loading rate for soil absorption area calculations expressed in $L/m^2/day$ or mm/day .

Desludging: removal of accumulated sludge and scum from a tank or chamber.

Die-off: refers to the death of a microorganism due to natural causes.

Disinfection: a process that destroys, inactivates or removes pathogenic micro-organisms.

Dispersive soil: soils that are structurally unstable and disperse in water into basic particles (sand, silt and clay). Dispersive soils tend to be highly erodible.

Domestic wastewater: wastewater originating from household or personal activities, including toilets, bathrooms, kitchens and laundries.

Domestic treatment systems: as those with a capacity of up to 5,000L/day that treat domestic wastewater.

Drainage depression: naturally defined low points that carry water during rainfall events but dry out quickly when rainfall stops. A drainage depression is considered to be an intermittent watercourse.

Drinking water catchment (adapted from EP&A Regulation 2021): land in a restricted area prescribed by a controlling water authority, including WaterNSW and councils. Also includes the surface water inner catchment or 'reservoir protection zone'. 'Typically surface water inner catchment reservoir protection zones, including feeder streams, within Australia are 2 to 3 km from reservoir highwater level' from page 84 of the Australian Drinking Water Guidelines 6 Version 3.8 (National Health and Medical Research Council 2011, updated 2022).

Dwelling: a room or suite of rooms used or capable of being used as a separate place of residence.

Effluent: the liquid discharged from a wastewater treatment unit (treated wastewater).

Effluent application area (EAA): the area over which effluent is applied to land.

Effluent application system: system that can consist of pumps, pipes, nozzles, or trenches designed to apply effluent evenly over an effluent application area. Includes both irrigation systems and soil absorption systems.

Electrical conductivity (EC): an electrical measure of the concentration of salts in solution; the salts that occur in significant amounts in domestic wastewater are the chlorides, sulphates and bicarbonates of sodium, potassium, calcium and magnesium; in water these salts dissociate into charged ions and the EC of the solution is proportional to the concentration of these ions. The units of EC are deciSiemens per metre (ds/m) at 25°C.

Emerson Aggregate Test (EAT) (or Modified Emerson Aggregate Test): a field test for assessment of aggregate stability or dispersibility.

Environmentally sensitive area: includes (from LG Regulation):

(a) land or an area listed in the definition of environmentally sensitive area of State significance in Part 1 of Schedule 3 to the [Environmental Planning and Assessment Regulation 2021](#), and

(b) any land or area:

- (i) within 100 metres of a natural waterbody, wetland or coastal dune field, or
- (ii) with a high watertable, or
- (iii) with highly permeable soils or acid sulphate, sodic or saline soils, or
- (iv) within a drinking water catchment, or
- (v) within the water catchment area of an estuary where the entrance to the sea is intermittently open.

Equivalent population (EP): a measure typically used in the design of wastewater management systems. Because there are differences in wastewater generation rates between premises with and without reticulated water supplies, and premises with dry composting

toilet technologies, it is usually easier to stipulate design limits by an 'equivalent' number of people rather than the total flow.

Evapotranspiration: removing water from soil by evaporation and from plants by transpiration. Evapotranspiration can be calculated by multiplying evaporation by an appropriate crop factor.

Faecal coliforms (fc): a type of bacteria that live only in the gut of warm-blooded animals. Can be detected in the general environment if that environment is contaminated with human or animal excreta, and therefore can act as an indicator of recent faecal contamination.

Free-draining soil: soil, beneath the point of application and above any limiting layer, through which effluent can pass freely under gravity. There must be a minimum of 0.6 metre of free-draining soil beneath the point of application in any effluent application system.

Greywater: (sullage) domestic wastewater from sources other than toilets, including hand-basins, showers, washing machines, dishwashers and kitchens.

Ground surface: the upper surface of the natural or imported soil in an effluent application system.

Groundwater: water collected in saturated layers of soil, sediment or porous rock below the land surface as aquifers. Aquifers in geological formations are permeable enough for water to move within them and be discharged or extracted.

Human waste or excreta: human faeces and urine.

Human waste storage facility (HWSF): device for holding or disposing of human waste, including a cesspit, septic closet, water closet, chemical closet, humus closet and combustion closet. (from the LG Act).

Human waste treatment device (HWT): device for treating human excreta and other wastewater, including a septic tank, aerated wastewater treatment system, septic closet, water closet, humus closet and combustion closet (from the LG Act).

Hydraulic loading rate (hydraulic load, hydraulic loading): the amount of liquid applied to land over a specified time interval. Can be expressed as either a depth or a volume (with one millimetre of application equal to one litre per square metre).

Hydraulic retention time (HRT): the average amount of time that wastewater spends within a chamber or tank.

Landform element: an area with a definable slope, toposequence, position, and land surface features. Landform elements typically have characteristic dimensions of greater than 40 metres and less than 600 metres diameter. Examples are hillcrests, footslopes, swales and levees. Seventy types of landform element are described in Speight (1990).

Limiting layer: the layer of soil with the lowest hydraulic conductivity (permeability) or any other low hydraulic conductivity layer such as a hard pan or bedrock, or the water table, or seasonal high water table (as evidenced by soil mottling), within 0.6 metre beneath the point of application. The design loading rate is based on the hydraulic conductivity of the limiting layer.

Linear loading rate: the rate of effluent applied to the soil around an effluent infiltration system that is perpendicular to the landscape contour and flows downgradient in the subsurface (expressed in L/m/day).

Nitrification: transformation of inorganic ammonium (NH_4^+) into nitrate (NO_3^-).

Nutrients: chemical elements that are essential for sustained plant or animal growth. The major nutrients essential for plant growth are nitrogen, phosphorus and potassium. In excess,

nitrogen and phosphorus are potentially serious pollutants encouraging nuisance growths of cyanobacteria and aquatic plants in waters and (in the case of nitrate) posing a direct human health risk.

Nutrient uptake area (NUA): the area downslope of the EAA in which nutrients (nitrogen and phosphorus) are further assimilated in the receiving environment and which is set aside from future development.

Occupant: (from the LG Act) includes: (a) a person having the charge, management or control of premises”.

Onsite sewage management: see onsite wastewater management.

Onsite wastewater management: the management of wastewater treatment and effluent application within the boundaries of the site it was generated within.

Onsite wastewater management system: a wastewater system that treats and land applies wastewater within the boundaries of the site the wastewater was generated within.

“operate a system of sewage management” (from Section 68A of LG Act):

(1) In this Part, **operate a system of sewage management** means hold or process, or re-use or discharge, sewage or by-products of sewage (whether or not the sewage is generated on the premises on which the system of sewage management is operated).

(2) Without limiting subsection (1), **operate a system of sewage management** includes the following:

- (a) use artificial wetlands, transpiration mounds, trenches, vegetation and other effluent polishing, dispersal or re-use arrangements in related land application areas,
- (b) hold or process sewage that is to be subsequently discharged into a public sewer.

(3) However, **operate a system of sewage management** does not include any of the following:

- (a) any action relating to the discharge of sewage directly into a public sewer,
- (b) any action relating to sewage or by-products of sewage after their discharge into a public sewer.

Organic matter: material consisting of chemical compounds based upon carbon skeletons (proteins, carbohydrates and fats); may be present in dissolved, suspended and colloidal form; it is usually measured as BOD in a liquid.

Organic matter loading: the amount of organic matter applied to land over a specified time interval. The amount of organic material in effluent is usually expressed as BOD.

Outlet filter: a device fitted to the outlet of a septic tank which retains total suspended solids (TSS) typically greater than 3mm size in the tank to prevent carry-over to the EAA.

Owner (from LG Act):

(b) in relation to land other than Crown land, includes:

- (i) every person who jointly or severally, whether at law or in equity, is entitled to the land for any estate of freehold in possession, and
- (ii) every such person who is entitled to receive, or is in receipt of, or if the land were let to a tenant would be entitled to receive, the rents and profits of the land, whether as beneficial owner, trustee, mortgagee in possession, or otherwise, and
- (iii) in the case of land that is the subject of a strata scheme under the [Strata Schemes Development Act 2015](#), the owners corporation for that scheme constituted under the [Strata Schemes Management Act 2015](#), and

(iv) in the case of land that is a community, precinct or neighbourhood parcel within the meaning of the [Community Land Development Act 2021](#), the association for the parcel, and

(v) every person who by this Act is taken to be the owner.

Partial onsite wastewater management: the preliminary treatment of wastewater onsite, followed by management in a centralised sewerage system.

Pathogens: micro-organisms that are potentially disease-causing; these include but are not limited to bacteria, protozoa and viruses.

Percolation: the descent of water through the soil profile under gravitational forces.

Performance based design: an approach to achieving performance that allows designers to develop solutions to achieve a numerical performance requirement (e.g. Effluent quality performance criteria specified by relevant Australian Standards) that can provide for flexibility and innovation in design, based on the results of the site and soil evaluation.

Permeability: the general term used to describe the rate of water movement through a soil.

Permeameter: a device to measure the permeability (hydraulic conductivity) of the soil under a constant head of water.

Ph: a measure of hydrogen ion concentration. It is an indicator of acidity or alkalinity and ranges from 0-14, where 0 is the most acid, 14 the most alkaline, and 7 neutral.

Point of application: the point at which effluent is applied to the soil. This is the level of the emitters in an irrigation system or the base of a trench or bed system.

Potable: water of a quality suitable for drinking and domestic use that does not deteriorate on storage and that does not contain pathogenic organisms.

Precipitation: deposits of water, either in liquid or solid form, that reach the earth from the atmosphere.

Recurrence interval: (in these Guidelines) a statistical average time between events.

Reed bed: a type of constructed wetland.

Regolith: loose, incoherent fragments of soil, alluvium, etc. Which make up surficial deposits and rest upon solid rock.

Related land application area, in relation to a sewage management facility, (from the LG Act): the area of land (if any) where it is intended that effluent and bio-solid waste from the facility will be re-used, applied or dispersed into the environment.

Residual chlorine: chlorine remaining in solution after a specified period of contact between the solution and the chlorine.

Reticulated water supply: the provision by a water authority of water for potable and non-potable uses to households through a network of pipes.

Run-off: the part of the precipitation and/ or land applied effluent that becomes surface flow because it is not immediately absorbed into or detained on the soil.

Run-on: surface water flowing on to an effluent application area as a result of run-off occurring higher up a slope.

Sand filter: A secondary treatment technology using a bed of select sand through which primary treated effluent is passed for treatment.

Sand mound: (see Wisconsin mound).

Scum: material that collects at the top of primary wastewater treatment tanks, including oils, grease, soaps and plastics. Also known as crust.

Separation distance: the separation between the point of application and a limiting layer. The separation distance between the point of application and the limiting layer should be a minimum of 0.6 metre.

Septage: material pumped out from septic tanks or primary chambers, during desludging; contains partly decomposed scum, sludge and liquid.

Septic tank: wastewater treatment device that provides a preliminary form of treatment for wastewater, comprising sedimentation of settleable solids, flotation of oils and fats, and anaerobic digestion of sludge.

Septic wastewater: wastewater that contains no dissolved oxygen; it is black, has a foul odour, and contains high numbers of pathogenic organisms.

Sewage: *see wastewater.* (LG Regulation - sewage includes any effluent of the kind referred to in paragraph (a) of the definition of waste in the Dictionary to the LG Act).

Sewage management: any activity carried out for the purpose of holding or processing, or reusing or otherwise disposing of, sewage or by-products of sewage.

Sewage management facility (from the LG Act and LG Regulation):

- (a) a human waste storage facility, or
- (b) a waste treatment device intended to process sewage, and includes a drain connected to such a facility or device.

Sewage of a domestic nature (from LG Act): includes human faecal matter and urine and waste water associated with ordinary kitchen, laundry and ablution activities of a household, but does not include waste in or from a sewage management facility.

Sewerage work: the construction, alteration, extension, disconnection, removal, ventilation, flushing, cleansing, maintenance, repair, renewal or clearing of any sewerage service pipes or fittings or fixtures communicating or intended to communicate, directly or indirectly, with:

- (a) a septic tank, an effluent or a sullage disposal system, or
- (b) any sewer of a council,

And includes work of sanitary plumbing and work of house drainage.

Sludge: mainly organic semi-solid product produced by wastewater treatment processes.

Sludge wasting: the programmed and regular removal of sludge to reduce the sludge age. Removes old microbes that consume little organic material to create room for increased population of new microbes which will consume more organic material.

Soil absorption system: (includes leach drains, drain fields, absorption trenches, seepage beds and seepage pits) subsurface effluent application systems that rely on the capacity of the soil to accept, transmit and further treat the applied hydraulic load.

Sorption: the process or processes that cause a substance in solution to become attached to a solid.

Split system: wastewater management system in which multiple treatment and effluent application areas are used for different components of the wastewater. This can include a treatment device that accepts waste directly from the toilet and possibly kitchen, where treated wastewater is directed to an effluent application area; whilst the remainder of the wastewater is drained to another effluent application area through a sullage tank or greywater processing system.

Suspended solids (SS): in wastewater analysis: solids retained after filtration through a glass fibre filter paper followed by washing and drying at 105°C, or by centrifuging followed by washing and removal of the supernatant liquid; expressed in milligrams per litre (mg/L).

Total off-site wastewater management (total off-site management): management of untreated domestic wastewater in a centralised sewerage system. Includes sewage ejection pump stations (SEPS).

Total onsite wastewater management (total onsite management): treatment and application of all wastewater generated within a household, completely within the boundaries of the premises on which it was generated.

Trade waste: all liquid waste other than sewage of a domestic nature.

Treated sewage: (in these Guidelines) sewage that has received treatment via a human waste treatment device. Also known as effluent.

Treatment level - primary: processes and unit operations that remove suspended solids (organic and inorganic) from wastewater by sedimentation, floatation and anaerobic digestion processes.

Treatment level - secondary: processes and unit operations that follow primary treatment and are designed to remove biodegradable dissolved and colloidal organic matter by aerobic biological processes.

Treatment level - secondary (advanced): processes and unit operations that follow secondary treatment and includes biological transformation processes.

Treatment train: the sequence of compatible unit operations that connect the source of the wastewater to an intended application or recycling option.

Unit operations: refer to individual treatment processes or the physical facilities in which a physical, chemical and/ or biological process is made to occur for the purpose of removing or destroying contaminants of concern.

Vectors: insects or animals, such as flies, mosquitos or rodents, that are attracted to the putrescible organic material in wastewater and wastewater treatment systems, and that spread disease.

Waste (from LG Act):

(a) effluent, being any matter or thing, whether solid or liquid or a combination of solids and liquids, which is of a kind that may be removed from a human waste storage facility, sullage pit or grease trap, or from any holding tank or other container forming part of or used in connection with a human waste storage facility, sullage pit or grease trap.

Wastewater: waste transported by water, including human waste.

Waterbody: a body of surface water, permanent or intermittent, fresh, brackish or saline, including where the course has been artificially modified or diverted. This includes rivers, creeks, streams, lakes, lagoons, dams, wetlands, estuaries, bays, inlet or tidal waters (including the ocean).

Water recycling: the process of reusing reclaimed water for a beneficial purpose.

Water table: the level below which the ground is saturated with water. It is the surface where water pressure head is equal to atmospheric pressure.

Waterless composting toilet: (humus closet, biological toilet) waterless system that uses the principle of composting to break down human excreta to a humus-type material. The liquid fraction is evaporated or directed to an appropriate management system.

Wet composting toilet: treats all household wastewater and putrescible household organic solid wastes such as food waste. Uses the principle of aerobic composting to break down the solid waste; the liquid component is directed to an effluent application system after passing through the pile of solids.

Wisconsin mound: A constructed mound of select sand which provides both secondary treatment and land application on the same footprint. First developed and used in Wisconsin, USA.

Draft

Bibliography: References and Further Reading

ARTD Management and Research Consultants (2002) *Evaluation of the SepticSafe program: 1998 to June 2002*, ARTD, Sydney.

Advanced Enviro-Septic (2003) *Advanced Enviro-Septic Design and Installation Manual*.

Auckland Council (2021) *On-site Wastewater Management in the Auckland Region. GD2021/006*.

Australian Geomechanics Society (2007) *Australian Geoguide LR9 (effluent disposal)*.

Beavers PD and Gardner EA (1993) Prediction of virus transport through soils. *Australian Water and Wastewater Association, Technical Papers of the 15th Federal Convention*, Gold Coast, Australia, 18-23 April 1993 (Volume 2, pp 530-535).

Beggs RA, Hills DJ, Tchobanoglous G, and Hopmans JW, (2011). Fate of nitrogen for subsurface drip dispersal of effluent from small wastewater systems. *Journal of Contaminant Hydrology*, 126(1-2), pp.19-28.

Bishop A, Whitehead JH, Asquith B, (2007) Optimising mound designs – incorporating best practice and innovation, *On-Site '07 Conference*, Armidale.

Bounds TR (1988) *Glide Audit 1986-1987, summary of sludge and scum accumulation rates*, Douglas County Department of Public Works, Roseburg, Oregon.

Bounds TR (1995) Septic tank septage pumping intervals, *Proceedings of the 1994 American Institute of Agricultural Engineers*, Atlanta Georgia.

Bounds TR (1997) Design and Performance of septic tanks, Site characterisation and design of on-site systems ASTM STP 901, Bedinger MS, Johnson AI and Fleming JS (eds), *American Society for Testing Materials*, Philadelphia.

Brooks JL, Rock CA and Struchtemeyer RA (1984) Use of peat for on-site wastewater treatment: II field studies, *J. Environmental Quality*, 13, 524-530.

Bowman M (1996) *On-site tertiary treatment using Ecomax systems*. *Desalination*, 106(1-3), pp.305-310.

Byron Shire Council (2004) *Design guidelines for on-site sewage management for single households*, Byron Bay NSW.

Centre for Environmental Training and NSW Environment Protection Authority (2002) Course notes: *Package Wastewater Treatment Plant Training Course*, Centre for Environmental Training, Cardiff Heights.

Centre for Environmental Training (2002) Course notes: *Sand Filters and Mound Systems for On-site Wastewater Treatment*, Centre for Environmental Training, Cardiff Heights.

Converse JC and Tyler EJ (2000) Wisconsin mound soil absorption system: siting, design and construction manual, 15.24

Cote CM, Bristow KL, Charlesworth PB, Cook FJ and Thorburn PJ (2003). *Analysis of soil wetting and solute transport in subsurface trickle irrigation*. *Irrigation Science*, 22(3-4), pp.143-156.

Charles KJ, Ashbolt NJ, Roser DJ, McGuinness R and Deere DA (2004) *Effluent quality from 200 on-site sewage systems: Design values for guidelines*, International Water Association Small WE & WWTP (February 2004).

Crites R and Tchobanoglous G (1998) *Small and decentralised wastewater management systems*, McGraw-Hill, San Francisco, CA.

Cromer WC, Gardner EA and Beavers PD (2001) An improved viral die-off method for estimating setback distances [conference presentation], In *Proceedings of On-site'01 Conference: Advancing On-site Wastewater Systems*. Patterson RA and Johns MJ (Eds). Lanfax Laboratories, Armidale (pp. 15-27).

Cromer WC (2013) *Bottomless sand filters: notes for designers, installers and regulators*.

Davison L (2001) Constructed wetlands in on-site wastewater systems, *Proceedings of on-site '01 conference, "Advancing On-site Wastewater Systems"* Lanfax Laboratories, Armidale.

Davison L (2003) *Notes for reed bed workshop – 29th September 2003*, Southern Cross University, Lismore.

Davison L and Bayley M (2001) Treatment by reed bed and sand filter: results from a test facility, *Proceedings of On-site '01 Conference, "Advancing On-site Wastewater Systems"* Lanfax Laboratories, Armidale.

Davison L, Bayley M, Kohlenberg T and Craven J (2002) *Performance of reed beds and single pass sand filters with characterisation of domestic effluent: NSW North Coast - a research report*, Department of Local Government, Sydney.

Davison L, Headley T and Pratt K (2005) 'Aspects of design, structure, performance and operation of reed beds - eight years experience in north eastern New South Wales, Australia.' *Water Science and Technology* 51.10: pp 129-138.

Davison L and Schwizer B (2001) SepticSafe Technical Sheet, *Waterless composting toilets*, Department of Local Government, Sydney.

Department of Environment and Conservation (2004) *Environmental guidelines: use of effluent by irrigation*, DEC Sydney

Department of Land and Water Conservation (1998) *The constructed wetlands manual*, DLWC, Sydney.

Department of Land and Water Conservation (2000) *Soil and landscape issues in environmental impact assessment*, DLWC, Sydney.

Department of Local Government (2001) *The Easy Septic Guide*, DLG, Sydney.

Department of Local Government (2005) *2005 On-site sewage management survey – report on the findings*.

Department of Planning and Environment (2023) [eSPADE](https://www.environment.nsw.gov.au/eSpade2WebApp), accessed 19 January 2023. <https://www.environment.nsw.gov.au/eSpade2WebApp>

DPIE (Department of Planning, Industry and Environment) (2021) *Guide to writing conditions of consent*.

DPI (Department of Primary Industries) (2021a) NSW Oyster Industry Sustainable Aquaculture Strategy, Fourth Edition.

DPI (Department of Primary Industries) (2021b) *Soil acidity and liming*. 4th edn. <https://www.dpi.nsw.gov.au/agriculture/soils/guides/soil-acidity/soil-acidity-and-liming-2021-ac.19>

Eljen (2016) *GSF geotextile sand filter: Australia design & installation manual*.

Environment Protection Authority Victoria (2016) *Code of practice onsite wastewater management*, Publication 891.4, Victoria State Government.

Environment Protection Authority Victoria (2020) *Technical information for the Victorian guideline for water recycling*. Publication 1911.2 March 2021.

Feachem RG and Bradley DJ (1983) *Sanitation and disease health aspects of excreta and wastewater management*, World Bank/John Wiley & Sons, New York.

Geary PM and Pang L (2005) Determination of buffer distances from on-site wastewater systems, in *Proceedings of On-site '05 Conference, Performance Assessment for On-site Systems: Regulation, Operation and Monitoring*, 27-30 September 2005, Lanfax Laboratories, Armidale NSW, p.201-208.

Geary PM and Gardener EA (1996) On-site disposal of effluent, *Land management for urban development*, p291-319.

Global Rotomoulding (2018) *Reed bed installation instruction fact sheet*.

Gray JM and Chapman GA (2005) Feasibility assessment for on-site wastewater disposal, in *Proceedings of On-site '05 Conference, Performance Assessment for On-site Systems: Regulation, Operation and Monitoring*, 27-30 September 2005, Lanfax Laboratories, Armidale NSW, p.217-214.

Gunn RH, Beattie JA, Reid RE and van de Graaff RHM (1988) *Australian soil and land survey handbook - guidelines for conducting surveys*, Inkata Press, Australia.

Hassan G, Reneau RB, Hagedorn C, and Jantrania AR, (2008). *Modelling effluent distribution and nitrate transport through an on-site wastewater system*. *Journal of environmental quality*, 37(5), pp.1937-1948.

Hazelton P and Murphy B (2016) *Interpreting soil test results: What do all the numbers mean?* CSIRO publishing.

Headley T and Davison L (2003) Design models for the removal of BOD and Total Nitrogen in reed beds, *Proceedings of On-site '03 Conference "Future Directions for On-site Systems: Best Management Practice*, Lanfax Laboratories, Armidale.

Hoxley G and Dudding M (1994) Groundwater contamination by septic tank effluent: Two case studies in Victoria, Australia, *Water Down Under 94: Groundwater/ surface hydrology common interest papers; preprints of papers*, Institution of Engineers, Australia, pp145-152.

Hudson BJ (1999) *Scientific report: ballast water treatment program*, Department of Microbiology, Royal North Shore Hospital (Sydney University), Sydney.

Jelliffe PA (1999) Developments in determining critical lot density for the protection of water quality, *Proceedings of On-site '99 "Making On-site Systems Work"*, Lanfax Laboratories, Armidale.

Jelliffe PA (2000) Sustainable development density for on-site sewage management [conference presentation], *Australian Water Association Conference*, May 2000, Canberra.

Jenkins. JC (2019) *The humanure handbook, 4th edn*, Joseph Jenkins Inc, USA.

Kadlec RH and Knight RL (1996) *Treatment wetlands*, Lewis Publishers, Boca Raton.

Kadlec RH and Reddy KR (2001) Temperature effects in treatment wetlands, *Wat. Enviro. Res.*, **73**(5) 543-557.

Kayaalp M, Ho G, Mathew K and Newman PWG (1988) Phosphorus movement through sands modified by red mud, *Water*, '15, Australian Water Association, pp.26-29.

Landcom (2004) *Managing urban stormwater: soils and construction* Vol 1 4th ed.

Lismore City Council (2005) *The use of reed beds for the treatment of sewage & wastewater from domestic households*, Lismore NSW.

Martens DM (2001) *Sizing effluent disposal fields: balancing water and nutrients*, SepticSafe Technical Sheet, Department of Local Government, Sydney.

McKenzie NJ, Coughlan K and Cresswell HP (2002) *Soil physical measurement and interpretation for land evaluation, Australian soil and land survey handbook series Vol 5*, CSIRO Publishing, Melbourne.

Milford HB, McGaw AJE and Nixon KJ (2001) *Soil Data Entry Handbook for the NSW Soil and Land Information System (SALIS)*, 3rd Edn, NSW Dept of Land and Water Conservation, Sydney.

National Committee on Soil and Terrain (2009) *Australian soil and land survey field handbook* (3rd ed), CSIRO Publishing, Melbourne.

NIWA (National Institute of Water & Atmospheric Research (2011) *Guideline for the use of horizontal subsurface-flow constructed wetlands in on-site treatment of household wastewaters*. Prepared for Gisborne District Council, an Envirolink Project.

Northcote KH (1979) *A factual key for the recognition of Australian soils*, CSIRO, Rellim Technical Publications, Adelaide.

NSW DPIE (Department of Planning, Industry and Environment (2021) *Liquid trade waste management guidelines, for councils in regional NSW*, 2021

NSW Environment Protection Authority (2021) *EPA powers and notices: guideline for authorised officers and enforcement officers under the POEO Act 1997*.

NSW Environment Protection Authority (2000) *Use and disposal of biosolids products*.

NSW Health (2000) *Greywater Reuse in Single Sewered Domestic Premises* NSW Health, Sydney.

NSW Health (2005) *Domestic Greywater Treatment Systems Accreditation Guideline*, NSW Health, Sydney.

NSW Health (2010) *Waterless Composting Toilets (WCT) Accreditation Guideline*.

NSW Health (2017) *Advisory Note 1 Exemption of Sewage Management Facilities from Accreditation*. NSW Health, Sydney.

NSW Health (2017) *Advisory Note 2 Accreditation Guidelines for Sewage Management Facilities*. NSW Health, Sydney.

NSW Health (2017) *Advisory Note 3 Destruction, Removal or Reuse of Septic Tanks, Collection Wells, Aerated Wastewater Treatment Systems (AWTS) and other Sewage Management Facilities (SMF)*. NSW Health, Sydney.

NSW Health (2017) *Advisory Note 4 Recommended Final Uses of Effluent based on the Type of Treatment*. NSW Health, Sydney.

NSW Health (2018) *Advisory Note 5 Servicing of Single Domestic Secondary Treatment Sewage Management Facilities (SMF)*. NSW Health, Sydney.

NSW Health (2021) *Advisory Note 6 Passive Disposal Systems (PDS). Single Domestic On-site Wastewater Management*. NSW Health, Sydney.

NSW Health (2021) *Advisory Note 7 Greywater Processing Devices (GPD). Single Domestic On-site Wastewater Management*. NSW Health, Sydney.

NSW Health (2021) *Advisory Note 8 Floods and On-site Wastewater Management Systems*. NSW Health, Sydney.

NSW Health (2021) *Advisory Note 9 Bushfire and On-site Wastewater Management Systems*. NSW Health, Sydney.

NSW Ministry of Health (2016) *Sewage Management Facility Vessel Accreditation Guideline*, NSW Health, Sydney.

- NSW Ministry of Health (2018) *Secondary Treatment System Accreditation Guideline 2018*.
- NSW Ombudsman (2015a) Annexure 1 Model compliance and enforcement model policy.
- NSW Ombudsman (2015b) Guidelines Enforcement guidelines for councils.
- Office of Environment and Heritage NSW (2016) eSPADE, user manual for version 2.0, Office of Environment and Heritage NSW, Sydney.
- Patterson RA (2001) Phosphorus sorption for on-site wastewater assessments [conference presentation], *Proceedings of On-site '01 Conference "Advancing On-site Wastewater Systems"* Lanfax Laboratories, Armidale, (pp 25-27).
- Patterson RA (2006) *Consideration of Soil Salinity When Assessing Land Application of Effluent*, SepticSafe Technical Sheet Reference 01(6), DLG Sydney.
- Patterson RA (2006) *Evapotranspiration bed designs for inland areas*. Technical Sheet Reference 5(15).
- Rawlinson LV (1994) *Review of wastewater systems*, Report prepared for Environment Protection Authority, NSW, Southern Tablelands Region.
- Rayment GE and Higginson FR (1992) *Australian laboratory handbook of soil and water chemical methods*, Inkata Press Pty Ltd, Melbourne.
- Rayment GE and Lyons DJ (2011) *Soil chemical methods: Australasia* (Vol. 3). CSIRO publishing.
- Reed SC, Crites RW and Middlebrooks EJ (1995) *Natural Systems for Waste Management and Treatment*, McGraw Hill, NY.
- Robinson V (2000) A new technique for the treatment of wastewater, *Enviro 2000 Ozwaste Conference*, Darling Harbour, Sydney, Sydney, 10-12 April, 2000.
- Schijven JF and Hassanizadeh SM (2000) Removal of viruses by soil passage: Overview of modelling, processes, and parameters, *Critical Reviews in Environmental Science and Technology* **30**(1): 49-127.
- Siegrist RL (2017) *Decentralized Water Reclamation Engineering*, Springer.
- Speight JG (1990) *Landform*, In: McDonald et al (eds): *Australian soil and land survey field handbook* (2nd edn), 9-57. Inkata Press, Melbourne.
- Standards Australia (2008a) *AS/NZS 1546.1:2008 On-site domestic wastewater treatment units Part 1 Septic Tanks*. Standards Australia.
- Standards Australia (2008b) *AS/NZS 1546.2:2008 On-site domestic wastewater treatment units Part 2: Waterless composting toilets*. Standards Australia.
- Standards Australia (2012) *AS/NZS1547:2012 On-site Domestic Wastewater Management*, Standards Australia.
- Standards Australia (2016) *AS1546.4:2016 On-site domestic wastewater treatment units Part 4 Domestic greywater treatment systems*, Standards Australia.
- Standards Australia (2017a) *AS 1289.3.8.1:2017 Methods of Testing soils for engineering purposes. Soil Classification Tests – Dispersion – Determination of Emerson class number of a soil*, Standards Australia.
- Standards Australia (2017b) *AS1546.3:2017 On-site domestic wastewater treatment units Part 3 Secondary treatment systems*, Standards Australia.
- Tchobanoglous G and Burton FL (1991) *Wastewater Engineering: Treatment, Disposal, and Re-use*, 3rd Edn, Metcalf & Eddy Inc, McGraw Hill, New York.
- Timms W, Glamour W and Pells S (2005) Groundwater quality impacts of on-site effluent disposal [conference presentation], *Proceedings of On-site '05 Conference, Performance Assessment for On-site Systems: Regulation, Operation and Monitoring*, 27-30 September 2005, Lanfax Laboratories, Armidale NSW, p.367-374.
- Tyler EJ (2001) Hydraulic wastewater loading rates to soil, *On-site wastewater treatment* [conference presentation], *Proceedings of the Ninth National Symposium on Individual and Small Community Sewage Systems*, Fort Worth, Texas, March 2001, American Society of Agricultural Engineers.
- United Nations Environment Program (2002) *International Source Book on Environmentally Sound Technologies for Wastewater and Stormwater Management*, IETC Technical Publication Series 20, United Nations Environment Program, Osaka, Shiga.
- USEPA (United States Environmental Protection Agency) (1992) *Wastewater Treatment/Disposal for Small Communities* EPA/625/R92/005.
- USEPA (United States Environmental Protection Agency) (2000) *Wastewater Technology Fact Sheet Package Plants*.

- USEPA (United States Environmental Protection Agency) (2002) *Onsite Wastewater Treatment Systems Manual*.
- USEPA (United States Environmental Protection Agency) (2012) *Guidelines for Water Reuse*.
- van de Graff R and Patterson RA (2001) Explaining the mysteries of salinity, sodicity, SAR, and ESP in on-site practice [conference presentation], *Proceedings of On-site '01 Conference "Advancing On-site Wastewater Systems"* Lanfax Laboratories, Armidale.
- WaterNSW (2023a) *Designing and installing on-site wastewater systems: A WaterNSW Current Recommended Practice*.
- WaterNSW (2023b) *Water Sensitive Design Guide for Rural Residential Subdivisions: A WaterNSW Current Recommended Practice*.
- WaterNSW (2022) *Neutral or beneficial effect on water quality assessment tool. Consultant and consultant administrators, user guide*.
- West SM (2003) *Onsite and Decentralised Sewage Treatment Reuse and Management Systems in Northern Europe and the USA (Unpublished)*.
- Yates MV and Yates SR (1988) Modelling microbial fate in the subsurface environment, *CRC Critical Reviews in Environmental Control* 17(4): 307-344.

Appendix 1:

Model Site Report

Appendix 1. Model Site Report

1.0 Site Evaluator(s)	
Name:	
Company/ Agency:	
Address:	
Tel:	
E-mail:	
Date:	
2.0 Site Information (Desktop evaluation)	
Site address:	
Local Government Area:	Lot/ DP:
Client/ Owner/ Developer:	
Address:	
Tel:	
Email:	
Site Description (General):	
Area of lot, LEP zoning, location in landscape, topography, slope, buildings, services and neighbouring properties uses:	
Proposed Development (new or renovated buildings/ planned improvements):	
Map name and scale (topographic/ orthophoto):	
Site Plan and photograph(s) of site and soils:	
Are the following features marked on Site Plan:	
Location of OWMS components (treatment tank, plumbing, EAA) and any existing components:	OWMS
Waterways, drainage lines and dams:	
Stands of trees/ shrubs:	
Bores/ wells:	
Buildings/ driveways/ pools/ fences (existing and proposed):	
Other sensitive receptors:	
North arrow, scale, slope (gradient and direction), lot boundaries, borehole locations, buffers to sensitive receptors:	
Available EAA and excluded areas:	
2.1 Geology (from geological map)	

2.2 Soil Landscape (from soil landscape map)			
2.3 Climate:			
Data source:			
Average annual rainfall:	mm		
Average annual evaporation:	mm		
Intensity/ seasonal variation:			
2.4 Intended water supply source and design flows			
Reticulated	Roof collection of rainwater	Bore/ well/ dam back-up	
Water saving devices (confirm star rating):	None	3-star	4-star or greater
Number of bedrooms:			
Total design water use (derived per bedroom) (L/day):			
2.5 Existing local onsite systems			
Common neighbouring system:			
Typical performance/ problems evident:			
2.6 Discuss owner preference:			
2.7 Registered groundwater bores within 100m (use/ details):			
2.8 Sensitive receptors in local area (drinking water catchment/ vulnerable environments/ aquaculture/ food crops):			
2.9 Hazard mapping (flood potential/ bushfire/ acid sulphate soils/ geotechnical hazards):			

3.0 Site Evaluation	
Date:	
Weather on day of site evaluation:	
Weather in week preceding site evaluation:	
3.1 Existing OSMS type/ condition/ dimensions/ capacity (if any):	
Existing treatment tank/s (septic/ AWTS/ GT):	
Existing EAA (type/ condition/ size/ layout)	
3.2 Site characteristics and limitations (at EAA)	
Slope (gradient (%)) and direction:	
Topographic position of EAA/ landform:	
Ground cover/ vegetation:	
Exposure – aspect/ shading	
Surface and subsurface drainage (flow paths towards waterways/ sensitive features)	

Run-on and seepage:
Erosion potential (slope/ soil erosivity/ exposure):
Fill (presence/ stability):
Surface rocks (presence/ proximity):
Sensitive receptors:
3.3 Previous use of EAA and degree of soil disturbance:
Fill, compaction, contamination:
3.4 Site stability:
Expert assessment required: Yes/ No
If yes, attach slope stability report and risk assessment
3.5 Photograph of EAA attached: Yes/ No

4.0 Soil Assessment (One sheet required for each soil test pit or borehole)												
Client:						Date:						
Lot Number:				D.P.:				Grid reference:				
Location of test pits or boreholes to be marked on site plan (plan attached)						GPS reference coordinates						
Borehole number:												
Slope:				Landscape position:				Parent material:				
AHD (m):				Surface condition:				Vegetation:				
Indicative surface drainage:						Indicative subsurface drainage:						
Depth to bedrock/ hard pan (m):						Depth to soil watertable (seasonal/ permanent) (m):						
Layer	Lower depth mm	Horizon	Colour (moist) & mottles	Field texture	Structure	Moisture	Soil category#	Sample I.D.	Indicative permeability (mm/day)	Coarse Fragments	Other Comments	
1												
2												
3												
4												
4.1 Additional field/ laboratory test results (as applicable)												
	Horizon 1			Horizon 2			Horizon 3			Horizon 4		
pH: (1:5 soil:water)												
Electrical conductivity (dS/m) (1:5 soil:water)												
Emerson class (EAT)												
Exchangeable sodium percentage (%)												

Phosphorus sorption capacity (mg/kg)				
Other				
NOTES <ul style="list-style-type: none"> • Only the first part of the Emerson Aggregate test is required • Soil Category refers to soil textures as outlined in Table 4-6 				

Draft

5.0 General comments

5.1 Environmental and health issues of significance identified in site and soil assessment (moderate and major limitation) and mitigation measures proposed to offset limitations:

Feature	Limitation identified	Mitigation measures

5.2 Buffer distances available to:

Feature	Required buffer (m)	Available buffer (m)
Permanent watercourse (river, creek, lake):		
Intermittent watercourse (gully, drainage line, dam):		
Groundwater bore/ well		
Site boundaries:		
Buildings:		
Recreation areas (pool):		
In-ground water tank:		
Retaining wall/ embankment:		
Groundwater:		
Hardpan/ bedrock:		
Sensitive receptors:		

5.3 Land area available (site size - constrained areas) (m²):

5.4 System selection

Consideration of connection to centralised sewerage system/ distance:

Type of treatment system(s) best suited to site:

Rationale:

Type of effluent application option(s) best suited to site:

Rationale:

Recommended design loading rate:

Design wastewater loading: litres per day (from 2.4)

Design loading rate: litres per square metre per day

Rationale:
Total land area required for system and effluent application option:
Is there sufficient EAA for the system selected? Yes/ No
Is there sufficient land area for additional/ reserve EAA? Yes/ No
If so, what additional EAA is available? m ²
5.5 Other comments/ special design considerations required:

Draft

Appendix 2:

Model Approval to Install/Alter Conditions

Appendix 2. Model Approval to Install/ Alter Conditions

Note:

These model conditions are provided as a guide for use by local councils. Where a condition is not relevant to the subject approval, it is recommended that the condition is modified to suit the approval or the condition deleted. Update each condition as required where a referenced piece of legislation or regulation has been updated.

Conditions should be clear, measurable, consistent and written in plain English and be used to ensure compliance and be enforceable as per NSW DPIE (2021) *Guide to writing conditions of consent*.

Notice of Determination of an Application – Section 68 of the *Local Government Act 1993*

Provide approval number, owner details, site details, approval commencement and expiry dates.

A2.1. Schedule of Conditions

A2.1.1. General Conditions

1. The proposed activity is approved subject to all works being undertaken in accordance with the Wastewater Management Report, prepared by _____, dated _____ and the following **Schedule of Conditions**. In the event of any inconsistency between conditions of this approval and the details referred to above, the conditions of this approval prevail.
2. The wastewater management system is to be installed and maintained as appropriate in accordance with the principles of “*Environment & Health Protection Guidelines: Onsite Wastewater Management*” (OLG 2023), “AS/NZS1547:2012 On-site Domestic Wastewater Management” (SAI) and this approval to install/ alter the system and the approved wastewater management report. No alterations or additions are permitted without approval from Council.
3. Where this approval relates to the failure of an existing Onsite Wastewater Management System (OWMS) and this approval and associated works relate to proposed measures to be undertaken to address the failed OWMS. The approved works must be completed within _____ days from the date of this approval, subject to any further agreed extension of time subsequently granted by Council as the circumstance may warrant.

Reason: Urgent works are required to upgrade a failing OWMS.

4. This approval must only be read and applied in conjunction with a Development Consent/ Construction Certificate or a Complying Development Certificate issued in respect to this specific development. If these development approvals contain variations from the details associated with this approval, then the applicant must apply and obtain an amendment to this approval prior to undertaking any work associated with the installation of the Onsite Wastewater Management System.

Reason: Approval relates to Development Consent/ Construction Certificate or Complying Development Certificate

5. All plumbing and drainage work shall be carried out by a suitably licensed plumber or drainer and in accordance with Australian Standard AS3500 and NSW variations.

- Note: It is the applicant's responsibility to notify the plumber/ drainer of all conditions of approval.
 - The following work must be inspected and approved by Council: Sewer drainage and effluent disposal area prior to the backfilling of trenches.
 - Note: Generally, 48 hours prior notice is required to permit inspection.
6. All electrical work must be carried out by a suitably licensed electrician or trade person and in accordance with the relevant provisions of AS/NZS3000.
 7. Any accredited sewage management facility shall be supplied, constructed and installed in accordance with the certificate of accreditation issued by the Secretary of the NSW Ministry of Health.
 8. [Add in at this point the conditions (if any) of the relevant SMF guidelines and any certificate of accreditation issued by the Secretary of the Ministry of Health in respect of the plans or designs for any components of the sewage management facilities installed and operated on the premises that must be complied with].
 9. An installation certificate is to be submitted to Council by the licensed plumber/ installer within two (2) days of completing the work stating that the onsite wastewater management system has been installed in accordance with the approved design, this approval, Australian Standard AS/NZS1547:2012 and Australian Standard AS 3500.
 10. The facility is not to be used (or used as altered) until the Council has given the applicant an approval notice in writing that it is satisfied that the facility has been installed, constructed or altered in substantial accordance with the approval. This approval notice will be in the form of an Approval to Operate, issued to the owner.
 11. The onsite wastewater management system must be completed prior to occupation of any dwelling subject to an associated development approval. This is to include associated landscaping and planting for the OWMS.
 12. No alterations or additions to the OWMS or the associated buildings are permitted without written approval from Council.
 13. The sewage management facility must, if it is intended to be a permanent fixture, be adequately anchored to prevent movement.
 14. Liquid trade wastes, whether generated on the premises or not, must not be discharged into the onsite wastewater management system unless approved by Council in writing.
 15. The existing human sewage treatment facilities shall be decommissioned in accordance with NSW Health Advisory Note 3: 2017 Destruction, removal or reuse of septic tanks, collection wells, Aerated Wastewater Treatment Systems (AWTS) and other Sewage Management Facilities (SMF), or subsequently revised version.
 16. The treatment system and surrounding development shall be installed in such a way to allow suitable access for monitoring and maintenance, including regular checks and pump-out.
Reason: Physical access to the treatment tank and OWMS components can become constrained by development surrounding and above the components.
 17. An OWMS must not discharge into any watercourse or onto any land other than its approved Effluent Application Area (EAA) and by the approved method of application.
 18. The OWMS must not be installed in such a way that it can contaminate any domestic water supply.
 19. The treatment system and EAA must be protected from possible damage by vehicles and stock to the satisfaction of Council.

Reason: The treatment system, underground pipework and EAA can be damaged by crushing or compaction.

20. The EAA must be maintained as a permanent, dedicated area. Buildings, driveways, concrete, tennis courts, swimming pools, garden beds, vegetable gardens, large trees and the like must not be placed in or on the EAA.

Reason: To preserve the EAA purely for effluent application and protect its performance.

21. The EAA must not be used to grow vegetables or fruit for human consumption. No wastewater, effluent or greywater from the OWMS shall be used to grow vegetables or fruit for human consumption.

22. Signage must be installed to indicate that effluent is being managed in the EAA.

A2.1.2. Collection Well Conditions

23. The capacity of the collection well shall be at least _____ litres.

Reason: To ensure the system adequately caters for the likely maximum demand.

24. That a suitable audible and visual high-water alarm is installed in the collection well. The level of the high-water alarm is to be set to provide at least two (2) days warning prior to the tank being full.

Reason: To prevent overflow and pollution.

25. A graduated dipstick or measuring system shall be provided to the collection well. The highest graduation must indicate when the collection well is full.

26. The collection well shall only be pumped-out by a licensed liquid waste collection contractor and disposed of in a suitably licensed facility prior to becoming full.

27. A non-return valve shall be provided to the outlet of the collection-well and a manual control valve on the end of the effluent line adjacent to the property boundary.

Reason: To prevent back-flow into the tank and surcharging at the end of the effluent line.

28. The pump-out line shall be suitable suction line of 50mm in diameter and terminated 1 metre from the property boundary with a cap effectively secured by a chain.

Reason: To ensure the pump-out line is vermin proof and compatible with the pump-out contractor's fittings.

29. If required, the collection well shall be fitted with a submersible booster pump with a suitable on/ off switch located directly adjacent to the 50mm pump-out line within 1 metre of the property boundary.

Reason: To ensure there is sufficient pressure to enable transport of the effluent to the pump-out tanker on a site where pumper suction would not be sufficient.

A2.1.3. Pump to Sewer Conditions

30. The Sewage Ejection Pump Station (SEPS) shall be installed in such a position to allow suitable access for maintenance.

31. That the conditions stipulated by the _____ (sewer authority) in its letter of _____ (date) are complied with.

32. That suitable audible and visual alarms are installed in the SEPS to provide warning of high-water prior to the tank being full and of pump failure.

33. Where the SEPS contains only one (1) pump and less than one (1) day's storage capacity within the unit following a high-water alarm, a collection well with at least two (2) days storage capacity shall be installed in case of pump failure.

A2.1.4. Secondary Treatment System Conditions

34. The installation of the STS should be inspected and checked by the manufacturer or the manufacturer's agent. The manufacturer or their agent is to certify that the system has been installed and commissioned in accordance with its design, conditions of accreditation and any additional requirements of Council.
35. Either the owner or occupier of a premises shall enter into an annual service contract with a service contractor or company acceptable to the local authority.
36. The STS shall be serviced and maintained at regular intervals in accordance with the details set out in the manufacturer's service manual by a service contractor or company acceptable to the local authority.
37. All irrigation pipework and fittings must not use standard household hose fittings or sprinklers or be capable of being connected to the mains water supply.
38. All distribution lines of the system must be buried to a minimum depth of 0.1m below finished ground level.
39. The irrigation system must be operated in such a way as to prevent any run-off or spray drift of effluent from the EAA.
40. Within the effluent irrigation area there must be at least two warning signs that comply with AS 1319-1994 – "Safety signs for the occupational environment" and have:
1. a green background
 2. 20mm high capital lettering in black or white, and
 3. the words 'RECLAIMED EFFLUENT - NOT FOR DRINKING - AVOID CONTACT'.

Reason: To preserve the health of occupants and visitors to the site by making it clear that contact with reclaimed effluent is not advisable.

41. No surface irrigation is permitted unless approved by Council and the STS is maintained and operated in accordance with the conditions of accreditation issued for the system by the NSW Ministry of Health and the conditions of this approval.
42. If surface irrigation is approved, a sprinkler system with a plume of coarse droplets at a height of not more than 0.4m is to be installed, with the supply lined buried 0.1m below ground.

Reason: To minimise spray drift onto other properties and parts of the allotment, and to protect the supply line from freezing.

A2.1.5. Waterless Composting Toilet System Conditions

43. The installation of the Waterless Composting Toilet System (WCTS) should be inspected and checked by the manufacturer or the manufacturer's agent. The manufacturer or their agent is to certify that they system has been installed and commissioned in accordance with its design, conditions of accreditation and any additional requirements of Council.
44. Maintenance of the WCTS is to be completed in accordance with the manufacturer's operation manual. The owner/ operator of the system is to obtain an operation and maintenance manual from the manufacturer.

Reason: To ensure the owner/ operator has the necessary information to carry out basic maintenance.

45. Composted waste material from the WCTS is to be disposed of by burial within the confines of the premises in soil, which is not intended to be used for at least three (3) months for the cultivation of food for human consumption. The minimum cover of soil over the deposited compost must be 100mm.
46. A permanent notice with basic instructions must be fixed to the facility in a prominent position. The permanent notice must include provisions for recording the date of commissioning and the last time compost waste was removed.
47. The fan fitted to the air vent must be installed in such a manner that it operates continuously, with easy access being supplied for repairs or replacement of the fan.

Reason: To keep the drainage bed and compost pile aerated.

48. No kitchen sullage or greywater is to be disposed of through the WCTS.
49. Liquid from the WCTS is to be directed to the approved EAA.

A2.1.6. Wet Composting System (Worm Farm) Conditions

50. The installation of the Wet Composting System (WCS) should be inspected and checked by the manufacturer or the manufacturer's agent. The manufacturer or their agent is to certify that they system has been installed and commissioned in accordance with its design, conditions of accreditation and any additional requirements of Council.
51. Maintenance of the WCS is to be completed in accordance with the manufacturer's operation manual. The owner/ operator of the system must obtain an operation and maintenance manual from the manufacturer.

Reason: To ensure the owner/ operator has the necessary information to carry out basic maintenance.

52. Composted waste material from the WCS is to be disposed of by burial within the confines of the premises in soil, which is not intended to be used for at least three (3) months for the cultivation of food for human consumption. The minimum cover of soil over the deposited compost must be 100mm.
53. A permanent notice with basic instructions must be fixed to the facility in a prominent position. The permanent notice must include provisions for recording the date of commissioning and the last time compost waste was removed.
54. The fan fitted to the exhaust duct or the wind ventilator above the vent stack must be installed in such a manner that it operates continuously, with easy access being supplied for repairs or replacement of the fan or wind ventilator.

Reason: To keep the drainage bed and compost pile aerated.

55. Where a pump is installed in the system, a suitable audible and visual high-water alarm shall be installed and maintained in an operational condition to provide warning of a pump failure.

A2.1.7. Sand Filter and Reed Bed Conditions

56. If reeds and vegetation are part of the design, these must be maintained. They must be periodically cut back and replaced if plants die.
57. The sides of the sand filter or reed bed must be 0.1m above the surrounding ground surface to stop inflow of overland water flows.
58. The sand filter and reed beds shall be installed in a water-tight condition, including any inlet and outlet pipes.

A2.1.8. Wisconsin Sand Mound Conditions

59. Dosing of the Wisconsin Sand Mound (“mound”) should be small frequent doses, generally no more than 100L per dose.
60. Grass cover shall be established and maintained over the mound.

Reason: To protect the mound surface from erosion, provide evapotranspiration and prevent mulching and nutrient retention.

A2.1.9. Greywater Treatment or Diversion Device Conditions

61. Maintenance of any associated greywater diversion or treatment system to meet the performance standards of section 75A(2) of the Local Government (General) Regulation 2021 (NSW) and the Plumbing Code of Australia.
62. The filter installed in the greywater diversion system shall be regularly checked and cleaned out as required to maintain adequate filtration and flow through the greywater diversion device.
63. The greywater sub-surface irrigation area must be maintained by the owner or operator. This includes pipework, fittings and irrigation lines and vegetation.

A2.1.10. Greywater Processing Device Conditions

64. The Greywater Processing Device (GPD) must be installed to comply with the Plumbing Code of Australia.
65. The GPD must be installed by a licensed plumber who is authorised by the manufacturer or supplier.
66. The GPD must be serviced at two (2) yearly intervals by a service agent authorised by the manufacturer or supplier.
67. The GPD is installed such that the vessel is not exposed to direct sunlight.
68. The GPD must only receive greywater from a shower, bath or washing machine rinse water. Greywater from the kitchen, dishwasher, spa bath and laundry tub are excluded. No wastewater from a toilet or other ablution fixture is permitted. No solids are to be discharged to the GPD.
69. The owner and occupier of the premises is to be educated and has received an owner’s manual about limiting contamination of the greywater. This includes solid materials, chemicals, pharmaceuticals, paint residues, hair dye, bleach and disinfectants being strictly excluded.
70. Provided it achieves the required standard of treatment, the processed greywater from the GPD may be reused for toilet flushing, washing machine and garden purposes, provided either sub-surface irrigation is practiced, or a fixed, low pressure coarse spray is used. The treated greywater is not to be used for car washing or topping up swimming pools.
71. The installation of the GPD complies with Section 36 of the Local Government (General) Regulation 2021.
72. The GPD is to be connected to the approved OWMS to allow greywater flows to be redirected to the OWMS when required.

A2.1.11. Advisory Notes:

Reasons for Conditions

The reasons for the imposition of the above conditions are:

- To ensure that the onsite wastewater management system will have a neutral or beneficial effect on water quality, that it will be sustainable over the long term and will not have detrimental impacts on the public health and the environment.
- To comply with AS/NZS1547:2012 On-site Domestic Wastewater Management.
- To comply with Section 34 of the Local Government (General) Regulation 2021.

Draft

Appendix 3:

Model Approval to Operate Conditions

Appendix 3. Model Approval to Operate Conditions

Note:

These model conditions are provided as a guide for use by local councils. Where a condition is not relevant to the subject approval, it is recommended that the condition is modified to suit the approval or the condition deleted. Update each condition as required where a referenced piece of legislation or regulation has been updated.

Conditions should be clear, measurable, consistent and written in plain English and be used to ensure compliance and be enforceable as per NSW DPIE (2021) *Guide to writing conditions of consent*.

Notice of Determination of an Application – Section 68 of the *Local Government Act 1993*

Provide approval number, owner details, site details, approval commencement and expiry dates.

A3.1. Schedule of Conditions

A3.1.1. General Conditions

1. This Onsite Wastewater Management System (OWMS) has been assessed as being in the _____ risk category in accordance with Council's Onsite Wastewater Management Strategy. The owner/ operator shall allow Council to inspect the system to ensure it complies with this approval at least every _____ years. A fee will be charged for this inspection in accordance with Council's updated annual Fees & Charges.
2. This Approval to Operate is valid until the date of expiry on this Approval, or until renewal fees are unpaid, or the system is altered, or the associated buildings are altered, or the system does not satisfactorily pass a council inspection, or the property changes ownership.

Reason: As the Regulatory Authority, Council has a responsibility to ensure systems continue to operate efficiently.

3. The OWMS shall be operated in accordance with the conditions of any Approval to Install or Modify granted by the Council for the system, unless that approval has been revoked by the Council.
4. No alterations or additions to the OWMS or the associated buildings are permitted without written approval from Council.

Reason: To ensure that the designed and approved system is retained, and that the safety and effectiveness of the system is not diminished by modifications carried out. Required in accordance with the Local Government Act.

5. The OWMS must be operated in a manner that achieves the following performance standards of the Local Government (General) Regulation 2021:
 - (a) the prevention of the spread of disease by micro-organisms,
 - (b) the prevention of the spread of foul odours,
 - (c) the prevention of contamination of water,
 - (d) the prevention of degradation of soil and vegetation,
 - (e) the discouragement of insects and vermin,
 - (f) ensuring that persons do not come into contact with untreated sewage or effluent (whether treated or not) in their ordinary activities on the premises concerned,

- (g) the minimisation of any adverse impacts on the amenity of the premises and surrounding lands,
- (h) if appropriate, provision for the re-use of resources (including nutrients, organic matter and water).
6. The OWMS must be operated in accordance with the relevant operating specifications and procedures (if any) for the sewage management facilities used for the purpose.
 7. The OWMS must be operated and maintained so as to allow the removal of any treated sewage (and any by-product of any sewage) in a safe and sanitary manner.
 8. The sewage management facilities used in the operation of the system must be maintained in a sanitary condition and must be operated in accordance with the relevant requirements of the Local Government (General) Regulation 2021.
 9. A OWMS must not discharge into any watercourse or onto any land other than its approved Effluent Application Area (EAA) and by the approved method of application.
 10. [Add in at this point the conditions (if any) of the relevant SMF guidelines and any certificate of accreditation issued by the Secretary of the Ministry of Health in respect of the plans or designs for any components of the sewage management facilities installed and operated on the premises that must be complied with].
 11. The person operating the OWMS must provide details of the way in which it is operated, and evidence of compliance with the relevant requirements of the Local Government (General) Regulation 2021 and of the conditions of the approval, whenever the Council reasonably requires the person to do so.
 12. The OWMS must be maintained in such a way that it cannot contaminate any domestic water supply.
 13. Liquid trade wastes, whether generated on the premises or not, must not be discharged into the OWMS unless approved by Council in writing.
 14. The treatment system and surrounding development shall be maintained in such a way to allow suitable access for monitoring and maintenance, including regular checks and pump-out.
Reason: Physical access to the treatment tank and OWMS components can become constrained by development surrounding and above the components.
 15. Sludge and solids build-up in the sewage management facility shall be monitored regularly using an appropriate device. Pump-out shall be arranged when required to prevent damage to the downstream processes.
Reason: If the sludge/ scum levels are high or the sludge and/ or sum levels are near the base of the inlet or outlet T-piece of the sewage management facility, there is a greater risk of solids passing downstream and clogging the EAA.
 16. Wastewater, septage, sludge and effluent are only to be removed from the approved OWMS by a licensed liquid waste collection contractor and disposed of in a suitably licensed facility.
 17. Receipts for pump out, service and repairs to the system should be retained and provided to Council if they are requested.
 18. The treatment system shall be maintained in an operational condition, with any gaps or cracks sealed and repaired to prevent access by stormwater, insects and vermin.
 19. The treatment system and EAA must be protected from possible damage by vehicles and stock to the satisfaction of Council.

Reason: The treatment system and EAA can be damaged by crushing or compaction.

20. The EAA must be maintained as a permanent, dedicated area. Buildings, driveways, concrete, tennis courts, swimming pools, garden beds, vegetable gardens, large trees and the like must not be placed in or on the EAA.

Reason: To preserve the EAA purely for effluent application and protect its performance.

21. The EAA must not be used to grow vegetables or fruit for human consumption. No wastewater, effluent or greywater from the OWMS shall be used to grow vegetables or fruit for human consumption.
22. Vegetation on the EAA should be trimmed regularly and trimmed vegetation should be removed from the EAA.

Reason: To reduce mulch build-up and nutrient build-up in the EAA, which reduces its performance.

23. Signage must be installed to indicate that effluent is being managed in the EAA.
24. All stormwater collected upslope of the EAA is to be diverted away from any EAA, with provision for energy dissipation at the outlet to prevent scouring or erosion. The stormwater diversion should be maintained in an operational condition. Stormwater seepage must not be directed onto a neighbouring property.

Reason: To limit additional moisture in the EAA, which reduces its performance.

25. Council must be notified of any instance of failure of the OWMS that may result in a pollution event being caused or a threat to public health.

Reason: To enable Council to take appropriate action to reduce the level of risk posed.

26. The allotments on which the building, the sewage management facility, and the EAA are situated shall be maintained in one ownership and are not to be separately disposed of whilst the OWMS is in use.

A3.1.2. Septic Tank Conditions

27. The lid, tank, inlet and outlet T-pieces and baffle in the septic tank shall be maintained in operational condition and any leaks or gaps sealed and repaired.
28. The outlet filter shall be checked regularly and excess biofilm and solids washed off into a bucket or directly into the inlet of the septic tank.

A3.1.3. Collection Well Pump-out System Conditions

29. That a suitable audible and visual high-water alarm is maintained in the collection well. The level of the high-water alarm is to be set to provide at least two (2) days warning prior to the tank being full or at 80% capacity of the collection well, whichever is the smaller volume of liquid in the tank.

Reason: To prevent overflow and pollution.

30. A graduated dipstick or measuring system shall be maintained in the collection well. The highest graduation must indicate when the collection well is full.
31. The collection well shall only be pumped-out, prior to becoming full, by a licensed liquid waste collection contractor and disposed of in a suitably licensed facility.
32. A non-return valve shall be maintained in the outlet of the collection-well and a manual control valve on the end of the effluent line adjacent to the property boundary.

Reason: To prevent back-flow into the tank and surcharging at the end of the effluent line.

33. If required, the collection well shall have a submersible booster pump with a suitable on/ off switch located directly adjacent to the 50mm pump-out line within 1 metre of the property boundary.

Reason: To ensure there is sufficient pressure to enable transport of the effluent to the pump-out tanker on a site where pumper suction would not be sufficient, and for the safe operation of the pump by the operator.

A3.1.4. Pump to Sewer Conditions

34. That the conditions stipulated by the _____ (sewer authority) in its letter of _____ (date) are complied with.
35. That suitable audible and visual alarms are maintained in the SEPS to provide warning of high-water prior to the tank being full and of pump failure.
36. Where the Sewage Ejection Pump Station (SEPS) contains only one (1) pump and less than one (1) day's storage capacity within the unit following a high-water alarm, a suitable collection well shall be installed in case of pump failure.

A3.1.5. Secondary Treatment System Conditions

37. Either the owner or occupier of a premises shall enter into an annual service contract with a service contractor or company acceptable to the local authority.
38. The STS shall be serviced and maintained at regular intervals in accordance with the details set out in the manufacturer's service manual by a service contractor or company acceptable to the local authority.
39. A suitable service report is to be provided to the Council within fourteen (14) days of the service.
40. Change in the service contractor is to be immediately notified in writing to Council.
41. All irrigation pipework and fittings must not use standard household hose fittings or sprinklers or be capable of being connected to the mains water supply.
42. The irrigation system must be operated in such a way as to prevent any run-off or spray drift of effluent from the EAA.
43. Within the effluent irrigation area there must be at least two warning signs that comply with AS 1319-1994 – "Safety signs for the occupational environment" and have:
- A green background
 - 20mm high capital lettering in black or white, and
 - The words 'RECLAIMED EFFLUENT - NOT FOR DRINKING - AVOID CONTACT'.

Reason: To preserve the health of occupants and visitors to the site by making it clear that contact with reclaimed effluent is not advisable.

44. No surface irrigation is permitted unless approved by Council and the STS is maintained and operated in accordance with the conditions of accreditation issued for the system by the NSW Ministry of Health and the conditions of this approval.
45. If surface irrigation is approved, a sprinkler system with a plume of coarse droplets at a height of not more than 0.4m is to be installed, with the supply lined buried 0.1m below ground.

Reason: To minimise spray drift onto other properties and parts of the allotment, and to protect the supply line from freezing.

A3.1.6. Waterless Composting Toilet System Conditions

46. Maintenance of the WCTS is to be completed in accordance with the manufacturer's operation manual. The owner/ operator of the system must obtain an operation and maintenance manual from the manufacturer.

Reason: To ensure the owner/ operator has the necessary information to carry out basic maintenance.

47. Composted waste material from the WCTS is to be disposed of by burial within the confines of the premises in soil, which is not intended to be used for at least three (3) months for the cultivation of food for human consumption. The minimum cover of soil over the deposited compost must be 100mm.

48. A permanent notice with basic instructions must be fixed to the facility in a prominent position. The permanent notice must include provisions for recording the date of commissioning and the last time compost waste was removed.

49. The fan fitted to the air vent must be installed in such a manner that it operates continuously, with easy access being supplied for repairs or replacement of the fan.

Reason: To keep the drainage bed and compost pile aerated.

50. Liquid from the WCTS is to be directed to a suitably sized subsoil absorption trench or bed.

51. No kitchen sullage or greywater is to be disposed of through the WCTS.

A3.1.7. Wet Composting System (Worm Farm) Conditions

52. Maintenance of the WCS is to be completed in accordance with the manufacturer's operation manual. The owner/ operator of the system must obtain an operation and maintenance manual from the manufacturer.

Reason: To ensure the owner/ operator has the necessary information to carry out basic maintenance.

53. Composted waste material from the WCS is to be disposed of by burial within the confines of the premises in soil, which is not intended to be used for at least three (3) months for the cultivation of food for human consumption. The minimum cover of soil over the deposited compost must be 100mm.

54. A permanent notice with basic instructions must be fixed to the facility in a prominent position. The permanent notice must include provisions for recording the date of commissioning and the last time compost waste was removed.

55. The fan fitted to the exhaust duct or the wind ventilator above the vent stack must be installed in such a manner that it operates continuously, with easy access being supplied for repairs or replacement of the fan or wind ventilator.

Reason: To keep the drainage bed and compost pile aerated.

56. Where a pump is installed in the system, a suitable audible and visual high-water alarm shall be installed and maintained in an operational condition to provide warning of a pump failure.

57. Liquid from the WCS is to be directed to a suitably sized and designed subsurface EAA.

A3.1.8. Sand Filter and Constructed Wetland Conditions

58. The standard effluent level in a constructed wetland must always remain below the gravel surface.

Reason: To prevent contact with effluent and to prevent insect breeding and odours.

59. Sand filters must be free-draining to ensure they do not become waterlogged.

Reason: To maintain aerobic conditions for effective treatment.

60. If reeds and vegetation are part of the design, these must be maintained. They must be periodically cut back and replaced if plants die.

61. The sides of the sand filter or constructed wetland must be 0.1m above the surrounding ground surface to stop inflow of overland water flows.

62. The sand filter and constructed wetland shall be maintained in a water-tight condition, including any inlet and outlet pipes. Damage to the beds shall be repaired in a timely manner to prevent pollution.

A3.1.9. Wisconsin Sand Mound Conditions

63. Dosing of the Wisconsin Sand Mound ("mound") should be small doses frequently, generally no more than 100L per dose.

64. Grass cover shall be established and maintained over the mound.

Reason: To protect the mound surface from erosion, provide evapotranspiration and prevent mulching and nutrient retention.

A3.1.10. Greywater Treatment or Diversion Device Conditions

65. Maintenance of any associated greywater diversion or treatment system to meet the performance standards of section 75A(2) of the Local Government (General) Regulation 2021 and the Plumbing Code of Australia.

66. The filter installed in the greywater diversion device shall be regularly checked and cleaned out as required to maintain adequate filtration and flow through the greywater diversion device.

67. The greywater sub-surface irrigation area must be maintained by the owner or operator. This includes pipework, fittings and irrigation lines and vegetation.

A3.1.11. Greywater Processing Device Conditions

68. The GPD must be serviced at two (2) yearly intervals by a service agent authorised by the manufacturer or supplier.

69. The GPD must only receive greywater from a shower, bath or washing machine rinse water. Greywater from the kitchen, dishwasher, spa bath and laundry tub are excluded. No wastewater from a toilet or other ablution fixture is permitted. No solids are to be discharged to the GPD.

70. The owner and occupier of the premises is to be educated and has received an owner's manual about limiting contamination of the greywater. This includes solid materials, chemicals, pharmaceuticals, paint residues, hair dye, bleach and disinfectants being strictly excluded.

71. The processed greywater from the GPD may be reused for toilet flushing, washing machine and garden purposes, provided either sub-surface irrigation is practiced, or a fixed, low pressure coarse spray is used. The treated greywater is not to be used for car washing or topping up swimming pools.

72. The GPD is to be connected to the approved OWMS to allow greywater flows to be redirected to the OWMS when required.

A3.1.12. Advisory Notes:

In addition to the above conditions:

- It is recommended that water conservation measures, including water efficient fittings throughout the dwelling, are installed to maximise the efficiency of the OWMS.
- It is recommended that water leaks in the dwelling are identified and repaired to reduce the risk of damage to the OWMS.
- It is recommended that use of anti-bacterial products and bleaches are minimised in wastewater generated in the dwelling to limit the damage to the OWMS, which is a biological treatment system.
- It is recommended that laundry detergents with low levels of sodium and phosphorus be used due to the risk of sodium damaging soil structure and phosphorus' potential impact on waterways.
- At no time should products other than biodegradable toilet paper be placed in the system. Hygiene products and 'flushable' wipes will cause blockages in any plumbing system.
- Operation of the waterless composting toilet system may require the addition of a supplementary carbon source to the compost pile. Recommendations in the owner's manual should be followed regarding suitable products.

Appendix 4:

Onsite Wastewater Management Installation

Appendix 4. Onsite Wastewater Management Installation

A4.1. Installer Qualifications

Once an OWMS design receives approval by the local council, a licensed plumber or installer may install the treatment system and effluent application system in accordance with the approved design. All plumbing leading up to the treatment system must be installed by a licensed plumber or drainer and inspected by a suitably qualified council plumbing inspector.

A4.2. Drainage Pipework

All pipework and treatment system locations must comply with AS/NZS 3500:2:2018 and must ensure wastewater can travel from the development to the treatment system and from the treatment system to the effluent application system with even distribution throughout the entire EAA. Pipe size can be decided based on the minimum grade required for adequate drainage. Table A4-1 can be used to select pipe size based on minimum grade ratio.

Table A4-1 Minimum Pipe Diameter Calculations

Nominal Pipe Size (DN)	Minimum Grade (%) ^{1, 2}	Minimum Grade Ratio
65	2.50	1:40
80	1.65	1:60
100	1.65 ²	1:60
125	1.25	1:80
150	1.00	1:100

NOTES

- Adapted from AS/NZS 3500:2:2018 Table 3.4.1. Note pipe grades are expressed as percentage of vertical to horizontal distances.
- Except for drains from septic tanks, sewage treatment plants and unvented discharge pipes from tundishes, which may have a minimum grade of 1%.

All pipework and treatment system locations must comply with minimum cover depths stipulated in AS/NZS 3500:2:2018. Table A4-2 outlines the minimum pipe depth for trafficable areas, such as under driveways. The effluent distribution pipe from the tank to the EAA must be buried at the applicable depth and in a manner that provides protection against mechanical damage or deformation.

Table A4-2 Minimum Pipe Depths¹

Pipework Location	Minimum depth of cover (mm) ²
Area subject to vehicular traffic	500
Area not subject to vehicular traffic	300

NOTES

- Adapted from AS/NZS 3500:2:2018 Table 3.7.2.
- For all materials other than cast iron and ductile iron which only requires a minimum cover depth of 300mm under areas subject to vehicular traffic.

Where a sewer pipe carrying untreated wastewater to a treatment system is longer than 60m, the minimum grade should be doubled and inspection ports should be installed at least every 30m or at any change of direction or grade.

The international colour-code for plumbing installations for recycled water is lilac (commonly referred to as 'purple' or 'purple-pipe'). The pipework conveying recycled water from a treatment unit to an effluent application system or indoor recycling fixtures must be lilac. Where system upgrades occur

and incorporate recycled water, any above ground taps, pumps, signs or hatches should be retrofitted with purple paint or tape.

A4.3. Tank Installations

All system installations must comply with the manufacturer's recommendations and AS/NZS 3500.2:2018. Best practice installation considers:

- Adequate access must be provided for maintenance, desludging and ventilation.
- All proprietary tanks/ system units should be manufactured and transported to the installation site as one complete unit to preserve their structural integrity.
- Tanks should be kept upright and not laid on their side.
- When moving and lifting a tank, only use the designated lifting points shown on the outside of the tank and not the rim of the tank or the lid/ inspection holes.
- Forklifts should only be used to move systems where the lift arms reach completely under the base to fully support the system.
- When excavating and preparing a hole for a system, the depth of the hole depends on the fall of the pipe to the tank and the distance from the installed tank to the wastewater source and manufacturer specifications.
- The excavated hole should be cleared of roots, large rock material and foreign matter.
- The base of the hole is to have a flat and level bed of $\geq 50\text{mm}$ of compacted sand.
- The tank inlet should be in line with the inlet pipes.
- The tank should be carefully lowered into the prepared hole and not dropped.
- The tank should be installed so that the lid is at least 100mm above final ground level to avoid stormwater ingress, unless the tank is specifically designed to be installed below the ground level with suitable sealed risers.
- Tank inlet connections to inlet pipe should be made with a 100mm rubber sleeve to secure pipework into inlets and outlets as per AS/NZS 3500.2:2018 and manufacturer's recommendations.
- The tank lids are to be sealed and inlet/ outlet connections sealed with an appropriate durable and flexible sealant to prevent stormwater ingress.
- Do not start backfilling until connections and any required anchors are all complete.
- Regulatory authority inspection should be completed before back filling.
- All systems should be located above the necessary flood level as prescribed by the local council or suitably sealed in accordance with the approved design.

A4.3.1. Tank Installations with insufficient stormwater or groundwater drainage

For sites where stormwater or groundwater cannot adequately drain away from the excavated hole, or where flooding occurs, additional works are required to avoid hydrostatic uplift (i.e. where the tank is lifted out of the ground by water pressure). In these cases, infiltrated stormwater and/ or groundwater should be drained from around the tank using agricultural pipe and a free draining backfill, given there is enough fall for the water to exit the pipes. Where there is insufficient fall to achieve this, the system should be anchored. On sloping sites and sites with high surface water flows,

stormwater diversion devices are needed to prevent ponding and pooling around the top of the installed system.

Size and installation of ground anchors must comply with AS/NZS 1546.1:2008. Each side of the tank must be anchored using a piece of filled pipe attached to the tank by durable ties made from stainless steel cable. The ties are fitted to the anchor points on the tank and have a loop at the other end at excavation base level. Backfilling covers the anchors securing the tank in the ground. To prepare ground anchors on a poly tank it is recommended to:

- Fill the ground anchors (100mm uPVC sewer pipe) with sand and cap the ends. Attach at least two anchors to a tank, parallel to each other, on opposite sides of the tank. Use more anchors if the soil is prone to saturation. The anchors should be at least as long as the diameter of the tank.
- Secure the free end loops of cable around the ends of each ground anchor, with two cables to each anchor.
- Fit a stainless steel shackle in each cable through pre-drilled holes in vertical ribs of each tank and secure.
- Hang all ground anchors level beside the tank approximately 150mm from the bottom of the excavation, with cables fully secured and all fastenings securely tightened. Sand filled anchors help tighten the cables and ensure maximum effect. Never run cables through the anchor pipes as they will cut when under load.

Alternatively, a hydrostatic flange and anchor collar may be fitted. An 'L' shaped anchor collar section at least 65mm wide and 6mm thick should be constructed and fixed to the outside circumference of the tank with durable material protected from corrosion. The collar can be continuous around the circumference or in at least two sections each at least 0.6m long and fixed on opposite sides of the tank. For a vertical cylindrical tank, the flange is fixed less than 300mm from the base. For a horizontal cylindrical tank, the flange is situated along the line of the greatest horizontal perimeter.

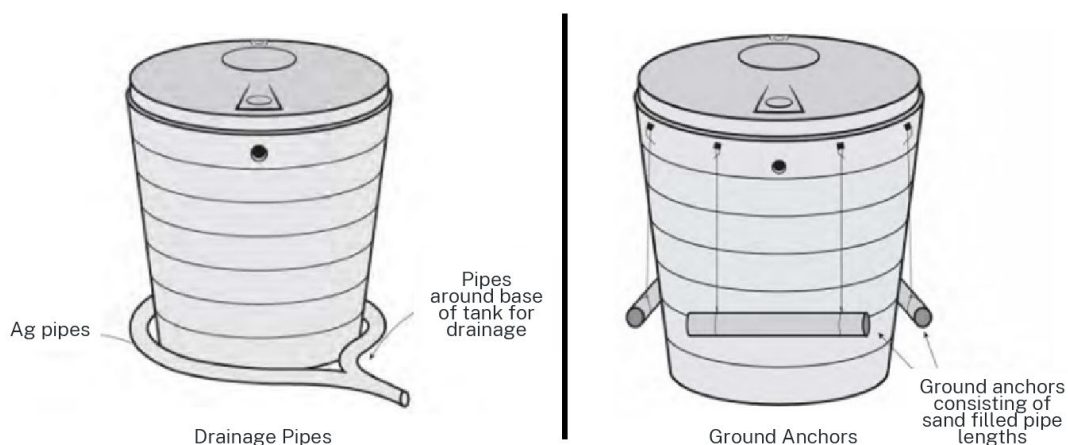

Figure A4-1: Drainage pipes and ground anchors

Adapted from Designing and Installing On-site Wastewater Management System' from WaterNSW (2023a)

A4.3.2. Tank Installations with wet ground

To avoid smearing of surrounding soil when installing systems in wet ground, installers should:

- Ensure all suitable approvals are sought for any site with potential for acid sulfate soils.

- Excavate the hole while using spear points or vortex pumps to lower the groundwater table.
- Use concrete to provide a ballast where appropriate.
- Ensure 100mm thick concrete base with S72 mesh reinforcing is poured in the excavation hole and is made level.
- Use the tank's eight anchor points and four sand filled pipe ground anchors and place on wet concrete and ensure base is level.
- Fill tank with water and pour remaining concrete around tank evenly, not exceeding the depth of the water ballast in the tank. This fully encapsulates the base preventing any pressure being applied to the base.

A4.3.3. Pumps and Pump Wells

Different system designs can use different types of pumps. The most common are a pump directing clarified effluent from a treatment system to an EAA. These are commonly submersible pumps and must be designed for use with effluent. The pump inlet must draw from a separate chamber or tank to the treatment processes, where the effluent has minimal solids. Where a sewage ejection pump station is used with a pump-to-sewer or treatment system, there will be a grinder or macerator pump in the chamber of the tank. These pumps are designed to pump both liquid and solids to the treatment location.

Do not use a macerator or grinder pump to transfer liquid directly from a septic tank to an EAA, as the latter will block and fail due to the high solid content in the liquid.

Where pumped transfers are carrying pre-treated wastewater to an effluent application system the minimum dose should be 2-3 times the delivery pipe's fill volume. Pump specifications should meet the design system specifications for even application of effluent.

A4.4. Effluent Application System Installations

All effluent application systems are to be installed in accordance with AS/NZS 1547:2012 and AS/NZS 3500.2:2018, generally:

- All EAA systems should be constructed parallel to the contour.
- Laser levelling should be used to ensure the base of the EAA is exactly level.
- EAAs must be vegetated as soon as possible following installation.
- Install EAAs during fine weather conditions, and cover them in the event rain conditions start before construction has finished.
- A stormwater diversion drain or berm should be built upslope of the EAA.
- Only use friable, loamy topsoil on EAAs, not poor topsoil or subsoil.
- Where significant earthworks are required, remove topsoil from the EAA and stockpile. If it is friable loamy topsoil, it can be used on the EAA, otherwise import topsoil.

A4.4.1. Absorption and ETA Trench or Bed Systems

- Avoid cutting trenches and beds through existing weakened ground (e.g. through the alignments of former underground pipes, cables or conduits) as disturbed soils may contain preferential pathways for the movement of effluent.
- The base of the trench or bed should be level. If required, the high side can be further hand-dug to level the base, which should be confirmed by laser levelling.

- Where trenches and beds are dug by excavator in clayey soils, any smearing of the trench walls and floor should be roughened by scarifying the smeared surfaces.
- Trenches and beds should not be constructed in dispersive soils without the addition of soil ameliorant as required.
- Ensure any self-supporting pipes or arch (ReIn) used complies with the minimum dimensions in AS/NZS 1547:2012.
- Ensure side walls of trenches and beds are not damaged when filled with media.
- Ensure the geotextile extends at least 50mm above the top of the trench or bed side walls and overlap the edges of the geotextile if multiple pieces are used.
- Install inspection ports at the end of each trench or bed to allow inspection of effluent depth.
- Ensure topsoil is slightly mounded above ground level to allow it to settle and to promote rainfall shedding.
- Vegetate the top of the trench or bed system with turf or grass promptly following construction.
- Ensure larger deep-rooting plants are not planted in close proximity to trench or bed systems to reduce the risk of root intrusion and clogging.

A4.4.2. Wick System

In addition to the above for absorption and ETA systems:

- Excavate the trench to a depth of 0.6m and the adjacent pan to 0.13m or 0.18m for primary and secondary effluent systems respectively.
- Lay 'A12 grade' geotextile with dry pore size 130µm (or similar product) in a continuous length across the trench and the pan i.e. down the outer side wall of the trench, up the inner side wall of the trench and up the outer side wall of the pan. The geotextile liner should not be underneath the trench.
- Lay 'A12 grade' geotextile with dry pore size 130µm (or similar product) in a continuous length to "wrap" the media in the trench and bed. The geotextile should not be placed beneath the trench to avoid the possibility of clogging, but should extend down either side of the trench, under the gravel in the pan and across the top of both the pan and the trench.
- Ensure the geotextile extends at least 50mm above the top of the trench side walls and overlap the edges of the geotextile down the length of the trench and pan system.
- Place the 410mm wide plastic self-supporting arch into the trench.
- Install inspection ports at trench entry points and the connection points to other trenches.
- Install a mica-flap or plastic air admittance vent at the end of each trench to facilitate air being drawn into the trench, including for pressure dosed systems.
- Spread clean 20-30mm gravel over the arch in the trench and across the pan to a depth of 30mm. Ensure the top of the gravel layer is level.
- Lay geotextile across the top of the gravel layer as above.

- Spread good quality friable and permeable loamy soil over the top of the geotextile to a depth of 100mm for secondary effluent and 150mm for primary effluent systems. Local authority soil depth requirements should be considered where primary treated effluent is applied.
- Plant the topsoil with a suitable grass or plants that thrive when their roots are continuously wet, especially those with large leaves as they will transpire more water than plants with small leaves.
- To prevent flooding of the septic tank, the surface level of the Wick Trench must be at least 150mm below the invert of the septic tank outlet, otherwise a suitably sized distribution pump must be used.

A4.4.3. Subsurface Irrigation System

- Use only subsurface drip line designed specifically for effluent irrigation. Pressure-compensating subsurface drip line (typically 16mm) is used with emitters and laterals at approximately 0.6m spacings (a maximum of 0.1m spacings) and buried 100-150mm deep.
- Automatic hydraulically operated sequencing valves are recommended to supply effluent evenly to smaller zones.
- Adequate filtration must be incorporated in the system. Install a disc filter of 80 mesh (200 micron) before the sequencing valve.
- If the design incorporates supply and flush manifolds, to ensure flushing of all laterals it is essential that the supply manifold is fed from the opposite end to the end the flushing manifold is drained from. This applies equally to both manual and auto flushing systems.
- Either use drip line impregnated with root inhibitor, or use a tech filter that dispenses a root inhibitor to protect drip line from root ingress.
- It is best practice for the system to use timed dosing, particularly where load generation varies over time. This will require an adequately sized pump well and irrigation controller to be incorporated.
- Air release valves need to be installed at high points in each area or field, and additional air release valves may be needed in undulating terrain.
- A flush valve must be installed on the return line to facilitate flushing back to the treatment system, or a field flush to an in-field soakage pit. Ensure that chlorinated effluent is not returned to the primary chamber of the treatment system where the chlorine may adversely affect the biological treatment processes. The flushing return manifold should be 25mm uPVC or polyethylene line buried at 300mm.
- Fit a non-return valve where the effluent irrigation area is located above the treatment system or pump well.
- Adequately vegetate the effluent irrigation areas with species suited to effluent irrigation before the irrigation system is commissioned.
- Protect the SSI area from vehicle and stock access.

A4.4.4. Surface Irrigation System Installations

- Build the laterals of the irrigation system along the contours to avoid uneven distribution.

- Automatic hydraulically operated sequencing valves are recommended to supply effluent evenly to smaller zones.
- An 80 mesh (200 micron) disc filter should be installed prior to the sequencing valve and cleaned at least every three months.
- Where irrigation areas are above the pump well, non-return valves should be installed.
- Erect adequate signs to indicate that the area is being irrigated with effluent.
- Erect fencing or plant shrubs around the edge of the effluent irrigation area to protect it and prevent access by vehicles, livestock, domestic animals or children.

A4.4.5. Erosion and sediment controls

All installations where the ground is disturbed by excavation will require erosion and sediment controls. These controls must be installed in accordance with *Managing Urban Stormwater: Soils and Construction Vol 1 4th ed.* (Landcom 2004) (the 'Blue Book').

Appendix 5:

Onsite Wastewater Management System Operation and Maintenance

Appendix 5. Onsite Wastewater Management System Operation & Maintenance

A5.1. Treatment System Operation

Treatment systems require periodic inspections and maintenance either through an on-going service contract or a less formal arrangement to ensure adequate system operation and functioning. The following Table A5-1 outlines the recommended minimum assessment of onsite wastewater treatment systems during inspections and the appropriate personnel to carry out the inspection.

Table A5-1: Operational requirements of onsite wastewater treatment systems

System	Minimum operational requirements	Appropriate inspection personnel
Septic tank	Annual inspection of: <ul style="list-style-type: none"> → Scum and sludge levels → Blockages in inlet/ outlet → General condition of tank → Condition of outlet filter Periodic cleaning of outlet filter and desludging of septic tank as required	System owner, service contractor or agent, wastewater consultant
WCS	Annual inspection of: <ul style="list-style-type: none"> → Ventilation systems → Composted waste accumulation → Worm activity and casings Periodic compost removal as required	System owner, service contractor or agent, wastewater consultant
WCT	Annual inspection of: <ul style="list-style-type: none"> → Ventilation systems → Composted waste accumulation → Heating elements (if present) → Bulking agent supply (e.g. saw dust) → Moisture content of compost → Blockages within the waste grate or screen Periodic compost removal Regular addition of bulking material	System owner, service contractor or agent, wastewater consultant
AWTS	Quarterly service and inspection to manufacturer's specification including: <ul style="list-style-type: none"> → Sludge depth in all chambers including primary, aeration and clarification chambers → Biofilm growth on the filter media → Pumps, motors and blower assemblies → Sludge return lines and skimmers → Any electrical control system including alarm systems and irrigation control → Disinfection unit (where installed) → Replenishment of the disinfectant (where applicable) → Effluent quality testing is to be carried out as part of the inspection for: <ul style="list-style-type: none"> ○ Dissolved oxygen from a sample taken from the aeration chamber 	Service contractor or system manufacturer's agent

System	Minimum operational requirements	Appropriate inspection personnel
	<ul style="list-style-type: none"> ○ pH level in the primary chamber and final effluent ○ Free residual chlorine level in the final effluent using the DPD (N,N-diethyl-p-phenylenediamine) colorimetric or photometric method → Condition and cleaning of filter → Condition and operation of irrigation controls, pump and cycling of dual pump systems Periodic desludging of chambers as required	
ASMFS	Annual inspection of: <ul style="list-style-type: none"> → Dosing mechanisms → Biofilm build-up on filter media and cleaning where required 	System owner, service contractor or agent, wastewater consultant
Constructed wetlands	Annual inspection of: <ul style="list-style-type: none"> → Plant density and health → Water level → Structural condition of container → Plant harvesting and weeding 	System owner, service contractor or agent, wastewater consultant
GTS	3-12 month inspection as per the NSW Health accreditation certificate for the system: <ul style="list-style-type: none"> → As per manufacturer's recommendations 	Service contractor or system manufacturer's agent
Grease arrestor/ grease trap	Quarterly inspection of: <ul style="list-style-type: none"> → Solids and liquids levels → General condition of unit including baffles and lid Periodic cleaning of grease arrestor/ trap as required	System owner, service contractor or agent, wastewater consultant

A5.2. Desludging Requirements

Annual inspections of primary treatment systems or other chambers within other treatment systems should measure the level of scum and sludge to indicate when desludging is required. Sludge depths can be measured with an appropriate device (e.g. "Sludge Judge"/ "Sludge Depth Indicator"). The level of scum and sludge in a tank or chamber cannot be reliably measured by visual inspection only. Some tanks don't display a scum layer, but may have a substantial sludge layer.

The frequency of desludging depends upon solids production and tank size, approximately every three to five years is common for full occupancy where the tank has been sized appropriately. The exception is when the total sludge and scum level is equal to one-third of the depth of the tank, or when sludge or scum are within 150mm of the base of the inlet or outlet, where desludging is required sooner.

Sludge can only be removed by a licensed liquid waste contractor. When sludge is removed from a primary tank/ chamber approximately 10% of the sludge material should be retained to promote the regeneration of bacterial populations and the tank should be immediately filled with water to the outlet level to avoid potential hydrostatic uplift of the tank.

A5.3. Compost Removal Requirements

WCT systems and WCSs use composting processes as part of the treatment train. Composted material generated needs to be periodically disposed of appropriately. Unless otherwise directed by local council, compost is to be disposed of by the system owner or licenced contractor via burial within the confines of the premises in soil $\geq 100\text{mm}$ below the surface, which is not intended for the cultivation of food for human consumption.

A5.4. STS, AWTS and GTS Service Contracts

Accreditation conditions require that the owner/ occupier of a premises where a secondary treatment system, an AWTS or GTS is installed and operated shall enter into a minimum 12 month service contract or agreement with the manufacturer's employed service agent or a service agent authorised by the manufacturer. This should be a condition of consent for the operation of the system. See NSW Health 'Advisory Note 5: Servicing of Single Domestic Secondary Treatment Sewage Management Facilities (SMF)' (2018) for additional information.

A5.4.1. Local Council's Role

The local council's role in the operation and maintenance of OWMSs is regulatory, being the oversight of servicing for those systems that are required to be serviced according to their accreditation conditions, and otherwise, oversight and enforcement of the conditions of consent applied to each system on the approval to operate issued to the owner. Oversight includes operational inspections that are completed as part of the approval to operate process.

Servicing conditions of accreditation are applied to onsite single domestic secondary treatment systems which treat sewage or greywater when these systems are accredited under Australian Standards *AS1546.3:2017* and *AS1546.4:2016* respectively. Clause 45 of the LG Regulation requires that conditions of accreditation must be complied with as a condition of "approval to operate a system of sewage management".

In order to monitor the servicing of STS, AWTS and GTS, local councils should require as a condition of consent that a copy of each service report is supplied to the council. This will provide data on servicing, operational condition and required works and their completion. The local council should maintain a register of all service agents operating in its area.

A5.5. Effluent Application System Operation and Maintenance

EAA systems require periodic inspections and maintenance. Where a service contract is in place, this should be carried out by service agents as part of the regular contracted service. Otherwise, the required service may be carried out by the system owner or a service contractor on their behalf to assess ongoing operational condition. These inspections should include those listed in Table A5-2 below.

Table A5-2: Operational requirements of effluent application systems

System	Minimum operational requirements	Appropriate inspection personnel
Passive dosing system	Quarterly inspection of: <ul style="list-style-type: none">→ Operation of passive dosing system→ General condition of tank→ Sludge or scum build up in tank	System owner, service contractor or agent

System	Minimum operational requirements	Appropriate inspection personnel
Distribution box	Quarterly inspection of: <ul style="list-style-type: none"> → Even distribution of effluent and adjustment of outlet levelling devices as required → General condition of box including that it is sealed with no stormwater entry or solids build-up, including soil transported by ants 	System owner, service contractor or agent
Sequencing valve	Quarterly inspection to manufacturer's recommendations, including: <ul style="list-style-type: none"> → Sequencing successfully → General condition of valve 	Service contractor or agent
All effluent application areas	At least annual inspection of: <ul style="list-style-type: none"> → General condition including moisture at surface (leaks/pooling effluent) → Even application of effluent evident (even growth of vegetation and even moisture) → Effluent level in inspection openings → Vegetation cover and maintenance → Condition of stormwater diversion system 	System owner, service contractor or agent
LPED/ pressure dosed trenches/ beds	At least annual inspection of: <ul style="list-style-type: none"> → Flush pressure lines 	System owner, service contractor or agent
Subsurface irrigation	At least quarterly inspection to manufacturer's specifications including: <ul style="list-style-type: none"> → Flush pressure lines → Check air release/ vacuum valves → Condition of warning signage 	Service contractor or agent
Surface irrigation	At least quarterly inspection to manufacturer's specifications including: <ul style="list-style-type: none"> → Flush delivery lines → Check sprinklers are all operating → Condition of warning signage 	Service contractor or agent

A5.6. Onsite Wastewater Management System Management

Management requirements for the system owner/ operator are outlined in the operational and maintenance guide provided by the system manufacturer.

General advice to occupants:

- Improve influent quality by limiting use of unsuitable household products that discharge to the treatment system (rags, plastics, female hygiene products, wipes, nappies, oils, paints, cosmetics, bleaches, food wastes, coffee beans, cleaning products, pesticides, and certain medications such as antibiotics).

- Practice water conservation and spread heavy water use activities (such as washing machines and dishwashers) over the whole week.
- Protect the system components from structural damage by vehicles, stock, lawn mowers and edge trimmers.
- Manage surrounding soil, vegetation and roots around the treatment tank to keep it clear and accessible.
- Ensure all inspection ports and access lids are maintained and sealed to the elements.
- Ensure a continuous power supply to the system where a pump or air blower are used.
- Check that any pump is operating correctly. If the system includes a standby pump, it should be regularly alternated with the operating pump to ensure that the work hours on both are approximately equal.
- Call a plumber or designated service agent as soon as practicable in the event an alarm activates or problem is identified.
- Ensure all operational requirements and services are met.
- Maintain all copies of service reports and details of installation.
- Don't water garden crops with recycled water where crops will be eaten raw or could fall onto the ground and be eaten.

Greywater recycling systems may need additional management such as:

- Maintenance of all purple-coded fixtures and signage to indicate the use of recycled water on the premise.
- Don't use recycled water for any other purposes than what has been approved (i.e. don't irrigate food crops, top up pools or wash paths, driveways).
- Don't irrigate recycled water using hand-held hoses during periods of rain or when the soil is already saturated.
- When approved, washing vehicles with recycled water should be done over vegetated areas where recycled water can infiltrate the soil rather than be directed to stormwater drains or elsewhere.

A5.7. OWMS Emergency Management

Management of an OWMS during emergency events, such as flood, bushfires and electrical outage, is necessary for continued use of the OWMS. NSW Health has provided Advisory Notes to assist owners and operators with the impact of floods and bushfires and the recovery following these events. Table 7-1 in Section 7 provides recommendations for system design to minimise the impact of flooding and bushfires on a new or upgraded OWMS.

Table A5-3: Emergency Management of OWMS

Emergency Situation	Description	OWM Mitigation
Heavy rainfall	<ul style="list-style-type: none"> ● Saturates soil and enters treatment system components ● Increased run-on and runoff in EAA 	<ul style="list-style-type: none"> ● Seal components against water entry ● Reduce ground surface around treatment system and surcharge gully ● Maintain good stormwater diversions and cut-off drains for subsoil moisture above treatment system and EAA ● Fill in any dips or hollows in EAA to encourage stormwater runoff
Flooding	<ul style="list-style-type: none"> ● Flood water ingress in treatment system including sediment ● Damage to electrical components ● Solids carryover to EAA ● Flood waters saturate EAA 	<ul style="list-style-type: none"> ● Prepare for flood event by turning off electrical components and seal off low-lying openings where practical ● During flood event, avoid contact with contaminated flood water and minimise water usage within house ● Avoid use of flooded OWMS components ● Pump out flooded components using a licensed liquid waste contractor ● Contact service technician and/or licenced plumber for system recommissioning before using again after a flood ● Check for pipe blockages within house and OWMS delivery lines ● Check for potential hydrostatic uplift of tanks ● Dry out electrical control and/or fuse boxes and contact a licenced electrician before turning on again. May require replacement of submerged electrical components ● EAA may need to be replaced or refurbished in the event of solids carryover ● Spray irrigation nozzles or subsurface drippers should be checked and replaced

Emergency Situation	Description	OWM Mitigation
Bushfire	<ul style="list-style-type: none"> ● Damage to structural integrity of tanks (particularly plastic and fibreglass) ● Damage to PVC pipes and plastic irrigation pipework (surface and shallow subsurface) ● Pumps and electrical component damage 	<ul style="list-style-type: none"> ● Prepare for bushfire event by turning off electrical components ● During bushfire event, minimise water usage within house ● Avoid use of damaged OWMS components ● Contact service technician and/or licenced plumber for system recommissioning before using again after a bushfire ● Check for tank damage ● Check for pipe blockages within house and OWMS delivery lines ● Contact a licensed electrician before turning electrical components on again ● Spray irrigation nozzles or subsurface drippers should be checked and replaced
Electrical outages	<ul style="list-style-type: none"> ● Reduced treatment system performance 	<ul style="list-style-type: none"> ● Contact a licensed electrician before turning electrical components on again ● Contact service technician and/or licenced plumber for system recommissioning

Appendix 6:

Onsite Wastewater Management Design Worked Examples and Case Studies

Appendix 6. Onsite Wastewater Management Design Worked Examples & Case Studies

A6.1. ASMFS Site-Specific Design

A6-1 Example Case Study

An ASMFS (intermittent sand filter) dosed with primary treated effluent is to be installed to service a 3-bedroom house with onsite (tank) water supply.

Step 1: Calculate limiting hydraulic and organic loading rates

The hydraulic loading rate is calculated from the design hydraulic load and cannot exceed 50L/m²/day.

$$\begin{aligned}\text{Hydraulic loading rate} &= 600\text{L/day} / 50\text{L/m}^2/\text{day} \\ &= 12\text{m}^2\end{aligned}$$

The organic loading rate is calculated from the BOD content in the effluent to be dosed to the sand filter and cannot exceed 25L/m²/day. In this example, BOD content is calculated using the effluent quality data in Table 5-2 of this Guideline for primary treated effluent.

$$\begin{aligned}\text{Organic loading rate} &= [(600\text{L/day} \times 150\text{mg/L}) / 1,000] / 25\text{g/m}^2/\text{day} \\ &= 3.5\text{m}^2\end{aligned}$$

Out of the hydraulic and organic loading rates calculated, the hydraulic rate is determined as the 'limiting' factor. Therefore, the sand filter ASMFS system requires a (minimum) infiltrative surface area of 12m² based on the limiting hydraulic rate.

Step 2: Calculate a suitable length: width (L: W) ratio

Suitable L: W ratios range from 2:1 and 10:1. Recommended system dimensions are 6m (length) x 2m (width) giving a L: W ratio of 3:1.

A6.2. Constructed Wetland Site-Specific Design

A6-2 Example Case Study

A constructed wetland system dosed with primary treated effluent is to be installed to service a 3-bedroom house with onsite (tank) water supply.

Step 1: Calculate required volume to meet necessary hydraulic retention time (HRT)

$$\begin{aligned}\text{Volume (V)} &= (5\text{-days HRT} \times \text{design hydraulic load}) / \text{gravel porosity} \\ &= (5\text{-days} \times 600\text{L/day}) / 0.3 \\ &= 10,000\text{L}\end{aligned}$$

Step 2: Calculate container requirements with a suitable length: width (L: W) ratio

Suitable L: W ratios range from 3:1 and 1:1. Recommended system dimensions are subject to container specifications, in this example, the preferred pre-fabricated container is a poly tub with operational dimensions 3.0m (length) x 2.4m (width) and 0.7m (where wetted depth 0.1m below lip of tub) giving effective capacity of ~5m³ each. To achieve the required volume, two reed bed tubs would need to be installed in series.

Final reed bed dimensions in series are 6m length (2 x 3m long tubs) and 2.4m width, giving a L: W ratio 2.5:1 and satisfying L: W requirements.

A6.3. Water and Nutrient Balance Modelling

A6-3 Example Case Study

EAA sizing is to be carried out based on water and nutrient balance modelling for an OWMS design for a 3-bedroom house with onsite (tank) water supply. The results of the SSE demonstrated weakly structured clay loam subsoils based on a borehole assessment to 1.2m below ground surface and maximum slope gradients of 10% on a managed lawn area.

Refer to Figures A6-1 to A6-5 for this example case study. The case studies have been calculated using climate data from BoM (Station 066037) as an example.

Example 1: Secondary irrigation system with zero storage

Water Balance Model Inputs:

Design hydraulic load = 600L/day

DIR = 3.5mm/day (From Table M1 AS/NZS 1547:2012 for weakly structured clay loam)

Rainfall/Runoff Coefficient = 0.8 (10% slope)

The minimum EAA required for an irrigation system with zero storage is 235m² (rounded) based on the water balance.

Example 2: Secondary absorption bed system with wet weather storage allowance

Water Balance Model Inputs:

Design hydraulic load = 600L/day

DLR = 10mm/day (From Table L1 AS/NZS 1547:2012 for weakly structured clay loam)

Rainfall/Runoff Coefficient = 0.8 (10% slope)

Void Space Ratio = 0.3 (piped absorption bed)

Nominated EAA = 60m² (user nominated)

The minimum EAA required for an absorption bed system with zero storage is 66m². This area can be safely reduced to 60m² with a wet weather storage allowance of 93mm. A maximum effluent depth of 93mm may be stored within the aggregate bed of the absorption system for the most climate limiting month (June) and emptied in the following months. Final bed dimensions have to conform to Table L2 AS/NZS 1547:2012.

Note that wet weather storage allowances should only be used where the SSE has demonstrated no other viable options are possible to sustain OWMS. Wet weather storage is one option for maintaining an acceptable water balance in higher rainfall areas. However increased storage of effluent on site can create additional health risk and management problems. In domestic applications all other practical water conservation and effluent management options should be considered before requiring in-bed wet weather effluent storage.

Example 3: Nutrient Balance

Nutrient Balance Model Inputs:

Design hydraulic load = 600L/day

Effluent N concentration = 30mg/L (Table 5-2 for secondary treatment)

Effluent P concentration = 10mg/L (Table 5-2 for secondary treatment)

Crop N Uptake = 240kg/ha/year (fully managed lawn groundcover)

Crop P Uptake = 30kg/ha/year (fully managed lawn groundcover)

P-sorption = 400mg/kg (clay loam subsoil)

Bulk density = 1.6g/cm³ (clay loam subsoil)

Depth of soil = 0.8m (Depth between the base of the EAA and the termination point of the SSE borehole / test pit [1.2m borehole depth – 0.4m absorption bed depth = 0.8m of soil])

The minimum area required for nitrogen and phosphorus uptake is 219m² and 270m² respectively. Therefore, the phosphorus area requirement is the limiting nutrient uptake area requirement and should be adopted for the calculation of the nutrient uptake area. Using the hydraulic area requirement determined in Example 2, the NUA is calculated as follows:

$$\begin{aligned}\text{Nutrient Uptake Area (NUA)} &= \text{Nutrient area requirement} - \text{Hydraulic area requirement} \\ &= 270\text{m}^2 - 60\text{m}^2 \\ &= 210\text{m}^2\end{aligned}$$

Example 4: Convert P-sorption mg/kg to kg/ha

To convert mg/kg value to kg/ha value, the area, depth of the receiving layer, and bulk density of the soil are required. The units of measurement need to be converted to the same units across each factor, for example g/cm³ should be converted to kg/m³ and ha to m².

Inputs

Area = 1 ha (10,000m²)

Depth of soil = 0.8m

Bulk density = 1.6g/cm³ (1,600kg/m³)

P-sorption = 400mg/kg

$$\begin{aligned}\text{P-sorption (kg/ha)} &= \text{mass of soil (area x depth x bulk density) x P-sorption (mg/kg)} \\ \text{volume} &= 10,000 \text{ m}^2 \times 0.8\text{m} (= 8,000 \text{ m}^3) \text{ mass} \\ &= 8,000 \text{ m}^3 \times 1,600 \text{ kg/m}^3 (= 12,800,000 \text{ kg}) \\ \text{P-sorped} &= 12,800,000 \text{ kg} \times 400\text{mg/kg} (5,120,000,000 \text{ mg}) \\ &= 5,120 \text{ kg/ha}\end{aligned}$$

Model Parameter	Units	Symbol	Source	Value	KEY												
					User input	Calculated value	Notes										
Design Wastewater Load	L/day	Q	Wastewater generation		1. Patterson (2006)												
Design Loading Rate (DLR) / Design Irrigation Rate (DIR)	mm/day	DLR / DIR	AS/NZS 1547:2012 and SSE														
Void Space Ratio	-	V	1 (soil/ no storage), 0.3 (gravel media) 0.45 (sand media), 0.5 (arch) ¹														
Retained Rainfall Coefficient	-	RrC	0.7 (>30% slope), 0.8 (10-30% slope), 0.9 (0-10% slope), 1.0 (flat ground)														
Nominated EAA	m ²	EAA _N	Nominated area by user														
Monthly Parameters					Jan	Feb	Mar	Apr	May	June	July	Aug	Sep	Oct	Nov	Dec	Annual
Days in month	days	D	-		31	28	31	30	31	30	31	31	30	31	30	31	365
Precipitation	mm/month	P	Median monthly data (BoM or SILO)														
Daily evaporation	mm/day	E _d	Mean daily data (BoM or SILO)														
Evaporation	mm/month	E	$E_d * D$														
Crop Factor	-	Cf	0.4-0.9 ¹ (varies with crop type and season)														
Model Inputs																	
Retained rainfall	mm/month	Rr	$P * RrC$														
Applied Effluent	mm/month	W	$(Q * D) / EAA_N$														
Inputs	mm/month	I	$(Rr + W)$														
Model Outputs																	
Evapotranspiration	mm/month	Et	$E * Cf$														
Percolation	mm/month	B	$DLR / DIR * D$														
Outputs	mm/month	O	$(Et + B)$														
Model Storage																	
Monthly storage	mm/month	S _M	$(I - O) / V$														
Cumulative storage	mm/month	S _C	$S_M + (S_M \text{ for month prior})$														
Area required for no storage	m ² /month	EAA _S	$(Q * D) / (ET - Rr + B)$														
Model Results																	
Limiting storage	mm/month	S _L	Maximum monthly S _c value														
EAA Required (no storage)	m ²	EAA	Maximum monthly EAA _S value														

Figure A6-1: Water Balance Spreadsheet Template

Model Parameter	Units	Symbol	Source	Value	KEY	
					User input	Calculated value
Design Wastewater Load	L/day	Q	Wastewater generation			
Total nitrogen in effluent	mg/L	TN	Table 5.5 of the Guideline or site-specific effluent quality data ¹			
Total phosphorus in effluent	mg/L	TP	Table 5.5 of the Guideline or site-specific effluent quality data ¹			
Design life of system	years	L	Reasonable service life of 50 years			
P-sorption soil capacity	mg/kg	P _{sorp}	Site-specific/ soil landscape-specific laboratory data or Table 4-8 of the Guideline			
P-sorption soil capacity field coefficient	%	P _{sorp} C	Capacity of a soil to sorb phosphorus in the field is 25-75% less than in measured lab conditions ²			
Soil depth for P-sorption	m	D	Soil depth from base of EAA to limiting layer and/or depth of excavation based on SSE			
Bulk density of soil	g/cm ³	B	1.8 (sandy loam), 1.7 (fine sandy loam), 1.6 (loams and clay loams), 1.4 (clays) ³			
Nitrogen plant uptake	kg/m ² /year	NPU	90 (good quality woodland), 65 (poor quality woodland), 240 (managed lawn), 120 (unmanaged lawn), 280 (improved pasture), 99 (perennial pasture), 150 (managed shrubs and some trees), 75 (unmanaged shrubs and some trees) ⁴			
Phosphorus plant uptake	kg/m ² /year	PPU	25 (good quality woodland), 20 (poor quality woodland), 30 (managed lawn), 12 (unmanaged lawn), 24 (improved pasture), 11 (perennial pasture), 16 (managed shrubs and some trees), 8 (unmanaged shrubs and some trees) ⁴			
Model Inputs						
Applied total nitrogen	kg/year	TN _A	$(Q * TN * 365) / 1,000,000$			
Applied total phosphorus	kg/year	TP _A	$(Q * TP * 365) / 1,000,000$			
Model Outputs						
Subsoil nitrogen cycle losses ⁵	kg/year	NL	$TN_A * 20\%$			
Phosphorus sorption by soil	kg/m ²	PS	$[(P_{sorp} / 1,000,000) * (B * 1,000)] * D * P_{sorp} C$			
Phosphorus plant uptake over design life	kg/m ²	PPU _L	$(PPU / 10,000) * L$			
Model Results						
Minimum area required for nitrogen uptake	m ²	NUA _N	$[(TN_A - NL) / NPU] * 10,000$			
Minimum area required for phosphorus uptake	m ²	NUA _P	$(TP_A * L) / (PS + PPU_L)$			
Minimum area for nutrient uptake	m ²	NUA	<i>Maximum value from NUA_N and NUA_P</i>			

KEY	
	User input
	Calculated value

Notes

1. Data only should be considered where NATA accredited laboratory results can be supplied to support the nutrient (effluent) quality performance of a specific treatment system.
2. Patterson (2001)
3. Hazelton & Murphy (2007)
4. WaterNSW (2019)
5. Geary and Gardener (1996)

Figure A6-2: Nutrient Balance Spreadsheet Template

Model Parameter	Units	Symbol	Source	Value	KEY												
					User input		Calculated value										
Design Wastewater Load	L/day	Q	Wastewater generation	600	3-bedroom house with on-site (tank) supply												
Design Loading Rate (DLR) / Design Irrigation Rate (DIR)	mm/day	DLR / DIR	AS/NZS 1547:2012 and SSE	3.5	Table M1 AS/NZS 1547:2012 weakly structured clay loam subsoil												
Void Space Ratio	-	V	1 (soil/ no storage), 0.3 (gravel media) 0.45 (sand media), 0.5 (arch) ¹	1	Subsurface irrigation EAA proposed												
Retained Rainfall Coefficient	-	RrC	0.7 (>30% slope), 0.8 (10-30% slope), 0.9 (0-10% slope), 1.0 (flat ground)	0.8	12% slope in proposed EAA												
Nominated EAA	m ²	EAA _N	Nominated area by user	235	Notes 1. Patterson (2006)												
Monthly Parameters					Jan	Feb	Mar	Apr	May	June	July	Aug	Sep	Oct	Nov	Dec	Annual
Days in month	days	D	-	31	28	31	30	31	30	31	31	30	31	30	31	365	
Precipitation	mm/month	P	Sydney Airport AMO (BoM 066037)	71.7	86.1	94.8	81.0	79.0	100.4	51.6	45.8	47.1	48.0	66.3	62.5	1093.4	
Daily evaporation	mm/day	E _d	Sydney Airport AMO (BoM 066037)	7.3	6.5	5.4	4.2	3.0	2.5	2.7	3.7	4.9	6.0	6.6	7.4	5.0	
Evaporation	mm/month	E	$E_d * D$	226.3	182.0	167.4	126.0	93.0	75.0	83.7	114.7	147.0	186.0	198.0	229.4	1825.0	
Crop Factor	-	Cf	0.4-0.9 ¹ (varies with crop type and season)	0.8	0.8	0.8	0.7	0.7	0.7	0.7	0.7	0.7	0.7	0.8	0.8	0.8	
Model Inputs																	
Retained rainfall	mm/month	Rr	$P * RrC$	57.36	68.88	75.84	64.8	63.2	80.32	41.28	36.64	37.68	38.4	53.04	50		
Applied Effluent	mm/month	W	$(Q * D) / EAA_N$	79.1	71.5	79.1	76.6	79.1	76.6	79.1	79.1	76.6	79.1	76.6	79.1		
Inputs	mm/month	I	$(Rr + W)$	136.5	140.4	155.0	141.4	142.3	156.9	120.4	115.8	114.3	117.5	129.6	129.1		
Model Outputs																	
Evapotranspiration	mm/month	Et	$E * Cf$	181.0	145.6	133.9	88.2	65.1	52.5	58.6	80.3	102.9	148.8	158.4	183.5		
Percolation	mm/month	B	$DLR / DIR * D$	108.5	98.0	108.5	105.0	108.5	105.0	108.5	108.5	105.0	108.5	105.0	108.5		
Outputs	mm/month	O	$(Et + B)$	289.5	243.6	242.4	193.2	173.6	157.5	167.1	188.8	207.9	257.3	263.4	292.0		
Model Storage																	
Monthly storage	mm/month	S _M	$(I - O) / V$	-153.0	-103.2	-87.4	-51.8	-31.3	-0.6	-46.7	-73.0	-93.6	-139.8	-133.8	-162.9		
Cumulative storage	mm/month	S _C	$S_M + (S_M \text{ for month prior})$	0	0	0	0	0	0	0	0	0	0	0	0		
Area required for no storage	m ² /month	EAA _S	$(Q * D) / (ET - Rr + B)$	80	96	112	140	168	233	148	122	106	85	86	77		
Model Results																	
Limiting storage depth	mm/month	S _L	Maximum monthly S _c value	0													
EAA Required (no storage)	m ²	EAA	Maximum monthly EAA _S value	233													

Figure A6-3: Example 1: Irrigation EAA with Zero Storage

Model Parameter	Units	Symbol	Source	Value	KEY												
					User input		Calculated value										
Design Wastewater Load	L/day	Q	Wastewater generation	600	3-bedroom house with on-site (tank) supply												
Design Loading Rate (DLR) / Design Irrigation Rate (DIR)	mm/day	DLR / DIR	AS/NZS 1547:2012 and SSE	10	Table L1 AS/NZS 1547:2012 weakly structured clay loam subsoil												
Void Space Ratio	-	V	1 (soil/ no storage), 0.3 (gravel media) 0.45 (sand media), 0.5 (arch) ¹	0.3	piped gravel trench EAA proposed												
Retained Rainfall Coefficient	-	RrC	0.7 (>30% slope), 0.8 (10-30% slope), 0.9 (0-10% slope), 1.0 (flat ground)	0.8	12% slope in proposed EAA												
Nominated EAA	m ²	EAA _N	Nominated area by user	60	Notes 1. Patterson (2006)												
Monthly Parameters					Jan	Feb	Mar	Apr	May	June	July	Aug	Sep	Oct	Nov	Dec	Annual
Days in month	days	D	-	31	28	31	30	31	30	31	31	30	31	30	31	365	
Precipitation	mm/month	P	Sydney Airport AMO (BoM 066037)	71.7	86.1	94.8	81.0	79.0	100.4	51.6	45.8	47.1	48.0	66.3	62.5	1093.4	
Daily evaporation	mm/day	E _d	Sydney Airport AMO (BoM 066037)	7.3	6.5	5.4	4.2	3.0	2.5	2.7	3.7	4.9	6.0	6.6	7.4	5.0	
Evaporation	mm/month	E	$E_d * D$	226.3	182.0	167.4	126.0	93.0	75.0	83.7	114.7	147.0	186.0	198.0	229.4	1825.0	
Crop Factor	-	Cf	0.4-0.9 ¹ (varies with crop type and season)	0.8	0.8	0.8	0.7	0.7	0.7	0.7	0.7	0.7	0.8	0.8	0.8		
Model Inputs																	
Retained rainfall	mm/month	Rr	$P * RrC$	57.36	68.88	75.84	64.8	63.2	80.32	41.28	36.64	37.68	38.4	53.04	50		
Applied Effluent	mm/month	W	$(Q * D) / EAA_N$	310.0	280.0	310.0	300.0	310.0	300.0	310.0	310.0	300.0	310.0	300.0	310.0		
Inputs	mm/month	I	$(Rr + W)$	367.4	348.9	385.8	364.8	373.2	380.3	351.3	346.6	337.7	348.4	353.0	360.0		
Model Outputs																	
Evapotranspiration	mm/month	Et	$E * Cf$	181.0	145.6	133.9	88.2	65.1	52.5	58.6	80.3	102.9	148.8	158.4	183.5		
Percolation	mm/month	B	$DLR / DIR * D$	310.0	280.0	310.0	300.0	310.0	300.0	310.0	310.0	300.0	310.0	300.0	310.0		
Outputs	mm/month	O	$(Et + B)$	491.0	425.6	443.9	388.2	375.1	352.5	368.6	390.3	402.9	458.8	458.4	493.5		
Model Storage																	
Monthly storage	mm/month	S _M	$(I - O) / V$	-412.3	-255.7	-193.6	-78.0	-6.3	92.7	-57.7	-145.5	-217.4	-368.0	-351.2	-445.1		
Cumulative storage	mm/month	S _C	$S_M + (S_M \text{ for month prior})$	0	0	0	0	0	93	35	0	0	0	0	0		
Area required for no storage	m ² /month	EAA _S	$(Q * D) / (ET - Rr + B)$	43	47	51	56	60	66	57	53	49	44	44	42		
Model Results																	
Limiting storage depth	mm/month	S _L	Maximum monthly S _C value	93													
EAA Required (no storage)	m ²	EAA	Maximum monthly EAA _S value	66													

Figure A6-4: Example 2: Absorption System EAA with Wet Weather Storage Allowance

Model Parameter	Units	Symbol	Source	Value	KEY	
					User input	Calculated value
Design Wastewater Load	L/day	Q	Wastewater generation	600		
Total nitrogen in effluent	mg/L	TN	Table 5.5 or site-specific effluent quality data ¹	50		
Total phosphorus in effluent	mg/L	TP	Table 5.5 or site-specific effluent quality data ¹	12		
Design life of system	years	L	Reasonable service life of 50 years	50		
P-sorption soil capacity	mg/kg	P_{sorp}	Site-specific/ soil landscape-specific laboratory data or Table 4-8 of the Guideline	400		
P-sorption soil capacity field coefficient	%	$P_{sorp}C$	Capacity of a soil to sorb phosphorus in the field is 25-75% less than in measured lab conditions ²	0.5		
Soil depth for P-sorption	m	D	Soil depth from base of EAA to limiting layer and/or depth of excavation based on SSE	0.8		
Bulk density of soil	g/cm ³	B	1.8 (sandy loam), 1.7 (fine sandy loam), 1.6 (loams and clay loams), 1.4 (clays) ³	1.6		
Nitrogen plant uptake	kg/m ² /year	NPU	90 (good quality woodland), 65 (poor quality woodland), 240 (managed lawn), 120 (unmanaged lawn), 280 (improved pasture), 99 (perennial pasture), 150 (managed shrubs and some trees), 75 (unmanaged shrubs and some trees) ⁴	240		
Phosphorus plant uptake	kg/m ² /year	PPU	25 (good quality woodland), 20 (poor quality woodland), 30 (managed lawn), 12 (unmanaged lawn), 24 (improved pasture), 11 (perennial pasture), 16 (managed shrubs and some trees), 8 (unmanaged shrubs and some trees) ⁴	30		
Model Inputs						
Applied total nitrogen	kg/year	TN_A	$(Q*TN*365)/1,000,000$	11.0		
Applied total phosphorus	kg/year	TP_A	$(Q*TP*365)/1,000,000$	2.6		
Model Outputs						
Subsoil nitrogen cycle losses ⁵	kg/year	NL	$TN_A * 20\%$	2.2		
Phosphorus sorption by soil	kg/m ²	PS	$[(P_{sorp}/1,000,000)*(B*1,000)]*D*P_{sorp}C$	0.3		
Phosphorus plant uptake over design life	kg/m ²	PPU_L	$(PPU/10,000)*L$	0.2		
Model Results						
Minimum area required for nitrogen uptake	m ²	NUA_N	$[(TN_A - NL)/NPU]*10,000$	365.0		
Minimum area required for phosphorus uptake	m ²	NUA_P	$(TP_A * L)/(PS + PPU_L)$	323.6		
Minimum area for nutrient uptake	m ²	NUA	Maximum value from NUA_N and NUA_P	365.0		

Notes

1. Data only should be considered where NATA accredited laboratory results can be supplied to support the nutrient (effluent) quality performance of a specific treatment system.
2. Patterson (2001)
3. Hazelton & Murphy (2007)
4. WaterNSW (2019)
5. Geary and Gardener (1996)

Figure A6-5: Example 3: Nutrient Balance

A6.4. Linear Loading Rate

A6-4 Example Case Study

The results of the SSE demonstrated shallow bedrock is present in the EAA as a hydraulically limiting layer at 0.8m below the ground surface, triggering the requirement to calculate the maximum Linear Loading Rate (LLR). The subsoil has been determined as a moderately structured clay loam (category 4) soil. The design hydraulic load for the site is 900L/day for a 4-bedroom house with reticulated water supply. Areal calculation indicates a basal area requirement of 90m².

The pressure dosed absorption bed is to be raised 0.2m above ground surface with a batter slope to satisfy the necessary separation requirements to the limiting layer of 0.6m.

Refer to LLR matrix in Table 6-5 of the Guidelines for this example case study.

Step 1: Determine the maximum LLR based on site conditions

Using Table 6-5, the maximum LLR for the site was determined as 37L/m/day for 8% slope, 31-60cm of natural, unsaturated soil below the application point and moderately structured clay loam subsoils.

Step 2: Calculate the LLR for the proposed design

Option 1: One absorption bed with dimensions 4m (width) by 22.5m (length).

The proposed OWMS design is illustrated as:

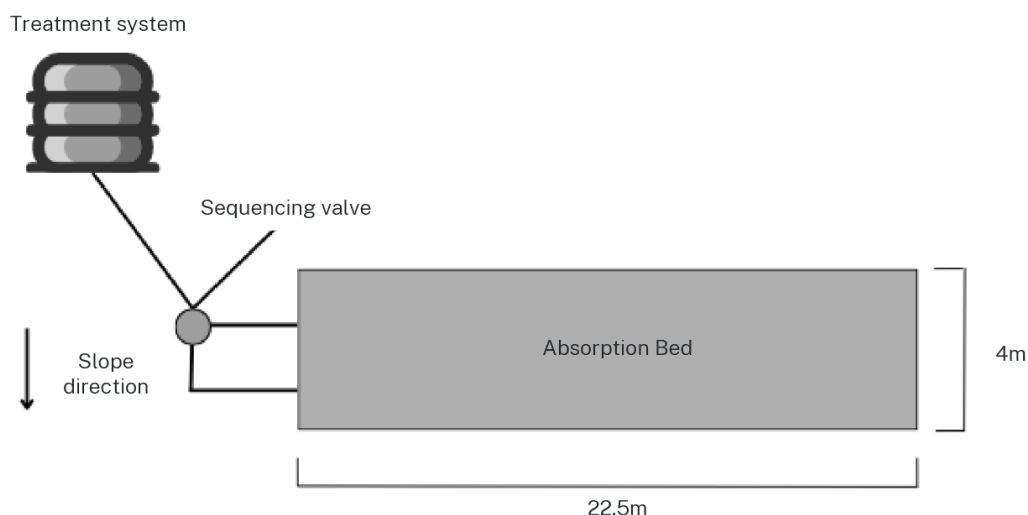

To test the LLR for the proposed design:

$$\begin{aligned}\text{LLR} &= \text{Design hydraulic load} / \text{maximum EAA length parallel to slope} \\ \text{LLR} &= 900\text{L/day} / 22.5\text{m (bed length)} \\ &= 40\text{L/m/day}\end{aligned}$$

The proposed design exceeds the maximum recommended LLR of 37L/m/day meaning the risk of effluent seepage due to the presence of a hydraulically limiting layer is determined to be high for the site conditions.

Note: the maximum bed width can be determined by dividing the LLR by the DLR.

$$\begin{aligned} \text{Maximum bed width} &= \text{LLR} / \text{DLR} \\ &= 37\text{L/m/day} / 10\text{mm/day (10L/m}^2\text{/day)} \\ &= 3.7\text{m} \end{aligned}$$

At that bed width, the total bed length required would be 24.5m (rounded up). This could be achieved as a single absorption bed which would require pressure dosing to ensure even distribution. This option might require importing a large volume of material and construction of an engineered retaining structure. This might be cost prohibitive except on the most constrained sites.

Alternative methods to meet the LLR requirement would be two absorption beds with dimensions 1.85m (width) by 24.5m (length): placed in series (end to end) (Option 2); or two absorption beds placed in parallel (stacked) (Option 3).

Option 2: two absorption beds placed in series (end to end)

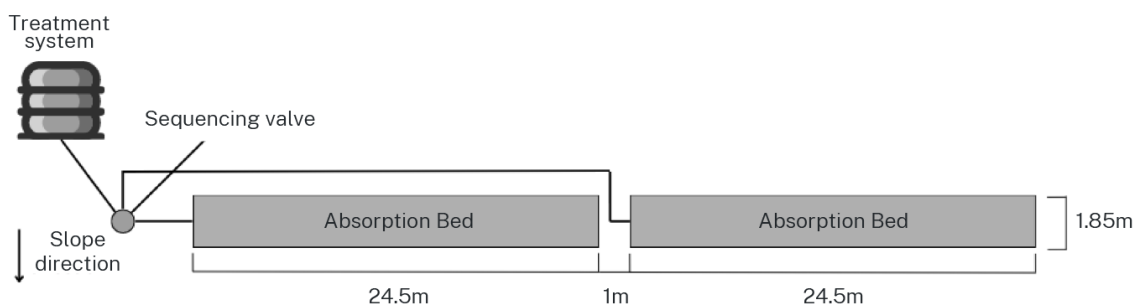

To test the LLR for the proposed design:

$$\begin{aligned} \text{LLR} &= \text{Design hydraulic load} / \text{maximum EAA length parallel to slope} \\ \text{LLR} &= 900\text{L/day} / 49\text{m (2 beds x 24.5m)} \\ &= 18.4\text{L/m/day} \end{aligned}$$

The alternative proposed design does not exceed the maximum recommended LLR of 37L/m/day and the risk of effluent seepage is acceptably low.

Option 3: two absorption beds placed in parallel (stacked)

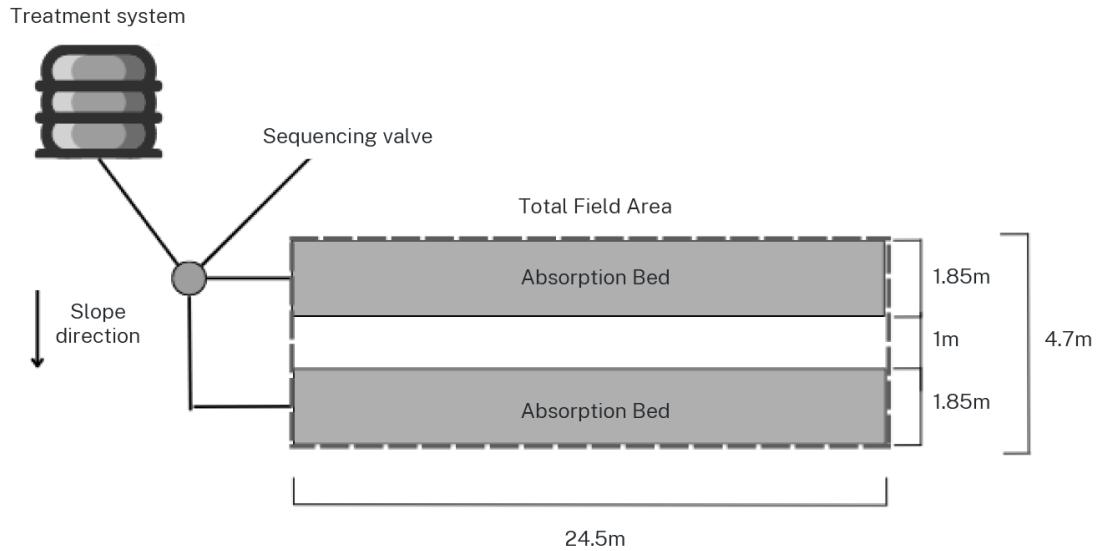

Total downslope bed width = the number of beds x individual bed width

In scenarios where two or more beds are placed in parallel, the inter bed spacing must be adjusted to achieve the required LLR.

To test the LLR for the proposed design:

$$\begin{aligned} \text{LLR} &= (\text{Design hydraulic load} / \text{Total field area}) \times \text{Total downslope bed width} \\ \text{LLR} &= (900\text{L/day} / 115.15\text{m}^2) \times 3.7\text{m} \\ &= 28.9\text{L/m/day} \end{aligned}$$

The alternative proposed design does not exceed the maximum recommended LLR of 37L/m/day and the risk of effluent seepage is acceptably low.

A6.5. Risk-Based Buffer Reduction Assessment

A6-5 Example Case Study

The results of the SSE have deemed maintaining a 40m buffer distance to intermittent waterways is not feasible for a site. A risk-based buffer reduction assessment should be carried out to support a reduction in buffer distances from a proposed EAA to an intermittent surface water feature from 40m to 30m. The proposed EAA is a subsurface irrigation area dosed by secondary treated and disinfected effluent.

The results of the SSE identified moderately structured light clay (category 5) subsoils based on borehole assessment to 1.2m below ground surface. The SSE identified that the proposed EAA is to be located on a (maximum) 10% slope gradient.

Refer to Table A6-2 and Figure A6-4 for this example case study.

Step 1: Risk Assessment

The risk assessment uses the constraint scales presented in of the Guideline. In this example, the sensitive receptor is the intermittent waterway and the risk assessment considers where each of the site and system constraints lie on the constraint scale. Where a moderate or high risk is identified, mitigation is proposed or incorporated into the design to reduce the risk.

Step 2: Viral Die-off Modelling

Viral Die-off Model Inputs:

- Groundwater temperature: 13.6°C (Daily mean minimum temperature statistics (BoM Station 066037) used in lieu of groundwater monitoring data).
- Orders of magnitude reduction: 2 (secondary treatment with disinfection).
- Days required for viral reduction: 19 days (Spreadsheet Figure A6-4).
- Bulk density: 1.4g/cm³ (light clay subsoil).
- Saturated hydraulic conductivity: 0.12m/day (From Table 5.2 AS/NZS 1547:2012 for moderately structured light clay). Where a range of permeability values are presented, the upper value is used to be conservative.
- Groundwater gradient: 0.10 (From 10% ground surface slope identified in SSE).
- Vertical drainage: 1.0m (Depth between the base of the EAA and the termination point of the SSE borehole / test pit [1.2m borehole depth – 0.2m subsurface irrigation depth = 1.0m of soil]).

The distance a virus can travel in groundwater is estimated from the equation derived from Cromer et al. (2001). In this example, it has been estimated that viruses will travel 0.4m away from the EAA, therefore, a reduction in buffer distances from 40m to 30m for intermittent surface water features is supported.

Conclusions

Based on the results of the risk assessment and further supported by the results of viral die-off modelling, a reduction in buffer distances to intermittent waterways from 40m to 30m can safely be adopted.

Table A6-2: Risk Assessment for a Buffer Reduction to Intermittent Waterways

Site Feature/ Sensitive Receptor	Buffer Distance Range (m)	Relevant site and system constraints	Constraint Scale		Applicable Constraint	Risk Assessment	Mitigation Measures Required to Reduce Risk
			Low	High			
Intermittent water bodies, farm dams, roadside drainage, drainage depressions	15.0m – 40.0m	Effluent Quality	Secondary treated effluent (with disinfection and Contractual Service Agreement)	Primary treated effluent	Secondary treated effluent (with disinfection and Contractual Service agreement)	Low	
		Surface Water	Category 1 to 3 soils no surface water down gradient within 40m; low rainfall area	Category 4 to 6 soils permanent surface water <20m down gradient; high rainfall; high resource/ environmental value	Category 5 soils; intermittent waterway ~30m downgradient; low resource/ environmental value	High	High quality effluent used (secondary with disinfection) and subsurface application OWMS design.
		Slope	0-6% (surface effluent application), 0 -10% (subsurface effluent application)	>10% (surface effluent application), >30% (subsurface effluent application)	10% subsurface effluent application	Low	
		Fall direction	Downgradient of surface water body, property boundary, recreational area	Upgradient of surface water body, property boundary, recreational area	Downgradient of surface water body, property boundary, recreational area	Low	

	Drainage	No visible signs of saturation	Visible seepage; moisture tolerant vegetation; low lying area	Low lying area	Moderate	Install up-slope diversion device to intercept run-on.
	Flood Potential	Above 1 in 20-year flood contour	Below 1 in 20-year flood contour	Above 1 in 20-year flood contour	Low	
	Method of Application	Drip irrigation or subsurface application of effluent	Surface/ above ground application of effluent	Subsurface application	Low	

Draft

Beavers, Cromer, Gardner Viral Die-off Model

Site Address		
Input Data		
		Source
Groundwater temperature (°C)	13.60	Mean minimum air temperature (BoM)
Orders of magnitude reduction	2.00	From Cromer et al. (2001) for wastewater treatment level
Days required for viral reduction	19.00	Figure 1 of Cromer et al. (2001) and reproduced below
Bulk density of soil (ρ_b) (g/m ³)	1.40	Table 2.18 of Hazelton & Murphy (2007)
Saturated hydraulic conductivity (m/day)	0.12	Table 5.2 AS/NZS 1547:2012
Groundwater gradient (fraction)	0.10	From the results of the SSE
Vertical drainage before entering groundwater (m)	1.00	From the results of the SSE
Calculate the predicted travel distance using Equation 4 from Cromer et al. (2001).		
$D_g = (t \cdot d_v \cdot P / K) / (P / K^i)$		
Time in days	t =	19.00 days
Effective porosity of soil (fraction)	P =	0.47
Saturated hydraulic conductivity	K =	0.12 m/day
Groundwater gradient (fraction)	i =	0.10
Vertical drainage before entering groundwater	d _v =	1.0 m
Setback Distance	Distance travelled in groundwater	d _g = 0.4 m

Figure 1. Relationship between Groundwater Temperature and Viral Die-Off Time for Various Order-of-Magnitude Reductions in Viral Numbers

(Figure 1 taken from Cromer et al., 2001)

Supporting Notes

A. Order of Magnitude	
Primary treatment	7
Secondary treatment (no disinfection)	3
Secondary treatment (with disinfection)	2

From Cromer et al. (2001).

B. Bulk Density of Soil	
Sand/Sandy loam	1.8
Fine sandy loam	1.7
Loam and clay loam	1.6
Clay	1.4

From Hazelton & Murphy (2007) Table 2.18.

1. Enter property address next to 'site address'
2. Enter the groundwater temperature or mean minimum air temperature as a proxy sourced from the closest BoM station to the property into input data.
3. Enter the orders of magnitude reduction based on the level of treatment and Table A into input data.
4. Use figure 1 to select the number of days required for viral reduction based on the order of magnitude reduction required and enter into input data.
5. Select the bulk density of the soil based on soil texture and Table B above and enter into input data.
6. Enter the saturated hydraulic conductivity of the soil into input data based on the upper limit value provided by Table 5.2 of AS/NZS 1547:2012 and soil category.
7. Enter the groundwater gradient of the site into input data based on the results of the SSE (i.e. surface gradient).
8. Enter the vertical drainage available between the base of the EAA and the termination of the test pit / borehole from the SSE into input data.
9. The spreadsheet can be set up to calculate the porosity of the soil based on the equation from Hazelton & Murphy (2007) where the specific gravity of soil particles (ρ_s) remains constant:

$$\text{Porosity} = 1 - \rho_b / \rho_s \quad \rho_s = 2.65$$
10. The spreadsheet can be set up to calculate the distance viruses travel in groundwater using the equation from Cromer et al. (2001):

$$\text{Distance travelled in groundwater (} d_g \text{)} = (t \cdot d_v \cdot P / K) / (P / K^i)$$

Figure A6-4: Viral Die-off Model Example

A6.6. Troubleshooting Existing Onsite Wastewater Management Systems

A6-6 Example Case Study



Secondary treatment system (AWTS) contained several cracks and was missing an inspection cover allowing rainfall and stormwater ingress into the system. The pump had failed and allowed the system to flood and electrical equipment (aerator and alarm system) all became faulty without the knowledge of system owner. The system had not been serviced in the past year. AWTS required a pump out and full service before becoming operational again including complete replacement of electrical equipment.

A6-7 Example Case Study



Surrounding condition of primary treatment system (septic tank) has not been maintained by system owner and appears buried and overgrown making access for inspection and maintenance difficult. System had not been desludged in multiple years resulting in a build-up of sludge and scum levels reducing treatment performance. It was likely the carry-over of solids would have adversely impacted on the EAA (trench) performance.

Outcome: Pump out of septic tank, reduction of soil level around the tank to below the lid level, with suitable drainage to direct stormwater away from the tank. If possible, pump out of the EAA through an inspection opening if the EAA is holding liquid at the time of inspection.

A6-8 Example Case Study



Secondary treatment system (AWTS) visibly failing due to sewage leaking from maintenance lids. Failure was suspected to be caused by blockage or malfunction of the irrigation pump by a build-up of rags (possibly 'flushable wipes'). This caused the entire system to back-up above normal operational levels, requiring a full pump out and wash-down to remove contamination from all chambers, prior to refilling with clean water to operational levels.

A6-9 Example Case Study



Secondary treatment system (AWTS) had not been serviced in over three years. Attached growth media had become detached and rose to surface of tank knocking off the aeration head array in the

process, damaging aeration components and reducing treatment performance. Regular servicing would have picked up damages earlier prompting earlier and less costly rectification works.

A6-10 Example Case Study



Absorption EAA system had been exposed to vehicular traffic causing damage to pipework and compaction of soil and poor grass cover. Vehicle activity (or grazing animals/ livestock) can cause compaction of soil and damage to vegetation resulting in premature system failure.

A6-11 Example Case Study



Absorption system installed on 18% slope, not parallel to the contours. Effluent was observed to be breaking out of the bed at the lowest point and seeping in the direction of the natural slope. Where the bed is installed with poor levelling, effluent will overtop at the lowest point. It is difficult to rectify this problem once a bed has been installed with inappropriate alignment.

Appendix 7:

Onsite Wastewater Management Checklists

Appendix 7. Onsite Wastewater Management Checklists

OWM Treatment System Installation Inspection Checklist for Installers and Council <i>(Adapted from Designing and Installing On-site Wastewater Management Systems from WaterNSW, 2023a)</i>							
Site owner:							
Address & Lot/ DP:							
Installer/ Council Reference ID:							
Installation date:							
System coordinates:							
Treatment System Description							
<input type="checkbox"/> Septic Tank		<input type="checkbox"/> WCS		<input type="checkbox"/> AWTS		<input type="checkbox"/> GTS	
<input type="checkbox"/> WCT		<input type="checkbox"/> Other (specify):					
Manufacturer:				Model #:			
Manufacturer's load bearing rate:							
<input type="checkbox"/> Plastic/ poly		<input type="checkbox"/> Concrete		<input type="checkbox"/> Fibreglass		<input type="checkbox"/> Other (specify):	
Multiple tanks:		<input type="checkbox"/> No		<input type="checkbox"/> Yes (specify):			
Specified or calculated system capacity: _____ L							
Specified or calculated tank capacities (where applicable):							
(1)	L	(2)	L	(3)	L	(4)	L
Tank dimensions and capacities (as provided on manufacturers design specification sheet):							
Exterior dimensions (diameter & height):						mm	
Interior dimensions (base to invert of outlet):						mm	
Exterior height of inlet invert:						mm	
Exterior height of outlet invert:						mm	
Effective depth:						mm	
Capacities of each compartment (where applicable):							
Anaerobic (septic):		L		Aeration:		L	

Clarifier (sludge settling):	L	Pump well (chlorine contact):	L
Other (describe):			
Tank seam location	<input type="checkbox"/> N/A	<input type="checkbox"/> Mid	<input type="checkbox"/> Top
Has the tank been appropriately sealed?			
<input type="checkbox"/> Butylmastic	<input type="checkbox"/> Butyl tape wrap	<input type="checkbox"/> Two-part epoxy	
<input type="checkbox"/> Two-part epoxy and stainless fasteners		<input type="checkbox"/> Other (specify):	
Tank structural integrity verified before setting?	<input type="checkbox"/> Yes	<input type="checkbox"/> No	<input type="checkbox"/> N/A
Excavation/ settling tanks			
Location (specify):			
Nature of installation:	<input type="checkbox"/> Free standing		<input type="checkbox"/> Buried
Verify required inlet/ outlet elevations	<input type="checkbox"/> Yes	<input type="checkbox"/> No	<input type="checkbox"/> N/A
Groundwater present in excavation	<input type="checkbox"/> Yes	<input type="checkbox"/> No	<input type="checkbox"/> N/A
Dewatering performed	<input type="checkbox"/> Yes	<input type="checkbox"/> No	<input type="checkbox"/> N/A
Bottom of excavation			
Level	<input type="checkbox"/> Yes	<input type="checkbox"/> No	<input type="checkbox"/> N/A
Free of rock and debris	<input type="checkbox"/> Yes	<input type="checkbox"/> No	<input type="checkbox"/> N/A
Bedding material			
Description:			
Depth	cm		
Free of large rocks, debris	<input type="checkbox"/> Yes	<input type="checkbox"/> No	<input type="checkbox"/> N/A
Levelled and compacted	<input type="checkbox"/> Yes	<input type="checkbox"/> No	<input type="checkbox"/> N/A
Structural integrity of tanks verified			
Tank installed level	<input type="checkbox"/> Yes	<input type="checkbox"/> No	<input type="checkbox"/> N/A
Tank oriented correctly	<input type="checkbox"/> Yes	<input type="checkbox"/> No	<input type="checkbox"/> N/A
Free standing above ground			

Flat bed	<input type="checkbox"/> Yes	<input type="checkbox"/> No	<input type="checkbox"/> N/A
Levelled and compacted	<input type="checkbox"/> Yes	<input type="checkbox"/> No	<input type="checkbox"/> N/A
Verify required inlet and outlet elevations	<input type="checkbox"/> Yes	<input type="checkbox"/> No	<input type="checkbox"/> N/A
Flotation prevention (for buried tanks only)			
Buoyancy calculations provided on design	<input type="checkbox"/> Yes	<input type="checkbox"/> No	<input type="checkbox"/> N/A
Anti-flotation implemented			
Tank collar	<input type="checkbox"/> Yes	<input type="checkbox"/> No	<input type="checkbox"/> N/A
Anchor weight	<input type="checkbox"/> Yes	<input type="checkbox"/> No	<input type="checkbox"/> N/A
Other/ Comment:			
Backfill			
Backfill material:			
Compacted	<input type="checkbox"/> Yes	<input type="checkbox"/> No	<input type="checkbox"/> N/A
Free of debris and large rocks	<input type="checkbox"/> Yes	<input type="checkbox"/> No	<input type="checkbox"/> N/A
Piping			
Piping in appropriate sequence (inlet/ outlet)	<input type="checkbox"/> Yes	<input type="checkbox"/> No	<input type="checkbox"/> N/A
Inlet	mm	Outlet/ supply line	mm
Pipe specifications (material and nominal diameter)			
Return line	mm	Electrical conduit	mm
Joints in excavated area	<input type="checkbox"/> Yes	<input type="checkbox"/> No	<input type="checkbox"/> N/A
Pipe sealing			
Pipes appropriately sealed (including electrical conduit for pump well)	<input type="checkbox"/> Yes	<input type="checkbox"/> No	<input type="checkbox"/> N/A
Type of sealant	Inlet		
	Outlet/ supply line		
	Return line (if installed)		
	Electrical conduit		

Recirculation device	<input type="checkbox"/> Yes	<input type="checkbox"/> No	<input type="checkbox"/> N/A
Type of device:			
Baffles/ compartments (where applicable)			
Inlet baffle type			
Outlet baffle type			
Effluent screen model # and manufacturer:			
Types of baffles:	<input type="checkbox"/> Poly/ Plastic	<input type="checkbox"/> Concrete	<input type="checkbox"/> Fibreglass
Installation by:	<input type="checkbox"/> Manufacturer	<input type="checkbox"/> Contractor	
Verify air passage	<input type="checkbox"/> Yes	<input type="checkbox"/> No	<input type="checkbox"/> N/A
Tank access & venting			
Access location and size	Inlet	mm	
	Outlet	mm	
	Centre	mm	
Access risers required	<input type="checkbox"/> Yes	<input type="checkbox"/> No	
Sealant used in tank/ riser connections	<input type="checkbox"/> Yes	<input type="checkbox"/> No	
Venting	<input type="checkbox"/> Yes	<input type="checkbox"/> No	<input type="checkbox"/> N/A
Through plumbing stack	<input type="checkbox"/> Yes	<input type="checkbox"/> No	<input type="checkbox"/> N/A
Tank vent (describe):			
Proprietary filter	<input type="checkbox"/> Yes	<input type="checkbox"/> No	<input type="checkbox"/> N/A
Filter manufacturer and model #:			
Tank water tightness testing	<input type="checkbox"/> Yes	<input type="checkbox"/> No	<input type="checkbox"/> N/A
Pumps operational	<input type="checkbox"/> Yes	<input type="checkbox"/> No	<input type="checkbox"/> N/A
Pump timing	<input type="checkbox"/> Yes	<input type="checkbox"/> No	<input type="checkbox"/> N/A
High water level alarm	<input type="checkbox"/> Yes	<input type="checkbox"/> No	<input type="checkbox"/> N/A

For Greywater Treatment Systems:		
The installation of the system and construction requirements are consistent with the council's conditions of consent.	<input type="checkbox"/> Yes	<input type="checkbox"/> No
Installation has been checked by manufacturer or manufacturer's agent.	<input type="checkbox"/> Yes	<input type="checkbox"/> No
The manufacturer or manufacturer's agent has certified that the installation is according to the Certificate of Accreditation.	<input type="checkbox"/> Yes	<input type="checkbox"/> No
All electrical work has been carried out by a licensed electrician according to <i>AS/NZS 3500</i> .	<input type="checkbox"/> Yes	<input type="checkbox"/> No
The tank and all associated pipe and drainage work has been inspected by a Council inspector before backfilling, to ensure correct positioning of all components and that all components have been installed according to the Plumbing Code of Australia.	<input type="checkbox"/> Yes	<input type="checkbox"/> No
An Owner's Manual has been provided and the details of operation explained to the homeowner.	<input type="checkbox"/> Yes	<input type="checkbox"/> No
For Waterless (Dry) Composting Toilet Systems:		
Type of composting system:		
<input type="checkbox"/> Continuous flow	<input type="checkbox"/> Batch processing	<input type="checkbox"/> Other (specify):
Location of composting tanks/ units (describe):		
Nature of installation:	<input type="checkbox"/> Free Standing	<input type="checkbox"/> Buried
Multiple systems	<input type="checkbox"/> Yes	<input type="checkbox"/> No
Appropriate ventilation?	<input type="checkbox"/> Yes	<input type="checkbox"/> No
Adequate provision for access?	<input type="checkbox"/> Yes	<input type="checkbox"/> No
Comments, actions or repairs required: (Where a response in the above Checklist needs extra information or action, specify the action plan and/ or the process to fix the problem, or specify an alternative that is being offered)		
Service provider and contact number:		
Inspector and contact number:		
Signature:	Date:	

OWM Site-Specific Passive Technology (Constructed Wetlands, Sand Filters and Mounds) Installation Inspection Checklist for Installers and Council

(Adapted from Designing and Installing On-site Wastewater Management Systems from WaterNSW, 2023a)

Site owner:			
Address & Lot/ DP:			
Installer/ Council Reference ID:			
Installation date:			
System coordinates:			
System description:			
System type:			
<input type="checkbox"/> Intermittent sand filter	<input type="checkbox"/> Constructed wetland	<input type="checkbox"/> Mound	<input type="checkbox"/> Other (specify):
Comment:			
System dimensions:			
Length:	m	Width:	m
Container details (where applicable and include material and manufacturer):			
Media Used?	<input type="checkbox"/> Sand	<input type="checkbox"/> Gravel	<input type="checkbox"/> N/A
Where media is incorporated into the system, does it meet the right specifications?			<input type="checkbox"/> Yes <input type="checkbox"/> No
Are the system dimensions and construction requirements consistent with council's conditions of consent?			<input type="checkbox"/> Yes <input type="checkbox"/> No
Is the system positioned according to council requirements for buffer distances?			<input type="checkbox"/> Yes <input type="checkbox"/> No
Is the system positioned according to Council design requirements for contours and slope?			<input type="checkbox"/> Yes <input type="checkbox"/> No

Is there an indication of poor drainage on or near the system area?		<input type="checkbox"/> Yes	<input type="checkbox"/> No
Has a diversion berm/ drain been installed above the system?		<input type="checkbox"/> Yes	<input type="checkbox"/> No
Does the system have good exposure to wind and sun?		<input type="checkbox"/> Yes	<input type="checkbox"/> No
For mounds - Has a turfed cover been established over the system surface?	<input type="checkbox"/> N/A	<input type="checkbox"/> Yes	<input type="checkbox"/> No
For mounds and sand filters - Have at least two inspection ports been incorporated into the system?	<input type="checkbox"/> N/A	<input type="checkbox"/> Yes	<input type="checkbox"/> No
Does the system include any non-standard elements in its design?		<input type="checkbox"/> Yes	<input type="checkbox"/> No
If yes, describe:			
Note: the checklist for the septic tank and any pump well will also need to be completed.			
Comments, actions or repairs required: (Where a response in the above Checklist needs extra information or action, specify the action plan and/ or the process to fix the problem, or specify an alternative that is being offered)			
Service provider and contact number:			
Inspector and contact number:			
Signature:		Date:	

OWM Effluent Application Area (EAA) Installation Inspection Checklist for use by Installers and Council

(Adapted from Designing and Installing On-site Wastewater Management Systems from WaterNSW, 2023a)

Site owner:			
Address & Lot/ DP:			
Installer/ Council Reference ID:			
Installation date:			
EAA system coordinates:			
EAA System Description:			
<input type="checkbox"/> Absorption bed	<input type="checkbox"/> ETA bed	<input type="checkbox"/> LPED	<input type="checkbox"/> SI
<input type="checkbox"/> Absorption trench	<input type="checkbox"/> Wick system	<input type="checkbox"/> SSI	<input type="checkbox"/> Other (specify):
Comment:			
Pre-construction considerations			
Is the soil moisture too wet for construction?	<input type="checkbox"/> Yes	<input type="checkbox"/> No	
EAA marked according to site plan/ conditions of consent including buffer and setback distances/ parallel to site contours?	<input type="checkbox"/> Yes	<input type="checkbox"/> No	
EAA Dimensions			
Basal effluent application area:	m ²		
Number of trenches/ beds or zones:			
Width & Length (trenches/ beds):	m (W) x	m (L)	
Surface Area (zones):	m ²		
Depth (all systems):	m		
EAA dimensions consistent with council's consent	<input type="checkbox"/> Yes	<input type="checkbox"/> No	
Confirm all system elevations	<input type="checkbox"/> Yes	<input type="checkbox"/> No	
Stake EAA boundaries with elevations	<input type="checkbox"/> Yes	<input type="checkbox"/> No	
Method of excavation:			
Absorption systems, ETA Beds and Wick systems:			
Trench/ bed bottom graded to specifications	<input type="checkbox"/> Yes	<input type="checkbox"/> No	
Inspection ports			
Type:	Diameter:		
	mm		
Perforations	<input type="checkbox"/> Slotted	<input type="checkbox"/> Drilled	

Grade from tank to trench/ bed		<input type="checkbox"/> Above grade (a pump will be required)	<input type="checkbox"/> Below grade
Media	<input type="checkbox"/> Gravel	<input type="checkbox"/> Sand	<input type="checkbox"/> Other (specify):
Media size and source:	Cleaned and graded	<input type="checkbox"/> Yes	<input type="checkbox"/> No
Total media depth:	mm	Total amount of media used:	m ³
Dosing system			
<input type="checkbox"/> Gravity	<input type="checkbox"/> Pressure (Pump)	<input type="checkbox"/> Low-pressure (Flout/ Siphon)	
Describe:			
Distribution system			
<input type="checkbox"/> Flood-loaded (gravity fed)		<input type="checkbox"/> Distribution box (gravity/ low-pressure fed)	
<input type="checkbox"/> Automatic sequencing valve (pressure fed)		<input type="checkbox"/> Other (specify):	
Describe:			
Distribution system access	<input type="checkbox"/> None (surface)	<input type="checkbox"/> Riser	<input type="checkbox"/> Other (specify):
Pressure manifold	Specification:		
Laterals feed configuration			
<input type="checkbox"/> End	<input type="checkbox"/> Top	<input type="checkbox"/> Centre	<input type="checkbox"/> Bottom
<input type="checkbox"/> Other (specify):			
Type			
Diameter:	mm	Length:	m
Orifice specifications/ spacing/ size/ orientation (describe):			
Access/ protection	<input type="checkbox"/> Yes	<input type="checkbox"/> No	Describe:
Laterals			
Specification:		Type:	
Diameter:	mm	Spacing:	mm
		Length:	mm
Installation			
Geotextile fabric cover placed over media	<input type="checkbox"/> Yes	<input type="checkbox"/> No	
Subsurface Irrigation and LPED Irrigation Systems			
Headworks			
Is the control panel/ controller installed according to manufacturer's instructions and the irrigation system design details?	<input type="checkbox"/> Yes	<input type="checkbox"/> No	<input type="checkbox"/> N/A

Is a foot valve fitted to the suction inlet in the effluent tank?	<input type="checkbox"/> Yes	<input type="checkbox"/> No	<input type="checkbox"/> N/A
Is an appropriate pump installed according to the manufacturer's specifications and/ or the irrigation system design requirements?	<input type="checkbox"/> Yes	<input type="checkbox"/> No	
Is a standby pump available for the system?	<input type="checkbox"/> Yes	<input type="checkbox"/> No	
If yes, has it been installed, or stored or available within 24 hours?	<input type="checkbox"/> Yes	<input type="checkbox"/> No	<input type="checkbox"/> N/A
Is a permanent pressure gauge installed following the pump?	<input type="checkbox"/> Yes	<input type="checkbox"/> No	
Is a non-return valve installed following the pressure gauge?	<input type="checkbox"/> Yes	<input type="checkbox"/> No	
Is an appropriate filter with 100-150 micron filter installed?	<input type="checkbox"/> Yes	<input type="checkbox"/> No	
Are any solenoid valves, cabling, sequencing or Manual valves installed to enable alternate dosing of the irrigation fields according to the design?	<input type="checkbox"/> Yes	<input type="checkbox"/> No	
Is the controller capable of operating the specified pump, filter and any solenoid valves for the irrigation fields according to the design?	<input type="checkbox"/> Yes	<input type="checkbox"/> No	
Has the controller been tested to operate satisfactorily for each field?	<input type="checkbox"/> Yes	<input type="checkbox"/> No	
Is a low level cut-off float switch installed in the effluent tank that overrides the irrigation controller to prevent the system pumping dry?	<input type="checkbox"/> Yes	<input type="checkbox"/> No	<input type="checkbox"/> N/A
Is a high level cut-in float switch installed in the effluent tank that overrides the standard irrigation schedule during times of high flow?	<input type="checkbox"/> Yes	<input type="checkbox"/> No	<input type="checkbox"/> N/A
Have the headworks been installed and located according to the design?	<input type="checkbox"/> Yes	<input type="checkbox"/> No	
Do the headworks meet the hydraulic specifications of the design?	<input type="checkbox"/> Yes	<input type="checkbox"/> No	
Mainline and dosing pipeworks			
Does all pipework match the size, pressure class specifications detailed in the design?	<input type="checkbox"/> Yes	<input type="checkbox"/> No	
Is all pipework installed, tested and commissioned according to AS/NZS 2566.2:2002?	<input type="checkbox"/> Yes	<input type="checkbox"/> No	
Are all pipe fittings, clamps and joints made to match the pressure class of the pipe at that location?	<input type="checkbox"/> Yes	<input type="checkbox"/> No	
Drip line and field layouts (SSI only)			
Is all installed drip line according to the design (e.g. pressure compensating, anti-siphon) with 0.6m dripper spacings and 1.6 L an hour dripper flow rate?	<input type="checkbox"/> Yes	<input type="checkbox"/> No	
Is all dripline installed under mulch or soil according to the hydraulic design?	<input type="checkbox"/> Yes	<input type="checkbox"/> No	

Are dripline laterals spaced between 0.6–1m (ideally 0.6m spacings)?	<input type="checkbox"/> Yes	<input type="checkbox"/> No	
Do all laterals comply with appropriate buffer distances?	<input type="checkbox"/> Yes	<input type="checkbox"/> No	
Are the connections of laterals to mainlines, sub-mains and flushing manifolds according to the manufacturer's recommendations?	<input type="checkbox"/> Yes	<input type="checkbox"/> No	
Is all dosing and flushing pipework according to the manufacturer's recommendations?	<input type="checkbox"/> Yes	<input type="checkbox"/> No	
Are air/ vacuum release valves installed at all significant high points in each field?	<input type="checkbox"/> Yes	<input type="checkbox"/> No	
Is a flushing valve installed at the end of each flushing manifold as recommended by the manufacturer?	<input type="checkbox"/> Yes	<input type="checkbox"/> No	
Has the field flush valve been connected back to the treatment system?	<input type="checkbox"/> Yes	<input type="checkbox"/> No	
Has the field flush valve been directed to a small absorption trench (approximately 3 m x 0.6 m)?	<input type="checkbox"/> Yes	<input type="checkbox"/> No	
Does each field have the facilities for measurement of pressure (e.g. needle test point or similar) immediately before the entrance to the first lateral and immediately following the exit of the final lateral?	<input type="checkbox"/> Yes	<input type="checkbox"/> No	
Do the installed dripline subsections meet the hydraulic specifications detailed in the design?	<input type="checkbox"/> Yes	<input type="checkbox"/> No	
Is the operating pressure at the pump within 10% of that specified for each field at the time of commissioning?	<input type="checkbox"/> Yes	<input type="checkbox"/> No	
Is the operating pressure at the pump within 10% of the design value?	<input type="checkbox"/> Yes	<input type="checkbox"/> No	
Is the pressure difference between the entrance to the first lateral and exit of the last lateral less than 15%?	<input type="checkbox"/> Yes	<input type="checkbox"/> No	
Are all flushing velocities greater than 0.4m/s for all fields?	<input type="checkbox"/> Yes	<input type="checkbox"/> No	
Commissioning and testing			
Has the pump, filter and control equipment been commissioned and tested according to the manufacturer or supplier specifications?	<input type="checkbox"/> Yes	<input type="checkbox"/> No	
Have all mainlines and sub-mains been commissioned and tested according to AS/NZS 2566.2:2002?	<input type="checkbox"/> Yes	<input type="checkbox"/> No	
Have all drip line field layout, connections and fittings been checked before covering?	<input type="checkbox"/> Yes	<input type="checkbox"/> No	
Have all fields been flushed with clean water adequately before pressurising to remove construction debris that may have accumulated during installation?	<input type="checkbox"/> Yes	<input type="checkbox"/> No	

Have all drip line fields been tested for leakage from joints and fittings before covering?	<input type="checkbox"/> Yes	<input type="checkbox"/> No	
Have all operating pressures been checked at the pump and the end of each field or subsection at the time of commissioning according to the design?	<input type="checkbox"/> Yes	<input type="checkbox"/> No	
Has Council inspected the system before backfilling?	<input type="checkbox"/> Yes	<input type="checkbox"/> No	
Has the owner/ operator been provided with an Operation and Maintenance Manual, including layout?	<input type="checkbox"/> Yes	<input type="checkbox"/> No	
Surface Irrigation Systems			
Are appropriate authorised fittings used as part of the system?	<input type="checkbox"/> Yes	<input type="checkbox"/> No	
Fixed sprinkler type	<input type="checkbox"/> Bayonet	<input type="checkbox"/> Pop-up	<input type="checkbox"/> Other (specify):
Sprinkler head type (specify):			
Sprinkler plume height:	mm	Sprinkler throw:	mm
Are the sprinklers appropriately spaced given their throw and plume height?	<input type="checkbox"/> Yes	<input type="checkbox"/> No	
Do the sprinklers receive uniform amounts of effluent?	<input type="checkbox"/> Yes	<input type="checkbox"/> No	
Have Manual or automatic sequencing valves been installed?	<input type="checkbox"/> Yes	<input type="checkbox"/> No	
Has a disc filter been installed upstream of any sequencing valve?	<input type="checkbox"/> Yes	<input type="checkbox"/> No	
Have air, pressure-reducing and/ or non-return valves been incorporated into the design (as needed)?	<input type="checkbox"/> Yes	<input type="checkbox"/> No	
Does the irrigation system have a flushing valve?	<input type="checkbox"/> Yes	<input type="checkbox"/> No	
Does the flushing line return to the wastewater treatment system (not the primary chamber)?	<input type="checkbox"/> Yes	<input type="checkbox"/> No	
Is the flushing line directed to a small absorption pit?	<input type="checkbox"/> Yes	<input type="checkbox"/> No	
Has the pump sufficient capacity to service the demands of the effluent irrigation area and overcome friction and head losses in the system?	<input type="checkbox"/> Yes	<input type="checkbox"/> No	
Is the effluent distribution line from the tank to the effluent irrigation area buried at an appropriate depth (minimum 300mm) and in a manner that provides protection against mechanical damage or deformation?	<input type="checkbox"/> Yes	<input type="checkbox"/> No	
Are the distribution laterals buried at a depth of between 100-150mm?	<input type="checkbox"/> Yes	<input type="checkbox"/> No	

Has the irrigation area been protected to prevent damage (e.g. using fencing)?	<input type="checkbox"/> Yes	<input type="checkbox"/> No	
All Systems			
Depth of final topsoil cover:	mm		
Imported material needed	<input type="checkbox"/> Yes	<input type="checkbox"/> No	
Nature of material (describe; should be clay loam – sandy loam):			
Stormwater diversion berm/ drain where needed	<input type="checkbox"/> Yes	<input type="checkbox"/> No	
Grass vegetation cover established over site:			
Comments, actions or repairs required: (Where a response in the above Checklist needs extra information or action, specify the action plan and/ or the process to fix the problem, or specify an alternative that is being offered)			
Service provider and contact number:			
Inspector and contact number:			
Signature:		Date:	

OWM Treatment and Effluent Application Area System Operational Inspection for Councils

(Adapted from *Designing and Installing On-site Wastewater Management Systems from WaterNSW, 2023a*)

Site Owner:			
Address & Lot/ DP:			
Council reference ID:			
Inspection date:			
Treatment system coordinates:		Effluent application area coordinates:	
Who is present on site?	<input type="checkbox"/> Owner	<input type="checkbox"/> Tenant	<input type="checkbox"/> No one
Occupancy type?	<input type="checkbox"/> Owner	<input type="checkbox"/> Tenant	<input type="checkbox"/> Vacant <input type="checkbox"/> Unknown
Number of bedrooms:		Number of residents:	
System services?	<input type="checkbox"/> Dwelling	<input type="checkbox"/> Shed	<input type="checkbox"/> Other (specify):
Water supply?	<input type="checkbox"/> Tank	<input type="checkbox"/> Reticulated	<input type="checkbox"/> Bore
Other OWMS on property?	<input type="checkbox"/> Yes	<input type="checkbox"/> No	<input type="checkbox"/> Unknown
Existing risk category	<input type="checkbox"/> High	<input type="checkbox"/> Medium	<input type="checkbox"/> Low
Reassess risk rating?			
Is there danger to the inspector from people, animals or structural risk?			
Is there localised flood potential?		Nearest watercourse (m)?	
Treatment system type:		EAA type:	
<input type="checkbox"/> Septic tank	<input type="checkbox"/> AWTS	<input type="checkbox"/> Trench/ bed <input type="checkbox"/> SSI	<input type="checkbox"/> SI

<input type="checkbox"/> Reed bed/ sand filter	<input type="checkbox"/> Composting (wet/ waterless)	<input type="checkbox"/> LPED	<input type="checkbox"/> Mound/ raised bed <input type="checkbox"/> Other (specify):
Describe: Capacity (L): Material: Manufacturer: Model #: Service (last/ next):	Describe: System configuration: System dimensions:		
Treatment Tank(s)			
Does treatment system meet approved design?	<input type="checkbox"/> Yes	<input type="checkbox"/> No	<input type="checkbox"/> Unknown
Access to tank:	Tank condition:		
<input type="checkbox"/> Available <input type="checkbox"/> Vegetation overgrown <input type="checkbox"/> Animal risk <input type="checkbox"/> Locked/ fenced off <input type="checkbox"/> Built over/ covered	<input type="checkbox"/> Good <input type="checkbox"/> Gap in lid/ tank <input type="checkbox"/> Soil/ water access into tank <input type="checkbox"/> Tank/ lid cracked/ unsound <input type="checkbox"/> Evidence of leaks		
Inside tank: <input type="checkbox"/> Operational <input type="checkbox"/> Wastewater level incorrect operational levels <input type="checkbox"/> T-pieces/ baffle/ chambers missing/ damaged <input type="checkbox"/> Solids need desludging <input type="checkbox"/> Scum/ crust mounded <input type="checkbox"/> Outlet filter blocked <input type="checkbox"/> Roots/ foreign objects in tank	Pipes & pumps (pump wells or irrigation chamber): <input type="checkbox"/> Pipes good <input type="checkbox"/> Pipes damaged/ leaking <input type="checkbox"/> Vent not vermin proof <input type="checkbox"/> Pump well operational <input type="checkbox"/> Pump not working <input type="checkbox"/> Alarm not working <input type="checkbox"/> Filter dirty/ blocked/ missing <input type="checkbox"/> Filter inappropriate for irrigation		

<p>Aeration/ tricking filter:</p> <ul style="list-style-type: none"> <input type="checkbox"/> Operational <input type="checkbox"/> Blower not operating/ noisy <input type="checkbox"/> Diffusers not operational <input type="checkbox"/> Insufficient air (dissolved oxygen) <input type="checkbox"/> Colour/ odour poor <input type="checkbox"/> Fixed media detached/ floating <input type="checkbox"/> Recirculation pump failed <input type="checkbox"/> Sprays not operational 	<p>Clarification & disinfection:</p> <ul style="list-style-type: none"> <input type="checkbox"/> Operational <input type="checkbox"/> Sludge return off/ damaged <input type="checkbox"/> Effluent quality poor (turbidity) <input type="checkbox"/> Scum/ sludge present <input type="checkbox"/> Chlorinator not operational <input type="checkbox"/> Chlorine tablets empty <input type="checkbox"/> UV not operational
<p>Comments:</p>	
<p>Reed bed systems</p>	
<ul style="list-style-type: none"> <input type="checkbox"/> Operational <input type="checkbox"/> Ponding liquid at surface <input type="checkbox"/> Stormwater intrusion 	<ul style="list-style-type: none"> <input type="checkbox"/> Overgrown/ dead reeds <input type="checkbox"/> Leaking pod/ pipes <input type="checkbox"/> Other:
<p>Comments:</p>	
<p>Compost systems</p>	
<p>Compost toilet:</p> <ul style="list-style-type: none"> <input type="checkbox"/> Operational <input type="checkbox"/> CT instruction notice not operational <input type="checkbox"/> Ventilation poor <input type="checkbox"/> Exhaust fan not operational <input type="checkbox"/> Suitable bulking agent (carbon source) missing 	<p>Compost chamber:</p> <ul style="list-style-type: none"> <input type="checkbox"/> Operational <input type="checkbox"/> Adequate worm activity (WCS only) <input type="checkbox"/> Access for humus removal poor <input type="checkbox"/> Humus pile wet/ smelly <input type="checkbox"/> Humus needs removing <input type="checkbox"/> Drain blocked

Humus disposal				
<input type="checkbox"/> Suitable areas available and in use <input type="checkbox"/> No suitable burial sites available on property <input type="checkbox"/> Alternative composting available on property				
Comments:				
Effluent Application Area (EAA)				
Does EAA meet approved design?		<input type="checkbox"/> Yes	<input type="checkbox"/> No	<input type="checkbox"/> Unknown
EAA condition: <input type="checkbox"/> Well maintained <input type="checkbox"/> Vegetation overgrown <input type="checkbox"/> Uneven growth (poor distribution) <input type="checkbox"/> Stormwater intrusion <input type="checkbox"/> Vehicle/ stock damaged <input type="checkbox"/> Inspection ports damaged/ flooded <input type="checkbox"/> Air release/ flush points operational		Distribution system: Type (specify): _____ <input type="checkbox"/> Good <input type="checkbox"/> Damaged <input type="checkbox"/> Sludge/ soil present <input type="checkbox"/> Uneven distribution (blocked outlets/ tilted box/ failed operation) <input type="checkbox"/> Stormwater ingress		
Access to EAA: <input type="checkbox"/> Available <input type="checkbox"/> Unknown location/ no wet areas <input type="checkbox"/> Vegetation blocking access <input type="checkbox"/> Animal risk <input type="checkbox"/> Locked/ fenced off		EAA moisture: <input type="checkbox"/> Good <input type="checkbox"/> Pooling effluent/ soft wet ground (smell, colour, dye test) <input type="checkbox"/> Open pipe disposal (dye test) <input type="checkbox"/> Inspection ports damaged/ flooded		
Comments:				

Comments, actions or repairs required: (Where a response in the above Checklist needs extra information or action, specify the action plan and/ or the process to fix the problem, or specify an alternative that is being offered)

Service provider and contact number:

Inspector and contact number:

Signature:

Date:

Draft

Inspection Equipment Checklist

- A sense of self-preservation. If it looks dodgy, don't do it! If the gate is locked, leave a calling card with a contact number and come back, even if you can go over.
- Your investigator hat for finding everything when you don't usually have a site plan and finding things that look out of place (fresh soil over an EAA, the long green grass, the odd looking post in the paddock).
- An approachable attitude. Your attitude will often impact how people react to you when they answer the door.

Items may include the following:

- Council authorised officer card and name badge
- Safety checklist (JSA/ Take-5)
- PPE:
 - Disposable gloves
 - Safety gloves for manual handling
 - Safety glasses
 - Protective safety shoes suitable for uneven ground
 - Sun protection (sunscreen, hat, long sleeves/ pants)
 - Insect protection (long sleeves/ pants, insect repellent). These also help with weed seeds
 - Gumboots (wet weather and failing EAA)
- Snake bite kit and first aid kit (insect bites and cuts and scratches happen)
- Sanitiser and bleach (cleaning hands and tools)
- Water (washing hands and tools)
- Paper towel ("dry washing" tools)
- Inspection log sheet (paper or digital) plus inspection job list
- Council calling cards and missed inspection letters to be left on the site if no-one is home and/ or access wasn't possible and a reinspection date needs to be arranged
- Camera or mobile phone for taking photographs
- GPS for component location coordinates
- Basic tools:
 - Screwdrivers (small and large flat-head and Phillips head for opening/ closing screws, levering small inspection openings and clearing dirt from screw heads)
 - Socket set
 - Battery drill with screwdriver and sockets (can save a lot of time)
 - Lid lifter or multi-grips for lifting lids. Include a 20c coin for opening some poly septic tank inspection caps
 - Shifters (just in case the sockets don't fit)
 - Hammer (rubber/ wood to persuade stuck fittings)
 - Hook for lifting floats and lids
 - Wrecking bar (levering and lifting concrete lids)
 - Lid lifter (suited for 'T' shaped lifting points)
 - Crowbar (for moving concrete lids)
 - Torch (high light output but small, floating or tethered)
 - Sludge measuring device (Sludge Judge, PVC pipe with marked graduations and filled ends)
 - Measuring tape and measuring wheel
 - Dye for checking flow paths. More than one colour is good (e.g. Fluorescein and Rhodamine)
 - Bucket(s)
 - Sample bottles for water quality sampling (plastic and sterile and preserved for chlorine treated effluent)
 - Permanent marker for marking sample bottles
 - Free residual chlorine test kit and pH strips
 - Nessler's reagent (detects ammonia rich water)
 - Turbidity tube
 - Imhoff cone or equivalent (activated sludge plants)
 - Dissolved Oxygen (DO) and nutrient (N and P) test kits

Appendix 8:

Model Onsite Wastewater Management Strategy

Appendix 8. Model Onsite Wastewater Management Strategy

A8.1. Overview

Councils have primary responsibility for controlling onsite sewage management facilities in their areas and are given a wide range of powers and functions for this purpose. These include general community leadership, land use planning, development control, regulation of activity, and the provision of onsite wastewater management services. Preparing an onsite wastewater management strategy (OWMS) is an effective way to set objectives and prioritise resources.

The OWMS should take into consideration related strategies for water supply, sewerage and stormwater management, as well as catchment management plans and the views of community stakeholders and of councils of neighbouring areas (especially those within the same water catchment). The OWMS should be supported by a full assessment of the nature and impact of existing onsite wastewater management systems and of the environmental and social factors affecting system performance.

The OWMS should include:

- a statement of the objectives for on-site sewage management in the council's area
- a statement of specific on-site sewage management goals
- a statement of programs and resources to achieve those goals
- a statement of the evaluation processes to be adopted in relation to those programs
- a commitment to continuing improvement of on-site sewage management in the council's area.

The Office of Local Government has reviewed a number of councils' existing Strategies in developing this Model Strategy for consideration by councils when reviewing their current Strategies. The final form and content of any updated Strategy is a matter for council decision.

Refer to Section 2 of these Guidelines for further information on what to include in your Strategy based on individual circumstances, for example, restrictions on designs in certain circumstances, subdivisions or any cumulative impact risk areas.

A8.2. Model Strategy

A8.2.1. Introduction

[An introductory section should be provided, including background information on the development of the OWMS and its status, when it was adopted and when it came into effect.]

A8.2.2. Statement of Purpose

The purpose of this OWMS is to:

- provide a framework to manage and regulate the impact of onsite wastewater management systems in [LGA name] through efficient monitoring, regulation and community education that minimises risk to public health and the environment,
- provide guidance to homeowners, applicants, installers, wastewater consultants, service technicians and developers on all aspects of onsite wastewater management systems.

A8.3. Objectives

The general objectives of this Strategy plan are:

- To ensure the protection of the surrounding environment including groundwater, surface water, land and vegetation through the selection and maintenance of a system suitable for that particular site.
- To aid in the prevention of public health risk from onsite wastewater disposal.
- To ensure recognition of the value of wastewater and the maximum reuse of resources.
- To ensure ecologically sustainable development.
- To outline an ongoing monitoring and inspection program.

A8.3.1. Goals

[delete what isn't applicable / add your own]

- to ensure that onsite wastewater systems are designed by suitably qualified and experienced professionals who are in possession of appropriate professional indemnity insurance,
- to ensure that onsite wastewater system designs are assessed and approved by suitably qualified and experienced staff,
- to adopt a partnership approach with households and service agents to support continual improvement of onsite wastewater management,
- to ensure that all service agents are appropriately qualified, experienced and insured as outlined in NSW Health Advisory Note 5 – February 2018,
- to inspect all onsite wastewater management systems at regular intervals based on risk, are desludged and maintained as required,
- to build and maintain a database of all existing onsite wastewater management systems,
- to determine the structures and facilities needed to support onsite wastewater management systems,
- to map and maintain details of soil and site conditions and suitability for onsite wastewater management systems
- to provide education for operators of onsite wastewater management systems,
- to consult with householders on the development and implementation of a strategy to eliminate illegal discharges from pump-out systems,
- to consult local plumbers and service agents and to specify qualifications for third party certification of maintenance work and compliance with approval standards,
- to ensure that all land application areas comply with environment and health protection standards and council operating requirements,
- to consult Aerated Wastewater Treatment System service agents and to ensure that maintenance reports also certify that land application of effluent is being done in compliance with site requirements,
- in cooperation with householders, to develop a site-specific wastewater management plan for each household using an onsite wastewater management system,

- to review council development standards and approval criteria for subdivision, development and building to ensure that appropriate provision is made for sustainable onsite wastewater management when residential development occurs in non-sewered areas.,
- to reduce the frequency of system failure as a result of householder misuse.

A8.4. Programs and Resources

[The Programs and Resources section of the OWMS should specify the action to be taken to achieve specific goals and general objectives. It might help to distinguish between environmental assessment, monitoring programs, regulatory programs, service programs and educational programs. It is also appropriate to identify non-council inputs in this section.]

Inspection Program

The circumstances in which Council will inspect an OWMS are as follows:

- Periodic inspection of an existing OWMS,
- Reinspection of an existing OWMS due to failure, modification or upgrade - for example, when there is an increase in density (extension or additional dwelling),
- Initial inspection of a new system,
- Council becomes aware of a potentially failing OWMS.

To determine the inspection frequency, all OWMS within the [insert council name] area are classified into a rating of either low, medium or high risk depending on the potential public health or environmental risk they pose. The main considerations in determining risk include:

- Location (for example, proximity to environmentally sensitive areas or water catchment areas) and size of the land,
- system design / technology type, condition and observed performance,
- the amount of wastewater generated,
- soil type,
- vegetation coverage,
- slope of the land,
- distance to watercourses, drains and property boundaries,
- concentration of systems,
- surface or subsurface discharge of effluent,
- risk of flooding,
- the operation of any home-based businesses,
- compliance history of applicant.

The risk rating will determine the Approval to Operate expiration, renewal date and inspection frequency. The higher the risk rating, the greater the inspection frequency for that property. Risk ratings can be re-assessed from time to time, such as when conditions change, the system operation is improved or the system is upgraded. Council may increase the risk rating of any OWMS if determined upon inspection that more frequent monitoring of the system is required.

It should be noted that where an OWMS, which is classified as low or medium risk, fails to operate in accordance with the performance standards of its approval, such a system will automatically be re-categorised to a higher risk system. This re-categorisation will not apply where the system is maintained and repaired so that it again meets the required performance standards within a nominated period of such failure.

Inspection fees are listed in Council's revenue policy [\[link\]](#), with revenue raised being put back into the regulation and management of OWMSs in [LGA name].

The Local Government (General) Regulation 2021 sets out performance criteria that Council must consider:

- preventing the spread of disease by micro-organisms,
- preventing the spread of foul odours,
- preventing contamination of water,
- preventing degradation of soil and vegetation,
- discouraging insects and vermin,
- ensuring that persons do not come into contact with untreated sewage or effluent (whether treated or not) in their ordinary activities on the premises concerned,
- the re-use of resources (including nutrients, organic matter and water),
- the minimisation of any adverse impacts on the amenity of the land on which it is installed or constructed and other land in the vicinity of that land.

Inspection Program

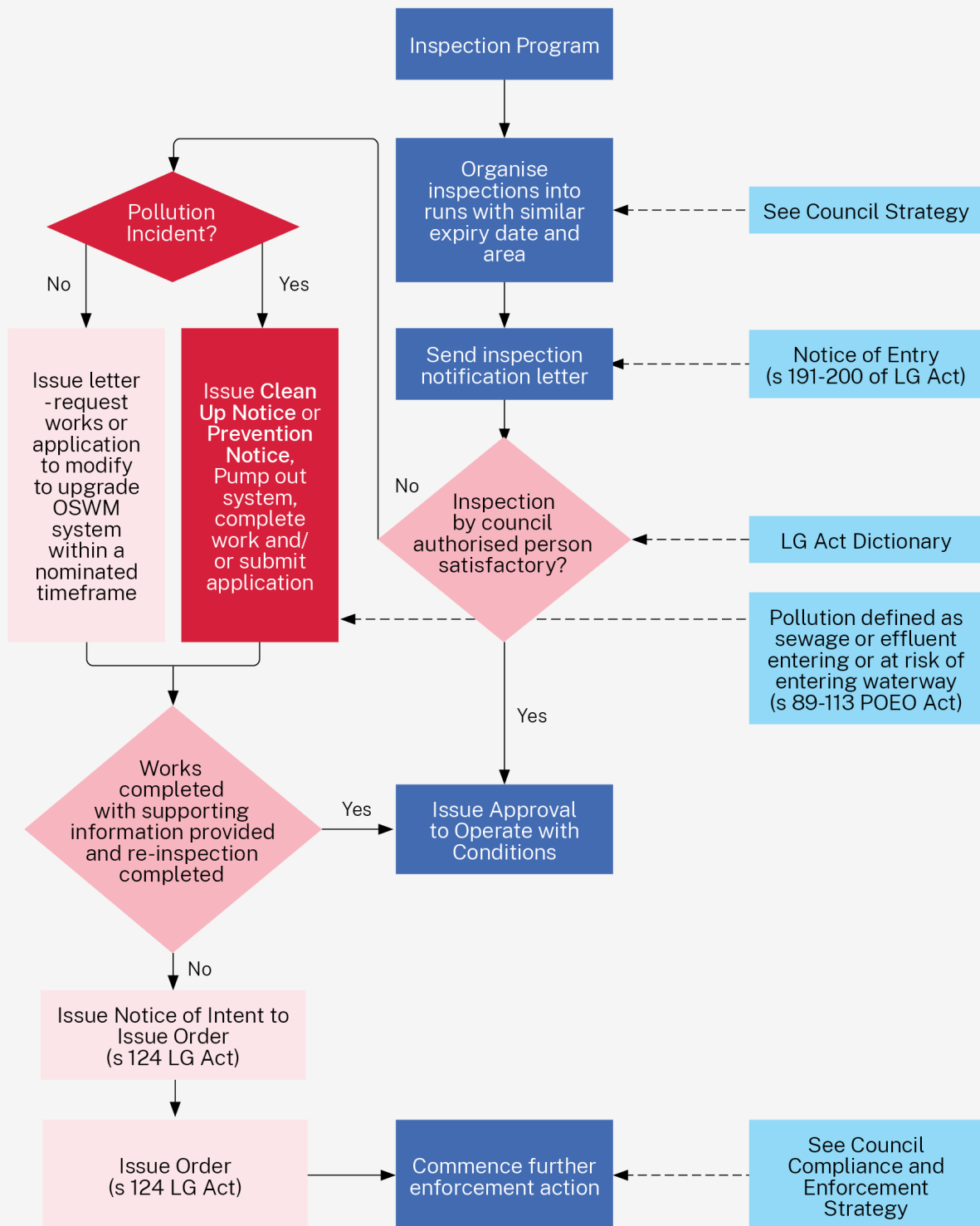

Approvals applications

Operating an onsite wastewater management system is a prescribed activity under Section 68 of the *Local Government Act 1993* (LG Act). This means that an approval to operate such a system must be obtained from Council. The approval requires households to meet environment and health performance standards when operating their systems and allows Council to monitor these systems to ensure these standards continue to be met.

The following onsite wastewater management systems are not acceptable in [Council] LGA [remove if not applicable]:

→ [list systems]

Applications to [Council] for the installation of an onsite wastewater management system or an upgrade to an existing system are subject to two separate approvals:

- an approval to install, construct or alter an onsite wastewater management system, and
- an approval to operate an onsite wastewater management system.

The application to install, construct or alter a wastewater management system is required to be submitted to Council with the appropriate fees for Council approval prior to any works commencing. Single residential wastewater management systems must be accredited by NSW Health where appropriate

The approval to operate an onsite wastewater management system is issued after Council has undertaken a final inspection of the installation works and the works are to the satisfaction of Council.

It is an offence under the LG Act to undertake work to install or alter an onsite wastewater management system without prior written approval by Council and an offence to operate an onsite wastewater management system without Council approval.

At a minimum, all applications to install or alter onsite wastewater management systems shall include:

- application form (if applicable, e.g. if not part of a broader development application)
- a site plan detailing location of system, land application area, drainage lines and distances to buildings, property boundaries and any environmentally sensitive area,
- details of the OWMS to be installed and corresponding Certificate of Accreditation from NSW Health, as well as supporting calculations
- floor plans clearly showing the number of bedrooms in the dwelling, including any secondary dwellings such as granny flats,
- a detailed wastewater report / site assessment prepared by a suitably qualified and experienced wastewater consultant outlining how the system will comply with the relevant legislation and guidelines in line with the amount of suitable wastewater disposable area available (councils may wish to specify requirements for wastewater reports to accompany applications),
- certification by the designer that the proposed system meets the requirements of the NSW Guidelines, Australian Standards and industry best practice and that the design is warranted by the designer.

Accreditation for Secondary Treatment Systems - including Aerated Wastewater Treatment System (AWTS)

Accredited Maintenance Operators (or service agents) servicing domestic AWTS's are required to satisfy Council that they possess adequate skills and knowledge to maintain such systems. Any maintenance operator wishing to service AWTS's within the [insert council name] LGA must provide Council with appropriate documentation demonstrating satisfactory completion of a relevant training course as well as relevant experience prior to commencing operations and that they are in possession of current insurance to cover their work.

Education

Council recognises its responsibility to provide appropriate information to owners. This will be through Council's inspection program which will include informal education of owners onsite and distribution of information and fact sheets when required. Information will also be provided on Council's website.

Enforcement

In circumstances where OWMS's are causing health and/or environmental problems, Council will take action by using its legislative powers. This may include the use of Notices and Orders to require certain works to be undertaken or the issuing of fines.

Notices and Orders can be issued under the *Local Government Act 1993* directing owners to undertake such remedial action as necessary to ensure that the system is operating correctly or requiring the premises to be connected to the reticulated sewerage scheme if available. Various Notices can be issued under the *Protection of the Environment Operations Act 1997* (POEO Act). On the spot fines can be issued for non-compliance with an Order or for potentially causing water pollution under the POEO Act.

Enforcement action may be carried out as a result of failure of a routine inspection, random inspections, or through the follow up of complaints or reported incidents.

Resourcing

[add detail on how the strategy will be resourced, including staffing and what services or activities attract a fee/charge]

A8.5. Evaluation

[Council name] recognises the importance of continuous improvement of our regulatory functions. This Strategy will be reviewed every X years. The following performance indicators will be used to measure the success of this Strategy and where improvements can be made, as well as to account for new technology.

[delete what isn't applicable / add your own]

Goals	Performance Indicator/Target
To survey and maintain a database of all existing systems	<ul style="list-style-type: none"> • number of surveys entered each year • proportion of total entered each year • complete surveys of 75% of existing systems within three years
To provide education for households on effective maintenance of OWMSs.	<ul style="list-style-type: none"> • develop a communications strategy that details how educational activities will be delivered to householders.
To ensure that land application areas comply with management requirements	<ul style="list-style-type: none"> • Specify requirements for land application areas • Develop and implement effective inspection and enforcement strategies
To ensure all septic tanks are inspected by qualified people at regular intervals and are desludged and maintained as required for effective performance	<ul style="list-style-type: none"> • develop and implement maintenance policies for all septic tanks in two years • no fewer than 95% of all septic tanks to be desludged at least once every five years

A8.5.1. Appendices

[Although the OWMS is essentially a strategic management document, it might be appropriate to include or reference technical guidelines (for example, for site assessment, irrigation area calculations, system selection, operation and monitoring) as appendixes.]

You may also wish to include a glossary to explain any difficult or uncommon terminology.]

